

LPDT USER'S MANUAL



Xentaur Corporation

When calling your representative for technical support, please have your serial numbers available.

The Sensor and Instrument Serial Numbers are on the instrument, also see section 3.4.4.4.

Sensor Serial No.: _____

Instrument Serial No.: _____

Your Representative is:

COSA INSTRUMENT CORPORATION
55 Oak Street, Norwood, NJ 07648
Tel: 1(201) 767-6600 - Fax: 1(201) 767-6804
e-mail: cosa@cosaic.com

Except as may be provided by contract, this document and all specifications and drawings contained are the property of Xentaur Corporation, are issued in strict confidence, and shall not be reproduced or copied or transmitted, in any form or by any means, or used as the basis for the manufacture or sale of apparatus, programs, or services without permission.

Check the Internet for updates; the latest revision of this manual is available in Adobe Acrobat format at:
<http://www.xentaur.com>

Document No.: LDO.01.D.2000 Rev.0 6/1/99

Copyright © 1999 by Xentaur Corporation

Xentaur reserves the right to change or modify the product specification and / or appearance at any time without notice. Therefore, the information in this document is subject to change without notice and does not represent a commitment on the part of Xentaur Corporation.

The customer agrees that in accepting and using this instrument Xentaur Corporation's liability arising from or in any way connected with this instrument shall be limited exclusively to performing a new calibration or replacement or repair of the instrument or sensor, at Xentaur's sole option, as covered by Xentaur's warranty. In no event shall Xentaur be liable for any incidental, consequential or special damages of any kind or nature whatsoever, including but not limited to lost profits arising from or in any way connected with this instrument or items hereunder, whether alleged to arise from breach of contract, express or implied warranty, or in tort, including without limitation, negligence, failure to warn or strict liability.

Swagelok, Cajon are trademarks of SWAGELOK Co.

Acrobat is a trademark of Adobe Systems Incorporated

Microsoft Windows is a registered trademark of Microsoft Corporation

HTF is a trademark of Xentaur Corporation

SpanCheck is a trademark of Xentaur Corporation

The Xentaur Logo is a trademark of Xentaur Corporation

Examine the LPDT package for damage or mishandling. If any damage is evident notify the carrier and request an inspection.

Unpack the box, it should contain: The LPDT with sensor in desiccant container, connectorized cable, and this manual.

PLEASE READ THIS MANUAL IN WHOLE, PRIOR TO INSTALLING OR REMOVING THE SENSOR FROM ITS SHIPPING CONTAINER.

This manual is organized in three sections:

Section 1 is an overview of the LPDT.

Section 2 describes the sensor and sampling techniques.

Section 3 describes the instrument's electrical, mechanical, and user interfaces.

This manual is intended for those already familiar with the installation, use and maintenance of analytical or process instrumentation.

Those acquainted with other Xentaur dewpoint measurement products such as the XDT or the XPDM, will benefit from the commonality of the user interface.

Warranty

Xentaur instruments are warranted to be free from defects in workmanship and materials. Liability under this warranty is limited to servicing, calibrating, and replacing any defective parts of the instrument returned to the factory for that purpose. Fuses are specifically excluded from any liability. This warranty is effective from the date of delivery to the original purchaser. The equipment must be determined by Xentaur to have been defective for the warranty to be valid. This warranty applies as follows:

- one year for electronics
- one year for mechanical failures to the sensor
- six months for calibrations

If damage is determined to have been caused by misuse or abnormal conditions of operation, the owner will be notified and repairs will be billed at standard rates after approval.

Maintenance Policy

In cases when equipment fault is suspected, please notify your representative of the problem, be sure to provide them with model and serial numbers. If the problem can not be resolved, then ask for a Return Authorization Number (RAN) and shipping instructions. Issuance of an RAN does not automatically imply that the equipment is covered by our warranty, that will be determined after we receive the equipment. Pack the equipment in a suitable box with sufficient padding, include the RAN number on your paperwork, and send the equipment, prepaid, to the designated address. Xentaur will not accept equipment returned without an RAN, or with reversed shipping or import/export charges.

If the warranty has expired, or the damage is due to improper use or exposure of the equipment; then Xentaur will provide an estimate and wait for approval before commencing repairs.

For your convenience a Return Authorization Request Form is provided in appendix J, it must be filled out and sent back to Xentaur in order to obtain a RAN.

LPDT User's Manual Table of Contents

1.0 Overview of the LPDT	1
2.1 Precautions using the sensor	3
2.2 Sensor Technical Specifications	4
2.3 Sensor Installation & Sampling Techniques	4
2.3.1 In-situ Installation	5
2.3.2 Extractive Installation	7
2.4 Troubleshooting unexpected readings	9
3.1 Precautions using the LPDT	13
3.1.1 Electromagnetic Compatibility Considerations ..	13
3.2 Instrument Technical Specifications	14
3.3 Installation	15
3.3.1 Mechanical Installation	15
3.3.2 Electrical Installation	16
3.4 Operating the Instrument	17
3.4.1 Starting up	17
3.4.2 Display Conventions	17
3.4.3 Push Buttons	19
3.4.4 Operating State	19
3.4.4.1 Viewing Dewpoint Mode	20
3.4.4.2 Viewing Temperature at the Sensor	20
3.4.4.3 Start Calibration (SpanCheck™) Mode	21
3.4.4.4 Viewing Serial Number Mode	24
3.4.5 SetUp State	24
3.5 Troubleshooting the Instrument	28
Appendix A: Operating State User Interface flowchart	31
Appendix B: Set-Up State User Interface flowchart ...	32
Appendix C: LPDT Mechanical Drawing	34
Appendix D: LPDT Electrical Connections	35
Appendix E: Sensor/SpanCheck™ Theory of Operation	36
Appendix F: Pressure Correction	39
Appendix G: Current vs. Dewpoint	40

Appendix H: Uncertainty in LBS & ppmV calculations 43
Appendix I: Sensor Response Time44
Appendix J: Return Authorization Request45

1.0 Overview of the LPDT

The LPDT is a microprocessor based 4-20mA loop powered (2 wire) hygrometer, for measuring moisture content in gases in the range from -100°C to +20°C. The measurement is displayed on the instrument's custom LCD, and is transmitted by varying the current drawn (4-20mA) from the power supply. The current varies linearly proportional to the selected measurement units. An optional digital output is available which modulates/demodulates the 4-20mA loop line without interfering with its operation. With this option the LPDT is capable of communicating with properly equipped Personal Computers or other RS-232 capable controllers. Three front panel buttons provide the user with a wide variety of features. The LPDT's advanced design allows it to be housed in a small stainless steel enclosure behind the sensor probe, thus the instrument and sensor are a single integrated unit.

The LPDT uses the Xentaur HTF™ sensor which is encapsulated in sintered stainless steel, thus it is capable of coming into contact with a wide variety of environments. However one should keep in mind that the sensor is a sensitive device and it should be handled accordingly.

2.1 Precautions using the sensor

The Xentaur HTF™ Al₂O₃ sensor is designed and field proven to be highly reliable, rugged and maintenance free. However the user should consider the following precautions:

- To avoid the need for prolonged dry-down (when expecting to measure dewpoints dryer than -65°C), do not expose the sensor to room air longer than necessary (1 - 2 minutes). Thus, do not open the sensor container before you are ready to install the sensor.
- The sensor container has desiccant to keep the sensor dry during shipping and to avoid damage due to condensation. Close the container immediately after removing the sensor to avoid degradation of the desiccant.
- Do not throw away the sensor container, you may use it again to transport the sensor between locations, to store it between uses or to ship it back to the factory for certification. The container can be attached to the loop cable, by trapping the cable with the lid strap.
- Do not expose the sensor to corrosive gases such as gases containing chlorine, ammonia or HCl. (SO₂ can be monitored when the moisture content is low).
- Except for the XTR65W sensor:
 1. Do not expose the sensor to liquid water, as it may get damaged.
 2. Do not breathe directly onto the sensor, as condensation may form which could damage the sensor element.
- Do not install the sensor near heat sources such as radiators or air ducts.
- Do not install the sensor in places subject to extreme mechanical vibration or shock. If this is not avoidable, use resilient mounting. If in doubt, call your representa-

tive.

- Do not disassemble the porous metal filter encapsulation, as this will damage the sensor and void your factory warranty.
- Prior to installation of the probe, ensure that no contaminants are present in the system (e.g. oil, liquid water).

2.2 Sensor Technical Specifications

Type:Hyper Thin Film high capacitance Al_2O_3 .

Dewpoint range:

XTR-100-148°F to +68°F (-100°C to +20°C)

XTR-65-85°F to +68°F (-65°C to +20°C).

Capacitance:..... 15nF to 200nF.

Accuracy:±5.5°F (±3°C).

Repeatability:±0.9°F (±0.5°C).

Response time:see graph in Appendix I.

Temperature range:-10°C to +70°C.

Sample Flow range:

(linear velocity @ 1ATM):Static to 100m/s.

Storage temperature:-40°F to+176°F (-40°C to +80°C).

Mechanical:.....encapsulated in 100μ sintered stainless steel.

Calibration method:SpanCheck™, sensor saturates at dewpoint above +68°F (+20°C). NIST/NPL traceable multi-point factory calibration available optionally.

2.3 Sensor Installation & Sampling Techniques

Keep in mind that the moisture content at the sensor is not only due to the moisture of the gas being measured, but also due to desorption of water from tubing, trapped moisture (at the interconnection points, valves, filters and other hygroscopic materials in the system), leaks in the system, and others. Thus the measurement may vary from the expectation, and therefore care should be taken in choosing the sampling technique utilized in the measurement. Factors such as gas pressure, flow rate, materials of construction, length and

diameter of tubing, number of interconnecting fittings, dead space in tubing and manifolds; will influence the measurement value and response time.

The high capacitance HTF™ sensors can be installed either directly in the line to be sampled (in-situ), or in a slip stream of a sample system (extractive).

To assure a long and accurate performance of the sensor, it should be protected from contaminants such as liquids (water, oil etc.), and particulates. The sintered stainless steel sensor encapsulation protects from particulates larger than 100 microns, finer particulates (e.g. from degraded desiccant or rust) should be filtered with a particulate filter with suitable capability, do not use hygroscopic filter materials.

2.3.1 In-situ Installation

In-situ installation is recommended only for measurements where the gas pressure is expected to vary little, the gas is expected to be free of contaminants, the gas temperature is within the operating specifications of the sensor, and there is no chance of liquids coalescing. Examples of applications suited for in-situ installations are: pure gases, output of desiccant dryers (for instrument air), glove boxes, etc. For most other applications in-situ installation should be avoided for the following reasons:

- Sample conditioning is almost always necessary to avoid exposure of the sensor to liquid water and other contaminants, such as hydrocarbons, which may damage the sensor over time.
- Variations in line pressure affect the reading of the sensor because dewpoint varies with pressure.
- If the gas line is under pressure, it is more likely that water condensation occurs which may damage the sensor.

- Under a pressurized system removal of the sensor without the installation of isolation valves can be dangerous.

If in-situ installation is required, bypass mounting is preferable; make sure to install the sensor at the upper surface of the gas line to minimize its exposure to liquid water, should condensation occur, the XTR65W sensor is best suited for these applications. Also consider the need to isolate (depressurize) before installing or removing the sensor.

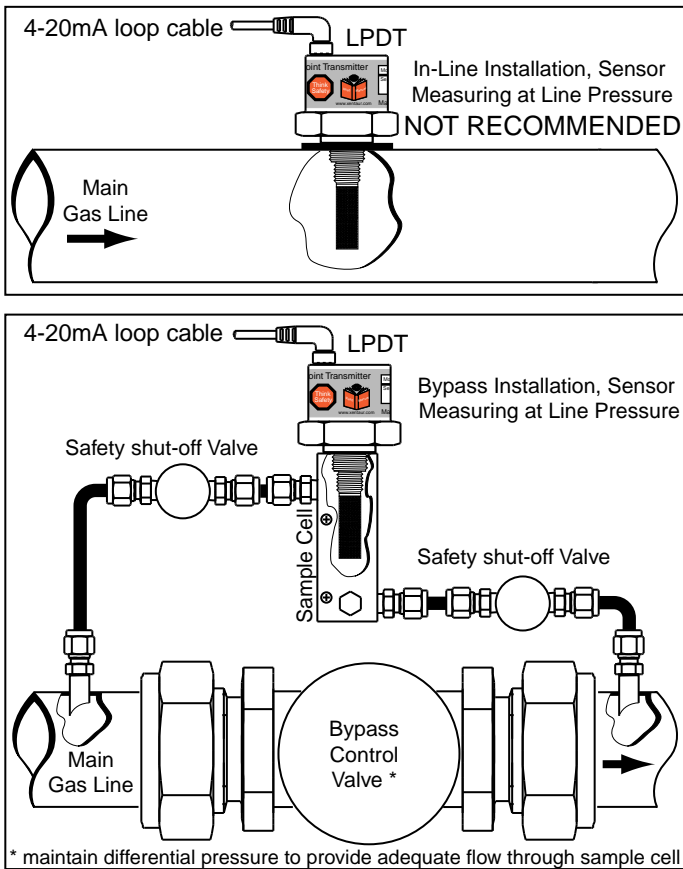

2.3.2 Extractive Installation

For extractive installations we recommend our sample system ESS, which may be equipped with a variety of features, such as: isolation valve, coalescing or particulate filter, pressure regulator, calibration sample injection or extraction port, pressure gauge, flow meter, weatherproof enclosure. Refer to the ESS literature for more information.

If the resources to make your own sample system are available, the following two diagrams may be used as a guideline to configure a simple system.

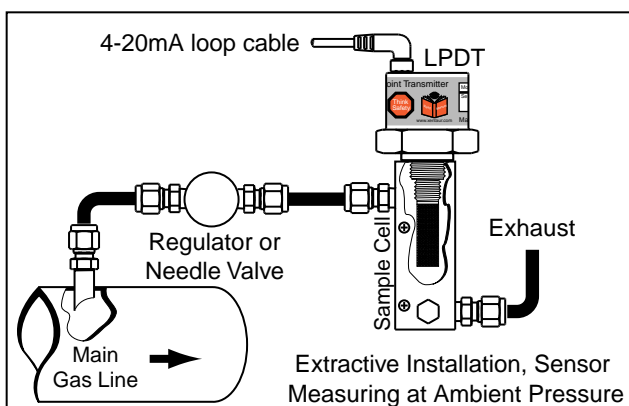
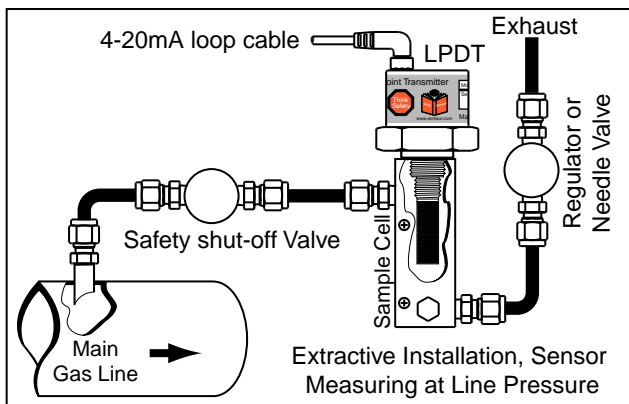

It is generally recommended to measure at ambient pressure for the following reasons:

- The readings will not be affected by variations in line pressure.
- The risk of exposing the sensor to liquid water is significantly reduced.
- ppm readings are computed for a pressure of one atmosphere (1 bar); and have to be corrected using software in the instrument, or a pressure nomograph, or calculator if the sensor is measuring at different pressures.

If readings at line pressure are necessary, it is recommended to measure at ambient pressure and to use the instrument's pressure compensation feature to calculate the dewpoint at line pressure. See appendix F.

Please make sure that:

- The sample is taken from the upper surface of the main gas line. This avoids problems with contamination. The sample should be taken away from pipe line walls where flow rates may be low, and dewpoint changes may lag.
- For dewpoints dryer than -40°F , use stainless steel tubing only. Copper tubing is acceptable for dewpoints wetter than -40°F . Do not use plastic, rubber or tygon tubing under any circumstances, as measurements would be incorrect and/or response time slow due to water retention inside these materials.
- Try to run pipes to the sensor upwards, so that contaminants tend to fall back into the main line.
- Keep the length of the sample line to the sensor as short as possible.
- Use small diameter pipes (1/4" or 1/8" OD).
- Use sufficient flow rates (e.g. 1 l/min with 6 feet of 1/8" piping is adequate). The flow rate will influence the systems' response time.

- Do not install any devices upstream of the sensor, such as other measuring systems, flow meters etc., which are not absolutely necessary as these are potential leak sources.
- Installation of a coalescing and / or particulate filter ahead of the sensor is desirable to prevent any liquid or particulate contamination of the sensor.
- If filters are used upstream of the sensor, make sure these contain non-hygroscopic filter materials only.
- If pressure regulators, shut off valves etc. are used upstream of the sensor, make sure these do not contain rubber or other hygroscopic materials.

2.4 Troubleshooting unexpected readings

If erroneous readings are suspected on a newly acquired instrument, compare the serial number engraved on the sensor sintered filter, to the one stored in the instrument memory. The two should be the same; if they are not, the instrument may not be calibrated with the installed sensor. To troubleshoot other problems, identify the unexpected reading category in the following table, and consider the possible causes and appropriate diagnostic action and remedy.







Troubleshooting unexpected readings (table spans 2 pages)

Symptom	Possible Cause
Reading is not changing	Condensation in sample system.
Slow Response	<ol style="list-style-type: none"> 1. Water vapor in the system. 2. Flow rate too low. 3. Sample pipe too large and/or too long. 4. Unsuitable sample pipe material. 5. Leaks 6. Hygroscopic materials in sample system
Dry Reading	SpanCheck™ wrongly set, or faulty sensor.
Wet Reading	Leak in system or use of unsuitable pipe.
	Comparison of readings with manual cooled-mirror instrument.
Display Shows SAt	Prolonged exposure to wet gas.
Display Shows SHr	1. Instrument Failure
	2. Short circuited sensor.
Display Shows oPn	1. Instrument failure.
	2. Open circuit on sensor.

For non-sensor related problems (e.g. no reading on instrument) refer to section 3.5

Section 2: Sensor and Sampling Techniques

Troubleshooting unexpected readings (continued from previous page)

Symptom	Diagnostic/Remedy
Reading is not changing	Condensation will occur if the temperature of the sample system, at any point is below (colder) the dewpoint temperature of the sample gas. Once having formed, the sample reaching the sensor will have a dewpoint equal to the temperature of the condensation, regardless of the dewpoint of the sample at the sample point.
Slow Response	It is usually more satisfactory to bleed a sample gas at atmospheric pressure through the sensor sampling chamber, and to use 1/8" (3mm) o.d. sample pipe. See below re: sample pipe material, also see section 2.3
Dry Reading	Verify SpanCheck™, or return sensor for full calibration to your representative.
Wet Reading	Cure the leak, or replace unsuitable pipe with copper or stainless steel. Flexible connections should be made with PTFE pipe. NEVER use rubber or plastic pipe. This type of indicator reads about 10°C dry at about -50°C dewpoint due to temperature gradients within the device. The error increases at drier levels.
Display Shows 	Dry the sensor, install sensor in either a known dry gas stream i.e. instrument quality air or dry nitrogen, or place sensor in a dry can or bottle of desiccant and seal the container from outside air (the shipping container is designed for this purpose)
Display Shows 	Remove (unscrew) sensor, if the instrument still reads  the problem is with the instrument. However, if the instrument reads  then check possible cause #2 Remove (unscrew) sensor and note that the meter reading returns to  . Use a new sensor, or apply approximately 20V DC, between the center pin & the filter body of the sensor, MOMENTARILY with the sensor in a known dry condition. Polarity is not important, but the contact MUST be very brief or the sensor may be damaged.
Display Shows 	Remove (unscrew) the sensor. Short the center contact of the LPDT sensor connection to the case, if the instrument reads  the problem is in the sensor, otherwise return the instrument for service. Check sensor connection or replace sensor.

3.1 Precautions using the LPDT

The LPDT uses state-of-the-art microelectronics to provide a miniature full functioning instrument. The user should consider the following precautions when using any sensitive electronic device.

- Do not install the unit near heat sources such as radiators or air ducts.
- Do not install the unit in places subject to extreme mechanical vibration or shock. If this is not avoidable, use resilient mounting. If in doubt, call your representative.
- Observe the appropriate electrical safety codes and regulations
- If weather proofing is required consult your representative for an optional cover.

3.1.1 Electromagnetic Compatibility Considerations

The LPDT has been designed and verified by testing to meet the requirements of the EC Council EMC Directive 89/336/EEC, for Industrial, Scientific & Medical equipment. The sensor ground (LPDT housing) is isolated from the 4-20mA loop, however they are also shunted with a 2000pF capacitor and a 33V Transient Voltage Suppressor; this prevents electrostatic buildup, noise pick-up, and in conjunction with the internal fuse protects the instrument from over-voltage inputs. Please consider the following electromagnetic interference issues during installation:

- In order to provide an acceptable noise environment for the LPDT or any other digital equipment in the proximity of inductive loads, it is recommended that there be varistors placed across the inductors to keep down the high voltage spikes during transitions.

- Any circuitry which is activated by relay contacts should account for the contact bounce, one simple debouncing method is placing a capacitor across the relay contacts.
- AC power wiring should be routed as far away from the LPDT and its wiring as practical.

3.2 Instrument Technical Specifications

Enclosure:Stainless Steel, optional weather proof cover is available.

Dimensions & Weight:.....~2"Dia. x ~4.75" long including sensor & connector (see appendix C) 0.5lbs.

Pressure operating range: ..Standard:500 PSI (34 bar).

Optional:5,000 PSI (340 bar).

Mechanical connections:... 14mm x 1.25mm threads, and 3/4"-16 threads.

Electrical connections:2.1mm x 5.5mm (12mm minimum barrel length) power jack, with retainer.

Cable:Two conductor cable, 12' (~4m) provided.

Power Requirements: 10 to 33 VDC polarity independent, the instrument draws 4-20mA depending on measured dewpoint.

Input resolution:0.1°C dewpoint.

Indicators:3.5 digit LCD with custom legends.

Engineering units: °C, °F, PPM, LBS H₂O/mm scf, gm H₂O/M³.

Controls:..... 3 push buttons, user's selections are stored in EEPROM.

Outputs:..... Analog and digital outputs are available from the LPDT.

A. 4-20mA drawn by the instrument from the power supply. The 4-20mA is linear to the selected engineering units, the range is programmable. Output resolution is 0.1°C dewpoint.

B. The instrument can supply digital output by modulating the 4-20mA loop line. The timing and format of the data conforms to RS-232, however to interface to a PC or other RS-232 device an optional adapter is required.

In the digital mode the LPDT can be remotely operated and the dewpoint as well as temperature (and pressure if installed) can be read.

In the digital mode multiple units can operate on the same loop cable as a multi-channel instrument.

Alarms:.....The 4-20mA signal or the digital output may be used by an external device to operate relays.

Isolation:Sensor and case are isolated from the current loop but are shunted with a 33V transorb and 2000pF capacitor.

3.3 Installation

3.3.1 Mechanical Installation

The LPDT has two thread sizes for mounting to the sample cavity (consult the sensor installation section) where the dewpoint will be measured. Various adapters are available for direct connection into existing system openings. Ask your representative for a Sample Cell, if you do not have the ability to provide an appropriate sample cavity mounting. If the 3/4"x16 thread is used then the LPDT will seal against the wall of the sample cell with the provided Viton A O-ring. If the 14mm x 1.25 spark plug thread is used then an additional Viton gasket must be installed to provide the proper seal. Ask your representative for this gasket, it is available free of charge. The LPDT is light enough such that either thread will mechanically support the whole instrument. To prevent any leaks, tighten the LPDT into the sample cavity, with a 1 7/8" wrench, 1/8 turn past finger-tight to assure metal-to-metal contact.

Since the tightened positioning of the LPDT is unpredictable, its front panel may be rotated (360°) to allow easy reading of the display. Press down gently on the spring loaded face plate and turn it to the desired position.

The sensor can be removed from the LPDT by unscrewing it. Make sure that the sensor is securely fastened to the LPDT (the tension washer should be compressed), so that it does not come loose during use.

3.3.2 Electrical Installation

The LPDT will operate properly with 10VDC to 33VDC at its input, if this voltage is exceeded the internal fuse may blow. When selecting the power supply voltage do not neglect the drop across any current measurement resistor and wiring in the loop. The connector is a standard 2.1mm x 5.5mm (12mm minimum barrel length) DC power jack, an internal diode bridge accommodates either polarity. The LPDT may be powered using an off-the-shelf wall transformer with 2.1mm connector, or from a power supply using the provided connectorized cable. The provided cable is terminated with a connector which has a retainer, the retainer may be used to secure the connector to the LPDT thus avoiding accidental disconnection.

The LPDT will draw 4mA to 20mA from the power supply depending on the dewpoint being measured. The dewpoints corresponding to 4mA and to 20mA are user selectable, in between the current will vary linearly to the selected engineering units, see appendix G.

Various strategies for interfacing with the LPDT are shown in Appendix D.

Please observe good electrical safety and grounding practices when connecting any electrical equipment; connecting one end (e.g. negative) of the power supply to earth ground is advisable.

After the installation is complete, proper detection by the user's equipment of the 4-20mA output, may be tested using the Analog Output test feature of the LPDT, see section

3.4.5.6.

3.4 Operating the Instrument

3.4.1 Starting up

The instrument is ready for use as soon as the power cable is installed. When power is applied the instrument will initialize its program and for a moment display $\Xi E \tau$, then it will enter the Operating State. If the MODE button is held pressed while the instrument is performing its power-up initialization, it will enter the Set-Up State, which allows the user to select operating variables of the instrument.

To accommodate a variety of installation possibilities, the LPDT front panel may be rotated (360°) by gently pressing down on the spring loaded face plate and turning it to the desired position.

3.4.2 Display Conventions

1. To display characters with the 7 segment numeric display, the following pseudo-alphanumerics are used:

Numbers:

0 123456789
 0 123456789

Letters:

ABCDEFGHIJ LNOPQRS TUXYZ
 A b C d E F G H I J L n o P q r S t U V X Y Z

Symbols:

? - .
 ? - .

2. The instrument will indicate whether a particular mode

lets you change a parameter by showing the word "SET" in the upper left corner of the display. Be careful not to change any parameter inadvertently.

3. °C°F appear simultaneously, to indicate the sensors' attenuation in decibels.
4. Values larger than ±1999 or smaller than ±0.01 are displayed in powers of $10^{\pm 3}$. As required, either a " 10^3 " or " 10^{-3} " will appear above and to the right of the displayed value, the value will be rounded off to 3½ digits. The display will show *ranG* (out of *ranGe*), if the number to be displayed is larger than 1,999,000. Twelve examples follow; for each the number and units desired to be displayed are shown in *italics*, depicted immediately below them is the resultant 3½ digit LCD display:

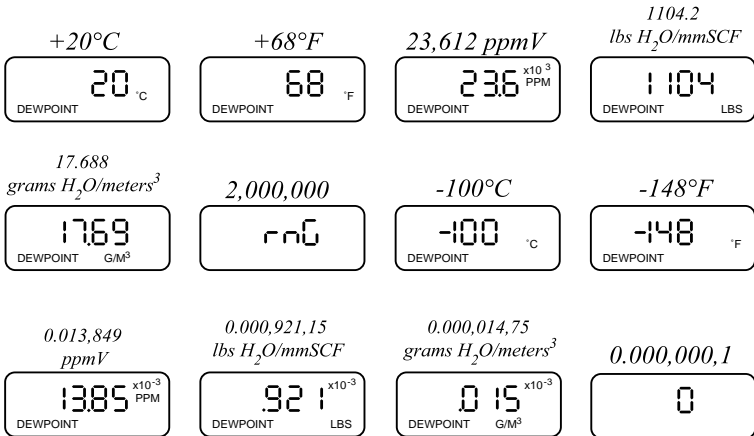

3.4.3 Push Buttons

Three push buttons are located on the front panel.

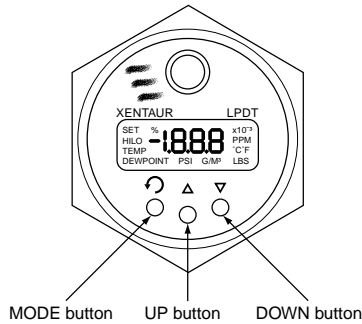

Each button is marked with an icon engraved above it. In general the MODE button navigates through the different user options “Modes”; the UP and DOWN buttons modify the units, values or choices in the selected mode. Refer to the flow diagrams in Appendix A for detailed overview of button functionality. A button may be held down for a prolonged time, for accelerated incrementing or decrementing of numeric values.

3.4.4 Operating State

Upon power up, the unit performs certain initialization tests (see table in section 3.5), and enters the ‘Operating State’, in the Viewing Dewpoint mode. Depressing the ‘MODE’ button will change modes (see appendix A) in the following order: **1** Viewing Dewpoint < **2** Viewing Temperature < **3** Start Calibration < **4** Viewing Serial Number < (back to) **1** Viewing Dewpoint. The unit will return to Viewing Dewpoint mode if no buttons are pressed for 30 seconds, unless it is performing a calibration.

3.4.4.1 Viewing Dewpoint Mode

In this mode the user can view the dewpoint, this is indicated by the presence of the 'DEWPOINT' legend on the lower left of the display. The available engineering units in which to view the moisture content are °C, °F, PPM, LBS and G/M³; the UP and DOWN buttons scroll back and forth through these units in respective order. The °C and °F are dewpoint readings. The PPM is parts per million by volume computed at the sensor pressure (more about pressure in appendix F). The LBS and G/M³ are pounds of water per million standard cubic feet and grams of water per standard cubic meters, both in Natural Gas, they are computed according to data derived by IGT Research Bulletin 8, taking into account sensor pressure.

Note that the analog output is linear to the selected engineering units, therefore be mindful that while scrolling through various units the analog output may change even though the measured dewpoint is stable.

The PSI legend flashes at the bottom of the display, when there is pressure correction in the computation of the displayed values, refer to appendix F.

3.4.4.2 Viewing Temperature at the Sensor

In this mode the user can view the thermodynamic temperature at the dewpoint sensor inside the sampling chamber, this is indicated by the flashing 'TEMP' legend on the lower left of the display. The available units in which to view the temperature are °C and °F. The UP and DOWN buttons switch back and forth between these units.

Pressing the MODE button changes to the Start Calibration Mode.

3.4.4.3 Start Calibration (SpanCheck™) Mode

The instrument is calibrated at the factory with the sensor it is shipped with and does not need to be re-calibrated prior to installation.

Instrument calibration is recommended in approximately 12 month intervals, the XTR65W sensor should be re-calibrated after prolonged exposure to liquid water. Simply follow steps 1 - 7 of the procedure below, removing the sensor from the sample gas stream. Make sure the gas stream is depressurized before removing the sensor to avoid injury. It is recommended to keep the sensor exposure to room air as short as possible to avoid super saturation of the sensor. While super saturation is not damaging to the sensor, it will prolong the initial dry-down time after you install the sensor in the sample stream. Therefore, remove the sensor from the packaging container only after you are ready to proceed with the calibration procedure and install the sensor in the sample stream immediately after the calibration procedure is completed. If you are not ready to use the sensor right away after calibration, put the sensor back in the shipping container for dry storage.

The instrument must be calibrated with the sensor it will be used with. The calibration procedure takes advantage of the designed saturation level (DSL) feature of the sensor and is executed by the instrument computer, by performing the following steps:

1. If the instrument is locked and a calibration is attempted; it will display LOL and will not perform the calibration. To unlock the instrument consult section 3.4.5.9.
2. Push the MODE key a few times until the display

- show's \overline{CAL} .
3. Press the UP button. The display will show \overline{CONF} , prompting you to confirm that you want to start the calibration procedure. You can abort the calibration procedure by pressing the MODE key.
 4. Remove the sensor from its packaging container so that the porous metal filter is visible and the sensor is exposed to in-hand micro-climate. Close the packaging container as soon as you have removed the sensor to avoid degradation of the desiccant inside of the container. You may want to re-use the container at a later date.
 5. Push the UP button again to confirm that you want to start the calibration procedure. The display will flash \overline{RC} for 60 seconds, while the sensor is saturating. Make sure you keep the sensor exposed to in-hand micro-climate until the display shows \overline{END} .
 6. After 60 seconds, the display will flash the selected sensor type (see "*Selecting a sensor type 3.4.5.2*") and then the instrument will calculate the slope and offset of the sensor curve while displaying the calculations and then will display \overline{END} for a few seconds, after which the instrument will automatically go into measuring mode. The sensor calibration is completed. (The display may flash \overline{SAT} , indicating that the sensor has super-saturated. As soon as the sensor is exposed to an atmosphere with a dewpoint lower than the saturation dewpoint, the display will indicate the dewpoint measured by the sensor.) The display may show alternating \overline{SE} and \overline{LO} as an indication that the measured capacitance is too low to be from a saturated sensor, in this case make sure that the sensor is fully engaged into the LPDT, and repeat the calibration procedure.

7. Install the sensor in the sample cell or adapter fitting or put it back into the packaging container for later use.

The instrument will retain the calibration even if the power is turned off.

Under certain conditions, an over (super) saturated sensor may need to be completely dried out before a calibration is performed. Symptoms of these conditions are a sensor that will not go through the SpanCheck™ function to the ETD display, or a sensor that will not dry down after calibration. To dry, install sensor in either a known dry gas stream i.e. instrument quality air or dry nitrogen, or place sensor in a dry can or bottle of desiccant and seal the container from outside air (the shipping container is designed for this purpose). After a minimum dry out period of 24 hours, proceed with the calibration procedure of your choice.

SpanCheck™ calibrates sensors by using micro climates. Please contact your representative if you have any questions about how to create such micro climates.

A perfectly acceptable and accurate for calibration micro-climate may be created for the XTR100 and XTR65 sensors by cupping the sensor in the palm of one's hand during the SpanCheck™ procedure. Remember that the micro-climate does not have to be accurate, it just has to be higher than the designed saturation level. The dewpoint of the micro-climate within the fingers is usually higher than the dewpoint of the room air and probably well above the +20°C upper range of the sensor. On a dry day one may need to exhale in the hand before cupping the sensor to guarantee a high dewpoint. The sensor should be warmed up close to body temperature before performing this procedure. Care must be taken that the sensor temperature is not below the tempera-

ture of the hand, as in such case condensation could occur and super saturate the sensor. For the same reason, avoid exhaling directly onto the sensor.

3.4.4.4 Viewing Serial Number Mode

In this mode the user can view the serial number of the sensor calibrated and shipped with the instrument. This number is also engraved on the stainless steel sintered filter of the sensor element. The display shows the serial number by alternately displaying $\Xi 5n$ and the number. If the number is larger than 1999 then it is displayed in 2 parts, first part is the thousands signified by the $\times 10^3$ legend in the upper right corner of the display and the second part is the units. For example serial number 12345 will be shown as:

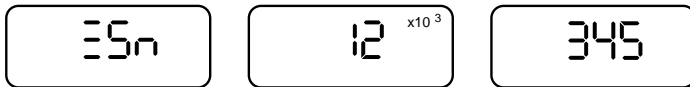

Pressing the UP and DOWN buttons simultaneously resets the instrument, this is useful for restarting in the set-up state (by holding the MODE button), in installations where power can not be turned on and off easily.

Pressing the MODE button changes the unit to the Viewing Dewpoint Mode.

3.4.5 SetUp State

To enter the Setup State power-up the unit (or reset it from the serial number Mode), and hold the MODE key pressed while the unit is initializing. Refer to Appendix B for a flow diagram of the SetUp State.

The setup state provides nine capabilities, each one controlled from its own mode. Depressing the MODE button navigates through the modes in the following order: ❶ Select Alternate Display Units < ❷ Select Sensor Type < ❸ Set Measured Attenuation of Sensor at a Low Dewpoint < ❹ Set the Low Dewpoint at which the Attenuation was measured < ❺ Set the Calibration Mid-range Adjust < ❻ Perform a Test and Verification of the Analog Output < ❼ Set dewpoint corresponding to 4mA of Analog Output < ❽ Set dewpoint corresponding to 20mA of Analog Output < ❾ Lock/Unlock the instrument < (back to) ❶ Select Alternate Display Units. These nine functions are explained in their respective sections which follow. Changes can be made only to an unlocked instrument, the changes are stored (when the MODE button is pressed) and retained even if the unit is turned off.

1. **Display of alternate units:** In this mode, a second engineering unit can be chosen to be displayed alternating with the engineering unit selected in the operating state, for example, a dewpoint can be displayed alternating with the sample temperature, or dewpoint can be alternately shown in °C and in PPM.
2. **Selecting the sensor type:** In this mode the user can select the software matching the type of sensor installed in the instrument;
 - ☰☲☱ : XTR-100 (-100°C to +20°C);
 - ☰☲☳ : XTR-65 (-65°C to +20°C).

3&4 Adjusting low end sensor attenuation and dewpoint:

These modes are used to enter a data pair representing a low dewpoint and the sensor attenuation measured at this low dewpoint. (see Sensor Theory of Operation appendix E). This data pair should not be modified unless the sensor is replaced. The sensor shipping container is labeled with the proper values.

5. **Calibration Adjustment:** In this mode the user can enter a sensor specific Adjustment Value to improve the instruments' accuracy in the range of -50°C to -10°C , this adjustment has very little or no effect outside this range. The Calibration Adjustment Value is printed on the shipping container supplied with the sensor, or may be derived if the sensor can be exposed to a known reference.

A) Deriving an Adjustment Value: If the adjustment value for your sensor is not known, contact your representative and follow the instructions in paragraph B on the next page. If the value is not available, then it may be derived using a manual method, provided that a moisture calibration lab is available.

The calibration must be done in the range of -25°C to -20°C (attempting to calibrate outside this range may cause inaccuracies), the dewpoint must be kept stable during calibration and it must be measured accurately by a reference instrument such as a chilled mirror. One must also note the state of pressure compensation and turn it on or off as applicable to the reference.

The necessary steps are described below (also refer to the Set-Up State flow diagram in Appendix B):

- a. Make sure that the low attenuation and low dewpoint are correctly entered for this sensor.
- b. SpanCheck™ the sensor.
- c. Dry-down the sensor for at least 12 hrs.
- d. Expose the sensor to the known dewpoint (-25°C to -20°C), for a sufficient time (at least 30 min.)
- e. Go to the $\llbracket \text{RL/Rd} \rrbracket$ mode and press the UP button, the display will show the current value, in the range of -1.99 to $+1.99$ followed by blinking horizontal lines.
- f. Observe the display, if the buttons are not being

pressed; the display will every few seconds show for a short duration the dewpoint as being computed at the moment (utilizing the current cal-adjust value in the computation).

g. Use the UP or DOWN buttons to modify the cal-adjust value and observe the alternately displayed dewpoint. Perform this adjustment until the dewpoint matches the value shown by the reference instrument.

h. Press the MODE button to go to the next mode, this will save the new cal-adjust value, and it will be retained even if power is turned off.

B) Entering a known Adjustment Value: If the sensor is being replaced an adjustment value should be supplied with the sensor, to enter it into the instrument:

a. Go to the $\left[\text{CAL/Adj} \right]$ mode and press the UP button, the display will show the current value, in the range of -1.99 to +1.99 followed by blinking horizontal lines, ignore the alternately displayed dewpoint.

b. Use the UP or DOWN buttons to modify the cal-adjust value as necessary.

c. Press the MODE button to go to the next mode, this will save the new cal-adjust value, and it will be retained even if power is turned off.

2), 3), 4) and 5) are set at the factory and need only be modified when a sensor is changed.

6. **Testing the analog output:** By pushing the UP or DOWN buttons, the user forces the analog output to its low and high values, respectively. This facilitates the hook-up and testing of the user's monitoring equipment.

7&8 Output range setting: These modes are used to set dewpoints corresponding to the low and/or high end of the current loop output, refer to appendix G.

9. **Lock/Unlock the instrument:** This mode is used to block access to parameter settings, protecting the instrument from unauthorized or inadvertent changes of parameters. Attempting to change settings while instrument is locked will display $L\alpha\Gamma$.

To unlock the instrument press the UP button, to lock the instrument press the DOWN button. Pressing the MODE button will navigate back to the Select Alternate Display Units mode.

Pressing and holding either the UP or DOWN button, will save the lock or unlock setting depending on the button, and reset the instrument. This feature is useful if it is difficult to power off the instrument.

Note: It is imperative that one returns the instrument to the locked mode to avoid unauthorized changes.

3.5 Troubleshooting the Instrument

This instrument performs diagnostic tests on power up as well as once every two minutes. The table that follows, depicts all possible error/unexpected messages that may be displayed on the instrument. For each message the table has explanations for the reason, and if necessary a suggested action to remedy it.

Section 3: Instrument

DISPLAY	EXPLANATION		REQUIRED ACTION
LO Err	PROM check sum failed.	power on tests	cycle power if problem persists, return to your representative for service.
HI Err	RAM write/read test failed.		
% Err	Unidentified power-up failure.		
CSF/	EEPROM Check Sum Failed.		
Err/Ad	A/D converter failure.	system tests once per 2 min.	check input voltage 10-33VDC make sure that the unit is at a temperature of -10°C to +70°C.
Err/rEF	Reference voltage for A/D out of spec.		
Lo/bAt	Low supply voltage.		
LO r n C / TEMP	Instrument <i>low temperature range</i> has been exceeded.		
HI r n C / TEMP	Instrument <i>high temperature range</i> has been exceeded.	dewpoint display tests	see table in sensor troubleshooting section select sensor and SpanCheck.
oPn/	Sensor circuit is <i>open</i> .		
SAt/	Sensor is <i>saturated</i> .		
SHr/	Sensor circuit is <i>shorted</i> .		
...	Trying to calculate dewpoint for undefined sensor.	Calibration tests	see Calibration instructions.
db	Trying to calibrate an undefined sensor.		
SEn/2Lo	Sensor reading is ' <i>too low</i> ' to be a satu- rated sensor, for SpanCheck.		
Err/EEP	EEPROM write cycle not completed.	miscellaneous	if this persists, return for service.
LoC	Attempting to modify a <i>locked</i> unit.		unlock unit, see set-up mode.
r n C	number can not be displayed in 3.5 digits.		
- 70°C(-94°F) w/flashing DEWPOINT	An XTR-65 sensor is measuring less than -70°C or -94°F dewpoint.		
PSI flashing when dew	Pressure correction is enabled.		
ΞEn	Turn on message, <i>Xen</i> taur (<i>Greek Ξ=X</i>)		

Legend: /denotes alternately flashing messages.

The instrument contains a fuse which may open if the instrument is subjected to voltages exceeding the specifications. Under these circumstances the unit display will be blank and the instrument will not draw any current when powered up. The fuse is not user replaceable, therefore the LPDT must be sent to your representative for servicing.

Appendix A: Operating State User Interface flowchart

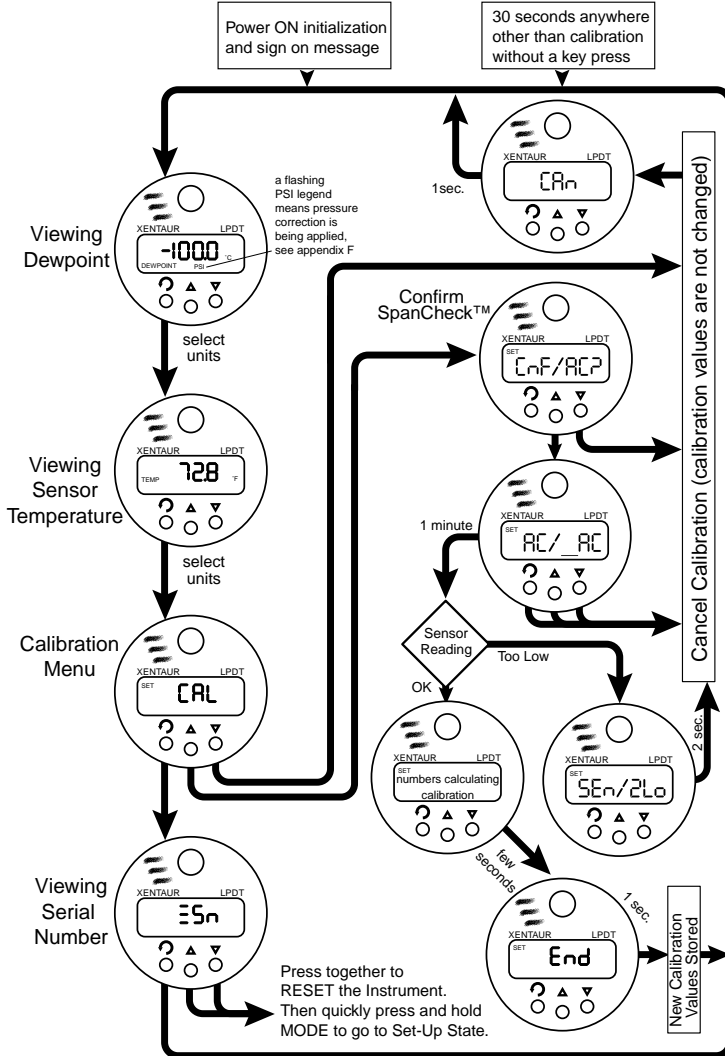

- LEGEND:
1. Arrows leading out from below a button depict the flow as a result of pressing the button.
 2. Arrows leading out of other locations depict flow as a result of completing a function or a time-out.
 3. A slash '/' in the display area, is used to depict two alternately shown (flashing back and forth) messages.

Appendix B: Set-Up State User Interface flowchart

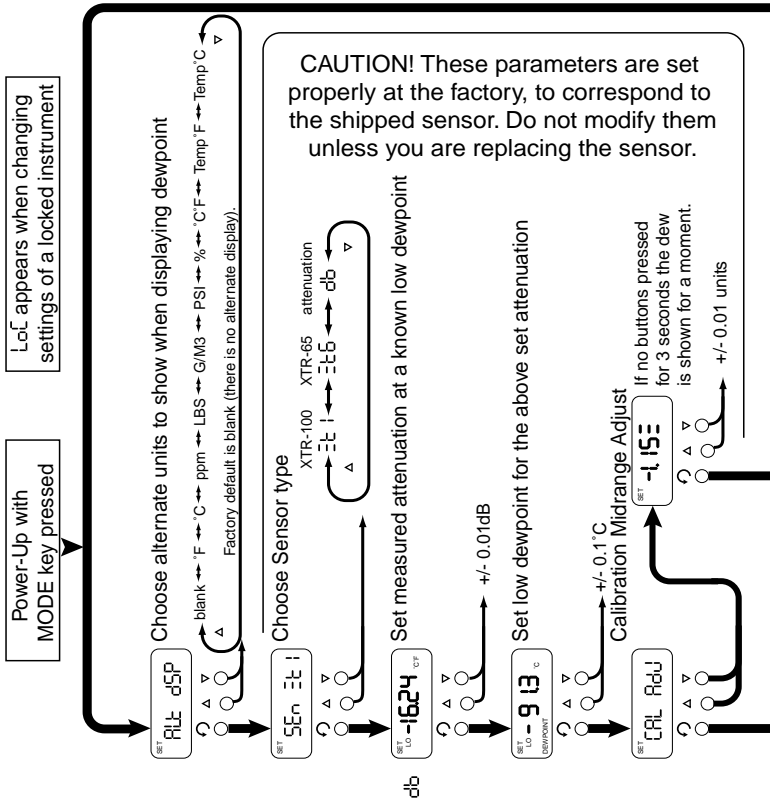

User Interface Flow Diagram - Set-Up State (continued from previous page)

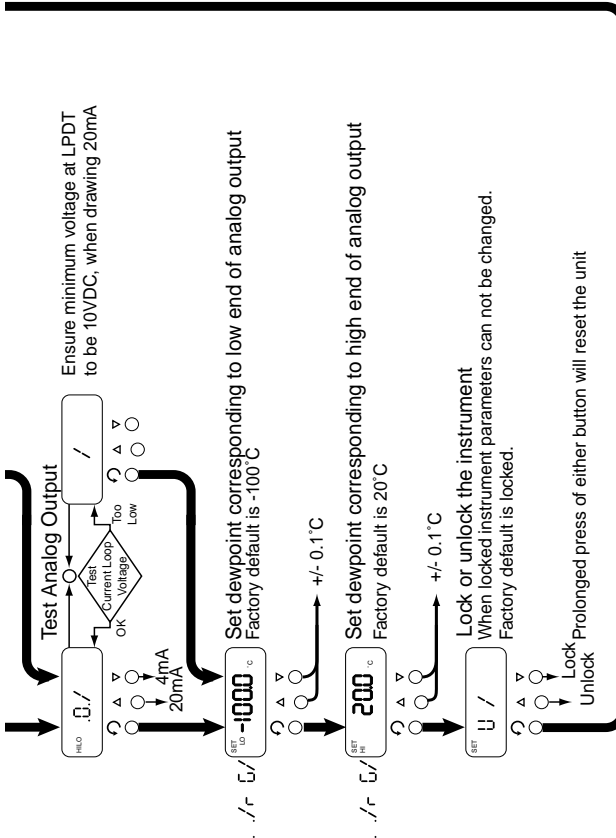

- LEGEND:**
1. Arrows leading out from below a button depict the flow as a result of pressing the button.
 2. A slash '/' in the display area, is used to depict two alternately shown (flashing back and forth) messages.

Appendix C: LPDT Mechanical Drawing

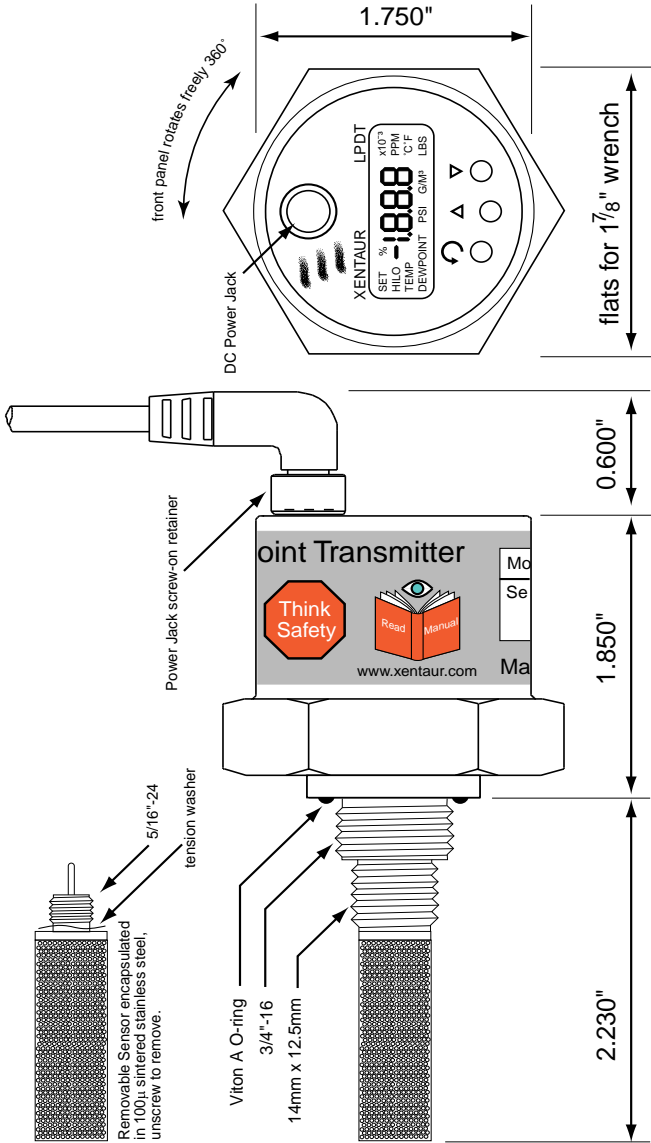

Appendix D: LPDT Electrical Connections

Methods of Using and Interfacing the LPDT

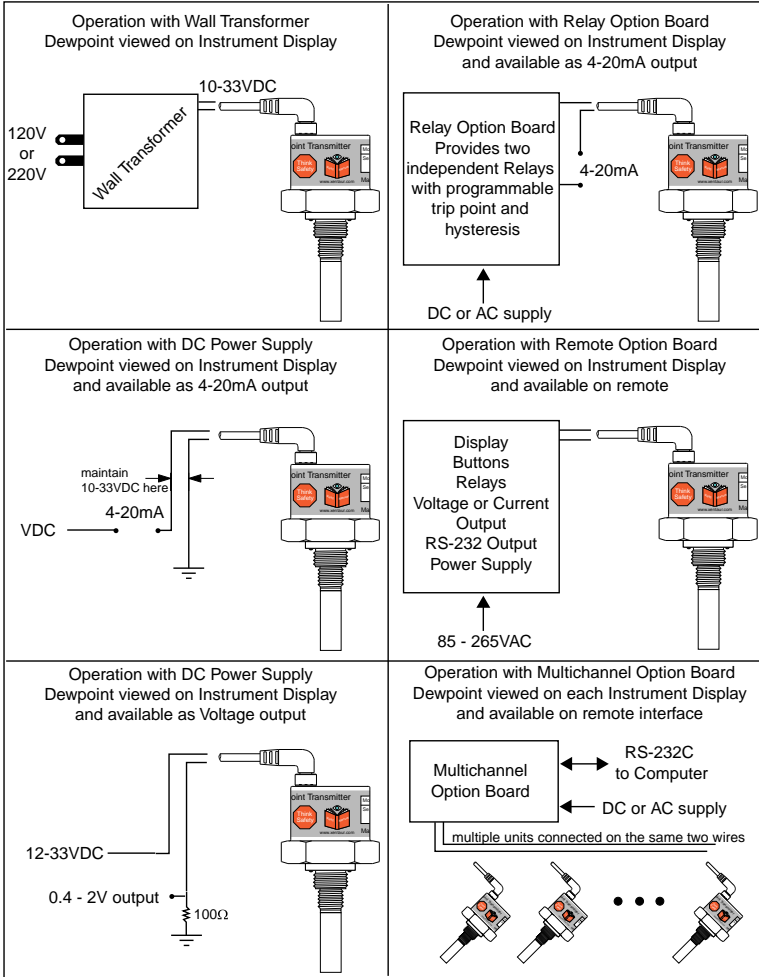

Appendix E: Sensor/SpanCheck™ Theory of Operation

The Sensor is constructed as a capacitor whose dielectric consists of porous Aluminum Oxide as well as the gas that has entered in the pores of the Aluminum Oxide. The plates (electrodes) of this capacitor are an aluminum substrate and a porous gold layer deposited on top of the Aluminum Oxide, the porous gold electrode allows transfer of gasses into or out of the Aluminum Oxide pores.

The capacitance due to the Aluminum Oxide is always constant, while the capacitance due to the gas varies according to the gas content and pressure. Since the dielectric constant of water is orders of magnitude larger than that of any gases being measured, the quantity of water vapor present in the pores changes the capacitance of the sensor to a much greater extent than any other system variable. For the same reason (the extremely large dielectric constant of the water molecule), any capacitance variations arising from the Aluminum Oxide, such as changes due to temperature are insignificant in relation to the capacitance due to the water content. Thus the sensor capacitance varies greatly in proportion to the water content in the surrounding gas. The sensor is designed such that the relationship of the quantity of water and the resultant capacitance has an "S" shaped curve. At the extremely dry end the curve is asymptotic to the capacitance due to the Aluminum Oxide and the gas, while at the very wet end the curve is asymptotic to the capacitance due to water molecules packed extremely tightly (saturated) in the pores of the Aluminum Oxide. This upper end is an excellent indication of the total pore volume; while the lower end of the curve is an indication of the distance between, and area of the capacitor plates (electrodes), this is the intrinsic capacitance of the sensor. Therefore knowing these two points, a sensor can be calibrated with compensa-

tion for small manufacturing deviations.

As the sensor is used in real world applications, it is exposed to various elements and stress; like any other sensor it may over time drift from calibration. However one must note that the intrinsic capacitance will not change with use because it is based simply on the dielectric constant of Al_2O_3 and the distance between, & area of the plates (electrodes), thus the original factory measured values will always be valid. What may change is the pore volume, due to clogging with contaminants, residual oxidation, metal migration, etc. Thus to re-calibrate the sensor the instrument needs only to "know" the capacitance at the wet end of the curve. As discussed previously the capacitance at the wet end approaches asymptotically a saturated pore capacitance, therefore if the sensor is saturated (the exact water content will not be important since the curve is asymptotic), then the instrument can measure the capacitance and re-calibrate the sensor. This is referred to as SpanCheck™. The advantages of this unique capability of Xentaur sensors and instruments are obvious in time and cost savings for re-calibration, as well as ease of sensor replacement.

Xentaur HTF™ Sensor: Dewpoint vs. Capacitance Response Curve

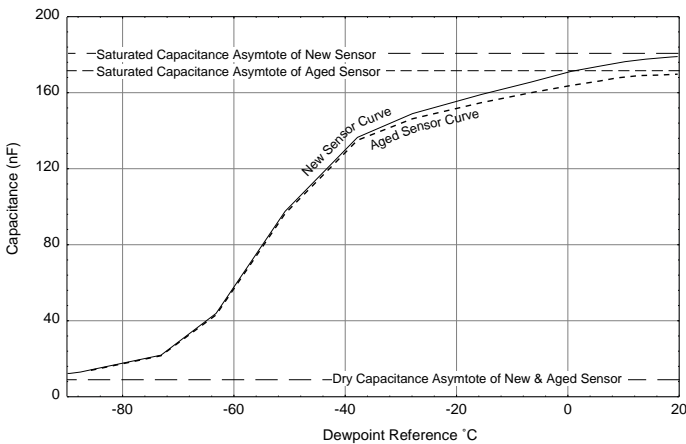

Appendix F: Pressure Correction

Sensor pressure is used in the context that this is the pressure inside the sampling chamber when performing the measurement.

Gas pressure is used in the context that this is the pressure to be used in computing what the dewpoint would be at a pressure different than the one in the sampling chamber.

Pressure correction is used in the context that the values displayed signify the moisture content at some pressure (we refer to this as the 'Gas Pressure') different than the pressure at the sensor. Note that PPM, LBS and G/M³ readings are by definition unaffected by pressure correction because only the pressure at the sensor affects their value. While °C and °F are affected by pressure correction by reporting what the dewpoint would be at the Gas Pressure when the dewpoint is what is measured at the pressure at the sensor. However, this also implies that whether pressure correction is applied or not the PPM, LBS and G/M³ readings are affected by the setting of the sensor pressure.

The factory default settings are: 14.7psi for both sensor and gas pressure and pressure correction disabled.

When Pressure correction is disabled all dewpoints are computed by assuming that both Sensor and Gas Pressures are 14.7psi.

As all Xentaur dewpoint meters, the LPDT is equipped with the necessary software to perform pressure correction.

However, for the lack of space, the LPDT does not have a Pressure Correct button. Therefore the user can not set or enable Pressure Correction, this must be done at the factory. Consult with your representative.

Appendix G: Current vs. Dewpoint

The current being pulled by the LPDT, varies with the dewpoint being measured by the LPDT. To use the current to calculate the value of the dewpoint measurement, one must know the settings of the low and high ends of the analog output range, then:

$$D = \frac{(I - 4) \times (H - L)}{16} + L$$

where: I = current drawn by LPDT loop in mA.
 H = value of High end of Analog Output range converted to selected engineering units
 L = value of Low end of Analog Output range converted to selected engineering units
 D = dewpoint measured by instrument in selected engineering units.

Consult section 3.4.5.7&8 and/or appendix B, to check and set the Analog Output low and high ranges; the factory default settings are -100°C and +20°C respectively. For example a unit with factory default settings, drawing 12mA is computed to be measuring a dewpoint of -40°C:

$$\frac{(12 - 4) \times (20 - (-100))}{16} + (-100) = -40$$

Note that the computation is such that the current is linear to the selected engineering units. Hence, selecting ppmV or LBS or G/M3 units, will cause the analog output to be linearly proportional to those units (approximately logarithmically proportional to dewpoint), refer to the graph that follows. Naturally selecting °C or °F will cause the analog output to be linearly proportional to dewpoint.

When monitoring in ppmV or LBS or G/M3, the analog output low & high ranges may have to be adjusted to pro-

vide a useful output. Consider an example where the area of interest to be monitored is 10 to 100 ppmV, and the analog output is set up with the factory defaults of -100°C to $+20^{\circ}\text{C}$ (which is 0.014 to 23612 ppmV); then the current loop output will vary only from ~ 4.1 to ~ 4.2 mA in the area of interest (consult with the graph on the following page). In most instances this would be an unacceptable output for proper monitoring of the measurement. In this example the user should adjust the analog output low & high ranges such that the output range is better suited to the measurement of 10 to 100 ppmV. It may be useful to select the low and high ranges to be 5 and 150 ppmV respectively, thus out of range conditions will be detected properly. Then the low range will be set to 5ppmV which is -65.5°C dewpoint, and the high range will be set to 150ppmV which is -38.5°C dewpoint. Now the current loop output will be 4.55 to 14.48 mA in the range of 10 to 100 ppmV, the $\sim 10\text{mA}$ variation is more than sufficient for a good measurement by the user's equipment. One may carry out similar calculations for LBS or G/M3 and choose the appropriate settings. While making these computations it may be useful to obtain a copy of Xentaur's dewpoint calculator, this is a Microsoft Windows™ program which simplifies the process of converting dewpoint measurement units. It is available at www.xentaur.com. If you are not certain how to carry out such calculations send, by e-mail to xentaur@xentaur.com or by fax to (516) 345-5349, your system specifics, and someone will get back to you with appropriate analog output settings.

In general, if the dewpoint is monitored in $^{\circ}\text{C}$ or $^{\circ}\text{F}$, there is no need to change the factory default -100°C to $+20^{\circ}\text{C}$ settings, because the 4-20mA provides sufficient resolution to measure the output better than the specified accuracy of the sensor.

Relationship of 4-20mA output and instrument reading in ppmV or LBS

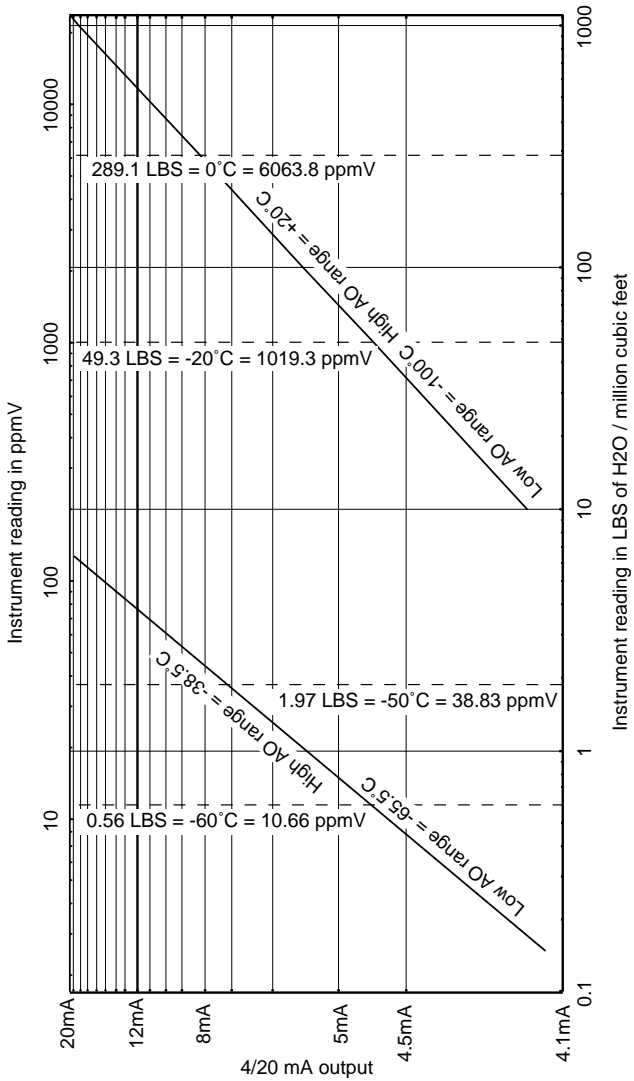

Appendix H: Uncertainty in LBS & ppmV calculations

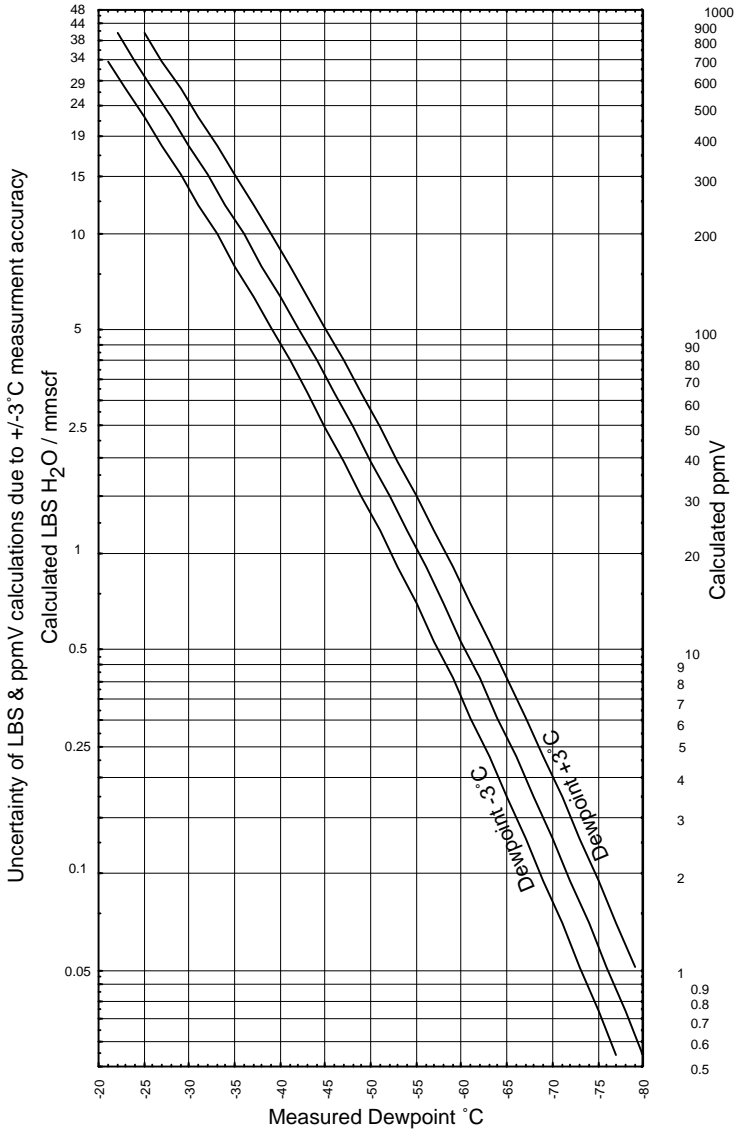

Appendix I: Sensor Response Time

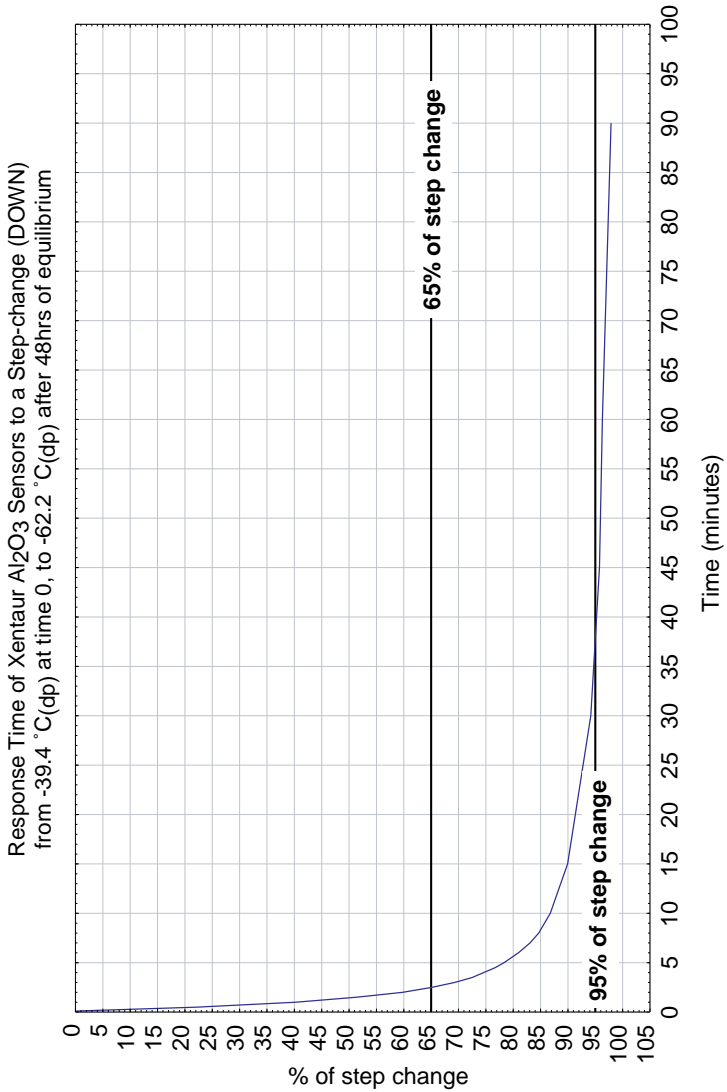

Return Authorization Request

Xentaur must approve and assign a return authorization number (RAN) to any instrument being returned. The RAN must appear on all paperwork and packaging. The issuance of a RAN does not automatically imply that the instrument is covered by our warranty.

In order to serve you better and protect our employees from any potentially hazardous contaminants Xentaur must return unopened at the senders expense all items that do not have a RAN.

To obtain a RAN fill out a copy of this form and fax to (516) 345-5349.

Customer Information

Company Name: _____ Address: _____

Contact Name: _____

Phone: _____

Fax: _____

Equipment Information

Part or model number: **LPDT** Serial number: _____

Original Purchase date: _____ P.O. number: _____

Reason for return, failure and hookup description if applicable:

Process material(s) and/or environments (including radiation) to which the equipment has been exposed:

OSHA Hazard Communication Standard 29CFR 1910.1200 mandated that we take specific steps to protect our employees from exposure to potential hazards. Therefore, a letter certifying that the equipment has been decontaminated must accompany all equipment exposed to hazardous contamination.



Xentaur Corporation, 3661 Horseblock Road, Medford, NY 11763 USA Tel: (516) 345-3434