

## UDC3500 Universal Digital Controller

## Specification

### Overview

#### New Power and Flexibility

The UDC3500 Universal Digital Controller packs new powerful features in the popular 1/4 DIN size.

Unmatched application power includes: Infrared (IR) Configuration interface, three universal analog inputs, two loops of control and two Math Algorithms. When these are combined with the Accutune III™ tuning with fuzzy logic overshoot suppression, the result is price/performance leadership.

Application flexibility is assured by the universal analog inputs, universal AC power supply, four digital inputs, a maximum of seven analog and digital outputs, Infrared, RS422/485 Modbus RTU or Ethernet 10Base-T TCP/IP Modbus communication protocols, simple configuration plus total field upgrade capability for any optional feature.

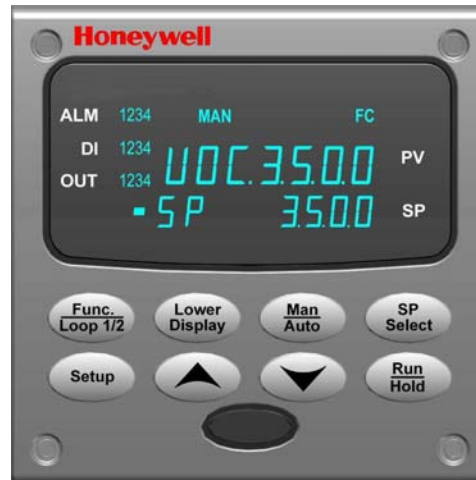

Figure 1 - UDC3500 Universal Digital Controller

### Features

- 3 Universal Analog Inputs (can be configured to operate as 1 Universal and 4 High Level Inputs)
- 0.10% Accuracy
- Fast scanning rate (166ms)
- Up to 3 Analog Outputs
- Up to 5 Digital Outputs
- 4 Digital Inputs
- Math Functions
- Ethernet or RS-485 communication
- Cascade or 2 Loops of control
- Infrared PC & Pocket PC configuration
- Healthwatch Maintenance Tool
- NEMA4X and IP66 front face protection
- Multilanguage prompts
- ¼ DIN Size
- Easily Field Upgradeable
- Bright, dual displays with multi-language prompts (in English, French, German, Spanish, or Italian) make the operator interface easy to read, understand, and operate. Simple keystrokes let you set operating parameters that meet your process control needs.

### Analog Inputs

The UDC3500 has up to three Universal analog inputs with a typical accuracy of  $\pm 0.10\%$  of full-scale input and a typical resolution of 16 bits. These can easily be configured to operate as 2 Universal and 2 High Level or as 1 Universal and 4 High Level inputs. All analog inputs are sampled six times per second (every 166 milliseconds). The first, or Process Variable input, can be one of various thermocouple, RTD, Radiamatic or linear actuators as shown in Table 1. Linear actuators have thermocouple, RTD and Radiamatic transmitter characterization capability as a standard feature. Linear actuators also have square root capability.

The optional second and third inputs are isolated from each other and all other circuits and accept the same actuators as input one. These optional inputs can each be split into two high level inputs. The fourth input is enabled by first configuring Input 2 as a 20 mA or 5 Vdc input type (High Level Analog Input – HLAI). Input 4 is then available as a high level input. The fifth input is enabled by first configuring Input 3 as a 20 mA or 5 Vdc type (HLAI). Input 5 is then available as a high level input.

### Analog Inputs (continued)

All actuators and characterizations are keyboard configurable. A separate Cold Junction compensator is provided for each thermocouple type analog input, thus maximizing accuracy. Upscale, downscale or failsafe sensor break protection is keyboard configurable. Square Root Extraction, Ratio/Bias and a configurable digital filter of 0 to 120 seconds for signal damping are available for each input. See Table 1 for other details.

### Math Functions (Option)

**Algorithms** – Two pre-configured algorithms are available for easy implementation. The following selections are available:

*Feedforward Summer*—Uses any input, followed by a Ratio/Bias calculation, summed directly with the computed PID output value to provide a resultant output to the final control element (**standard feature**).

*Feedforward Multiplier*—Uses any input, multiplied by the calculated PID output to provide a resultant output, which is sent to the final control element (**standard feature**).

**Math Functions (Option)—continued**

**Weighted Average** – Averages any two inputs to derive the PV or SP (**standard feature**).

**Summer/Subtractor** – Will add or subtract up to three inputs with the result used as the derived PV or SP.

**Multiplier/Divider** – Uses the analog inputs to calculate a derived PV or SP. Available with or without Square Root.

**Input High/Low Select** – Specifies the PV or SP as the higher or lower of the two inputs.

**8 Segment Characterizers** – Two 8-segment characterizers are available that can be applied to any Analog Input, to Loop 1 Output or to Loop 2 Output. These can be linked together to produce a single 16-segment characterizer.

**Polynomial Curve Characterizer** – A fifth order polynomial equation can be used on any one of the analog inputs.

**Totalizer** – Calculates and displays the total flow volume as measured by one of the analog inputs or as derived by either Math algorithm. Displayed value is eight digits with a configurable scaling factor. The totalizer value may be reset.

**Combinational Inputs** – Inputs can be combined for use with Relative Humidity, % Oxygen, Carbon Potential, Dewpoint or Math Algorithms. This controller can accept carbon probes from Cambridge, Marathon Monitors, Corning, A.A.A.C, Barber Coleman, MacDhui, Bricesco or Furnace Controls. See Table 1 for other details.

**Logic Gates** – Five Logic Gates configurable as OR, NOR, AND, NAND, XOR, XNOR, or COMPARATOR. Each Gate has two inputs and one output. Logic Gates may be linked together to perform more complex functions.

**Communications**

An infrared communication link is standard on the UDC3500, which allows a non-intrusive configuration of the instrument via Honeywell Process Instrument Explorer (P.I.E.) software.

RS-422/485 Modbus® RTU or Ethernet TCP/IP Modbus communications links are available as options. These allow communications between the UDC3500 and a host computer or PLC. The Second Current Output option is mutually exclusive with the Ethernet Communications option.

**Outputs and Control**

**Output Types** – The UDC3500 may have as many as seven analog and digital outputs made up of two or more of the following types:

- Current Outputs (4-20 or 0-20 mA)
- Electromechanical Relays (5 amps)
- Solid State Relay (1 amp)
- Dual Electromechanical Relays (2 amps)
- Open Collector Output (20 mA)

**Output Algorithms** – The UDC3500 is available with one or more of the following output algorithms:

- **Time Proportional** provides On-Off or Time Proportional (Relay) output.
- **Current Proportional** supplies proportional direct current output for those final control elements that require a 4-20mA signal. Output can be easily configured via the keyboard for 0-20mA operation without recalibration.
- **Position Proportional** positions a reversible motor with a feedback slidewire in proportion to the output of the control algorithm. Requires the Dual Relay Output option and the Third Analog Input. Not available on Loop 2.
- **Current Proportional Duplex** – Similar to current proportional but provides a second set of tuning parameters and a split range current output or a second current output via one of the optional current outputs, for the heat and cool zones.
- **Time Proportional Duplex** – Depending on which control algorithm you select, this duplex output algorithm can provide On-Off Duplex, Time Proportional Duplex, or Three Position Step Control (TPSC). The Time Proportional Duplex output algorithm provides two independent PID tuning sets and two time proportional outputs; one for heat zone above 50% output, and one for cool zone below 50% output. Requires the Dual Relay Output option.

- **Current/Relay Duplex (Relay=Heat)** – A variation of Duplex with Current active for 0 to 50% output and Relay active 50 to 100% output.

**Outputs and Control (continued)**

**Output Algorithms, continued**

- **Relay/Current Duplex (Relay=Cool)** – A variation of Duplex with Current active for 50 to 100% output and Relay active for 0 to 50% output.

**Control Algorithms** – Depending on the output algorithms specified, the controller can be configured for the following control algorithms:

- On-Off
- PID-A
- PID-B
- PD with Manual Reset
- Three Position Step Control (TPSC)

The TPSC algorithm is a form of motor control that does not require a feedback slidewire linked to the motor shaft. Similar to Position Proportional control, TPSC uses two relays to control an electric motor; one to drive the motor upscale and the other to drive the motor downscale. TPSC is an automatic back-up mode to Position Proportional Control if the feedback slidewire signal should fail. TPSC requires the Dual Relay Output Option. TPSC is not available on Loop 2.

**Dual Loop – Internal Cascade (Optional)** – Two independent loops or internally cascaded loops in one device. Includes Output Override Algorithm.

**Five Control Modes** – The following control modes are available:

1. Manual (one or two loops)
2. Automatic with Local Setpoint (one or two loops)
3. Automatic with Remote Setpoint (one or two loops)
4. Manual Cascade
5. Automatic Cascade

**Digital Inputs (Option)**

Four isolated digital inputs are provided for remote dry contact closure to select one of the following actions:

- Manual control mode
- Local Setpoint 1
- Local Setpoint 2
- Local Setpoint 3
- Local Setpoint 4
- Remote Setpoint
- Direct controller action
- Hold SP Ramp/Program
- Run - SP Ramp/Program
- ReRun - SP Ramp/Program
- External program reset
- Select PID set 2
- Select PID set 3
- Select PID set 4
- Disable PID integral action
- PV = Input 2
- PV = Input 3
- Manual mode, failsafe output
- Disable keyboard
- Output 1 = Fixed value
- Start Timer
- Auto/Manual Station
- Initiate Tuning
- Initiate PV Hot Start
- Output 1 tracks Input 2
- PID reset feedback via Input 2
- Purge
- Auxiliary Output Purge
- Low Fire
- To Latching Manual Mode
- Reset Totalizer
- PV Hold

Digital inputs 1 and 2 can have one of the following selections combined with one of the above selections:

- Select PID set 2
- Direct controller action
- Local Setpoint 1
- Local Setpoint 2
- Disable Accutune
- To Run – SP Ramp/Program

Any unused current output connected to a remote dry contact can be used to trip an alarm relay, thus acting as an additional digital input.

**Miscellaneous Features**

**Auxiliary Output** – Any of the three current outputs can function as an Auxiliary Output, which can be scaled for 0 to 100% for any range. An Auxiliary Output can be configured to represent any analog input, PV, active Setpoint, Local SP1, Remote SP, Deviation, or Control Output. The Second Current Output option is mutually exclusive with the Ethernet Communications option.

**Miscellaneous Features (continued)**

**Transmitter Power** – This option provides up to 30 volts dc to power a 2-wire transmitter (requires the use of Output #2 open collector output selection or one of the current outputs).

**Four Local and one Remote Setpoints** – Each loop can be configured to provide four Local Setpoints and one Remote Setpoint, which can be automatically or manually selectable either via the keyboard or by Digital Input.

**Universal Switching Power** – Operates on any line voltage from 90 to 264 Vac 50/60 Hz without jumpers. 24 Vac/dc instrument power is available as an option.

**Four Sets of Tuning Constants** – Four sets of PID parameters can be configured for each loop and can be selected automatically or manually by Keyboard or Digital Input.

**Timer** – This standard feature provides a configurable time period of 0 to 99 hours, 59 minutes or units of minutes and seconds. It can be started via the keyboard, Alarm 2, the Real Time Clock or by a digital input. The timer output is Alarm 1, which energizes at the end of the Timer Period. Alarm 1 can be automatically reset. The Timer Period can be changed between each batch. Status is shown on the lower display.

**Moisture Protection** – The NEMA4X and IP66 rated front face permits use in applications where it may be subjected to moisture, dust, or hose-down conditions. UL and CSA approved as Type 4 protection.

**Setpoint Ramp/Soak Programming (Optional)** – Enables you to program and store up to ten Ramp and ten Soak segments (20 total) for Setpoint Programming (SPP). Run or Hold of program is keyboard or remote digital switch selectable. Each Soak Segment may have a unique Guaranteed Soak Deviation value. Each Ramp and Soak Segment can be configured to use any one of the four PID Sets.

**Enhanced Setpoint Ramp/Soak Programming (Optional)** – Enables you to program and store up to four independent Setpoint Programs, each with up to ten Ramp and ten Soak segments. These can be combined to form up to two programs with each program having up to twenty Ramp and twenty Soak segments (40 total). Run or Hold of program is keyboard or remote digital switch selectable. Each Soak Segment may have a unique Guaranteed Soak Deviation value. Each Ramp and Soak Segment can be configured to use any one of the four PID Sets.

**Miscellaneous Features (continued)**

**Setpoint Rate** – Lets you define a ramp rate to be applied to any local setpoint change. A separate upscale or downscale rate is configurable. A single setpoint ramp is also available as an alternative.

**Output Rate Limiter** – A maximum output rate may be configured for both the upscale and the downscale output directions.

**Data Security** – Five levels of keyboard security protect tuning, configuration, and calibration data, accessed by a configurable 4-digit code. Nonvolatile EEPROM memory assures data integrity during loss of power.

**Quality/Support** – The UDC3500 is covered by an 18-month warranty and backed up by a toll-free phone number for technical assistance (US Only).

**Accutune III™** – This standard feature provides a truly plug and play tuning algorithm, which will, at the touch of a button or through a digital input, accurately identify and tune any process including those with dead-time and integrating processes. This speeds up and simplifies start-up plus allows retuning at any setpoint. The algorithm used is an improved version of the Accutune II™ algorithm used on previous controllers. Two possibilities are now offered when tuning your process: Fast Tune and Slow Tune.

**Fast Tune** will tune the process in such a way that the temp is reached faster, a slight overshoot will be allowed.

**Slowtune** will minimize overshoot, but it will take more time for the process temperature to reach the target setpoint.

**Heat/Cool (Duplex Tune)** will automatically tune both the heating and cooling sides of the process.

**Fuzzy Logic** – This standard feature uses fuzzy logic to suppress process variable overshoot due to SP changes or externally induced process disturbances. It operates independently from Accutune III™ tuning. It does not change the PID constants, but instead temporarily modifies the internal controller response to suppress overshoot. This allows more aggressive tuning to co-exist with smooth PV response. It can be enabled or disabled depending on the application or the control criteria.

**Diagnostic/Failsafe Outputs** – Continuous diagnostic routines detect failure modes, trigger a failsafe output value and identify the failure to minimize troubleshooting time.

**Miscellaneous Features (continued)**

**HealthWatch (optional)** – Consists of three timers and three counters, each of which can be assigned to track the following UDC3500 controller functions:

**(3) Timers**

- Total Operating Time
- Time in Manual or Automatic Mode
- Time in Alarm
- Time of Digital Input Activation
- Time in “Sooting” State

**(3) Counters**

- Manual Control Mode Counts
- Alarm Trip Counts
- Control Relay Actuations
- Digital Input Actuations
- Outside PV Range Limit Counts
- Failsafe Mode Counts
- Re-tune Counts
- Out of Soak-Band Counts
- Power Cycle Events

Selected Maintenance & Diagnostic data can be accessed from the front panel or via communications. Alarms can be configured to activate when a desired threshold is reached. A security code is required to perform resetting of any of the above listed counter or timer functions.

**Real Time Clock (optional)** – A battery-backed clock feature that allows the user to perform such things as starting a Setpoint Program on a specific date and time.

**Auto/Manual Station Plus Back-up Control** – A UDC3500 can act as both an Auto/Manual Station PLUS as a back-up PID Controller, should the primary loop controller fail. Since the PID control is sometimes implemented via a PLC, this feature provides a very cost-effective way to insure the process does not have to shutdown or remain in manual mode if the PLC should fail. Switching from the Auto/Manual Station to the back-up control mode is accomplished using the Digital Input option.

**High Noise Immunity** – The controller is designed to provide reliable, error-free performance in industrial environments that often affect highly noise-sensitive digital equipment.

**CE Mark** – Conformity with 73/23/EEC, Low Voltage Directive and 89/336/EEC, the EMC Directive as a standard feature.

**Approval Body Options** – CSA certification and UL listing are available as an option.

**Operator Interface**

**Indicators** – Provide alarm, control mode and temperature unit indication. There is also indicators for which setpoint is active, the status of the control relays, status of the Digital Inputs, when an Accutune III™ process is being performed and whether a Setpoint Program is in Run, Hold or Guaranteed Soak mode.

**Displays** – During normal operation, the upper display is dedicated to the process variable (4-digits) and special annunciator features. During configuration, the upper display provides guidance for the operator through prompts (7-characters). During normal operation the lower display shows key-selected operating parameters such as Output, Setpoints, Inputs, Deviation, active Tuning Parameter Set, Timer Status, or minutes remaining in a setpoint ramp (4 digits). During configuration, the lower display provides guidance for the operator through prompts (8-characters).

You decide how the controller is to interact with the process by selecting, through simple keystrokes, the functions you want.

Multi-language prompts guide the operator step-by-step through the configuration process assuring quick and accurate entry of all configurable parameters. Five languages are available via configuration: English, French, German, Spanish and Italian.

**Decimal Point Location** – Configurable for none, one, two or three places.

**Dedicated Keys** – Provide direct access to setpoint modes and to Setpoint Program operation to simplify and speed operator procedures.

**Alarms (Option)**

Up to four electromechanical alarm relays are available to activate external equipment when preset alarm setpoints are reached. Each of the four alarms can be set to monitor two independent setpoints. Each alarm setpoint can be either high or low alarm. The alarm type can be selected to be either of the inputs, the Process Variable, Deviation, Output, Shed from communications, PV rate of change, or to alarm on manual mode activation. It can also be used as an On or Off event at the beginning or end of a Ramp/Soak segment. Each alarm has a configurable hysteresis configurable 0 to 100% of range.

Also available is a Diagnostic Alarm configuration to monitor the Current Outputs for an open circuit condition. If any of the outputs falls below about 3.5 mA, then the Diagnostic Alarm is activated. This configuration is in addition to whatever alarm configuration was selected. Effectively, the Diagnostic Alarm can be used as an additional Digital Input used to trip an Alarm Relay when a Current Output circuit opens.

- Alarms 1 and 2 can be configured as latching or non-latching.
- Alarm blocking is also available which allows start-up without alarm energized until after the tracked variable first reaches the operating region.
- PV rate of change alarm.
- Loop break alarm.
- Timer output reset.
- Diagnostic Alarm

**Physical Description**









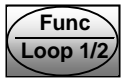

**General Description** -The controller is housed in a 5.8-inch (148 mm) deep, black plastic case with a dark gray elastomer bezel that is panel mounted in a 1/4 DIN cutout. (See Figure 4.) The plug-in chassis allows easy access to the controller board and its various option boards. All power, input, and output wiring are connected to screw terminals on the rear panel. (See Figure 5.)

**UL and CSA Approved Sealed Front Face** – NEMA3R and IP54, or NEMA4X and IP66 with 4 screws. UL and CSA approved as Type 4 moisture protection when used with 4 screws.

## Operator Interface



**Figure 2 – Front Face**

Display Indicators	
<p><b>3500</b> Upper display with 4 larger digits shows Process Variable value (normal operation) and special annunciator features. During Configuration, the upper display provides guidance for the operator through prompts (7 – characters)</p> <p><b>SP 3500</b> During normal operation, the lower display shows key-selected operating parameters such as Output, Setpoints, Inputs, Deviation, active Tuning Parameter Set, Timer Status, or minutes remaining in a setpoint ramp (4 digits). During configuration, the lower display provides guidance for the operator through prompts (8-characters).</p> <p><b>ALM</b> Alarm 1 through 4 annunciations.</p> <p><b>DI</b> Digital Input 1 through 4 annunciations.</p>	<p><b>OUT</b> Control Relay 1 through 4 annunciations.</p> <p><b>F</b> or <b>C</b> Indicates either degrees Fahrenheit or Centigrade.</p> <p><b>MAN</b> or <b>A</b> Indicates either Manual or Auto mode.</p> <p><b>SP</b> Indicates Local Setpoint #1. The lower display also shows other control information and other setpoints. A bar is lighted next to the lower display when the setpoint currently being used is shown on the lower display.</p>
Keys and Functions	
<p> Selects functions within each configuration group. Switches between Loop Displays for Two Loop and Cascade units.</p> <p> Scrolls through the configuration groups.</p> <p> Returns Controller to normal display from Set Up mode. Toggles various operating parameters for display.</p> <p> Increases setpoint or output value. Increases the configuration values or changes functions in Configuration mode groups.</p> <p> Infrared transceiver</p>	<p> Selects Manual or Auto mode.</p> <p> Hold key down to cycle through configured setpoints.</p> <p> Enables Run/Hold of the SP Ramp or Program plus Timer start.</p> <p> Decreases setpoint or output value. Decreases the configuration values or changes functions in Configuration mode groups.</p> <p> NEMA4X and IP66 screw attachment (each corner)</p>

## Process Instrument Explorer (P.I.E.)

### Features

- Create configurations with intuitive software program running on a Pocket PC, a Desktop or a laptop computer.
- Create/edit configurations live. Just connect software to the controller via a communications port.
- Create/edit configurations offline and download to controller later via a communications port.
- Communication types available on every UDC3500:
  - Infrared (standard)
  - RS-485 (optional)
  - Ethernet (optional)
- Same port types on UDC2500 and UDC3200 allow interconnectivity
- This software is available in English, Spanish, Italian, German and French.
- For more information, see Honeywell Part Number 50001619-001

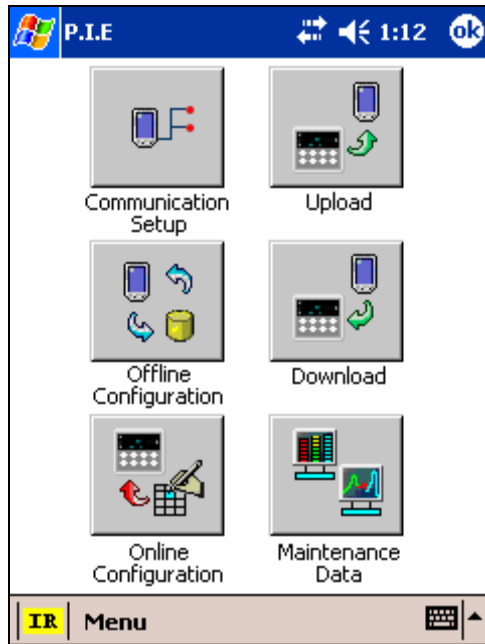

Screen capture of the configuration software running on a Pocket PC

### Infrared Communications

The infrared connection provides a non-intrusive wireless connection with the instrument and maintains NEMA4X and IP66 integrity.

No need to get access to the back of the controller to communicate with the instrument, no need to take your screw driver to wire the communication cable, no wiring mistake possible! You can now duplicate an instrument's configuration, upload or download a new configuration in a matter of seconds, just by pointing your Pocket PC in the direction of the instrument.

**Aim & Upload!** It takes less than 2 seconds to upload a configuration from an instrument! You can then save the configuration file onto your PC or pocket PC for review, modification or archiving.

Furthermore, this software also gives you important maintenance information on the controller: instantly, get information on the current operating parameters, digital inputs and alarm status, identify internal or analog input problems.

**Question:** What if I have several controllers on the same panel? How can I be sure I am communicating with the correct one?

**Answer:** The Infrared port is normally "off". You activate the infrared port on a particular controller by pressing any key. You can now communicate with the controller. If no communications are received for 4 minutes, the IR port will be shut down again. Each controller may also be assigned a different communications address.



## Ethernet Communications

Widely used by manufacturers, the Ethernet connection, which uses Modbus TCP/IP, allows the controller to connect to other Ethernet networks and exchange data with computers or devices on that network for monitoring or managing your process from almost any location.

The Ethernet cable can be connected to a hub (using a straight through cable) or directly to a PC (using a crossed cable or straight through cable reconfigured at the UDC3500 terminals)

The controller can be configured via the P.I.E. software. This software allows the user to configure all of the parameters included in the instrument and to monitor various parameters in the controller.

The controller can be configured to send an Email when an alarm condition has been encountered. The Email address and gateway are configured using the P.I.E. software.

## Specifications

Design	
<b>CE Conformity (Europe)</b>	This product is in conformity with the protection requirements of the following European Council Directives: <b>73/23/EEC</b> , the Low Voltage Directive, and <b>89/336/EEC</b> , the EMC Directive. Conformity of this product with any other "CE Mark" Directive(s) shall not be assumed.
<b>Product Classification</b>	<i>Class I:</i> Permanently Connected, Panel Mounted Industrial Control Equipment with protective earthing (grounding).
<b>Enclosure Rating</b>	<i>Panel Mounted Equipment:</i> This controller must be panel mounted. Terminals must be within the panel enclosure.  <i>Front Bezel:</i> NEMA3R and IP54, or NEMA4X and IP66 with 4 screws. UL and CSA approved as Type 4 moisture protection when used with 4 screws.
<b>Installation Category (Overvoltage Category)</b>	<i>Category II:</i> Energy-consuming equipment supplied from the fixed installation. Local level appliances, and Industrial Control Equipment.
<b>Pollution Degree</b>	<i>Pollution Degree 2:</i> Normally non-conductive pollution with occasional conductivity caused by condensation. (Ref. IEC 664-1)
<b>EMC Classification</b>	Group 1, Class A, ISM Equipment (EN 55011, emissions), Industrial Equipment (EN61326, immunity)
<b>Method of EMC Assessment</b>	Technical File (TF)
<b>Declaration of Conformity</b>	51453681
<b>Approval Body Ratings</b>	<i>UL Listed (Optional):</i> UL61010C-1 <i>CSA Certified (Optional):</i> CSA1010-1 <i>Front Bezel:</i> UL and CSA approved as Type 4 moisture protection when used with 4 screws.
<b>Analog Inputs</b>	Up to three Universal analog inputs. These can easily be configured to operate as two Universal and two High Level inputs or as one Universal and four High Level inputs. <i>Accuracy:</i> <ul style="list-style-type: none"> <li>± 0.10% of full scale typical (± 1 digit for display)</li> <li>Can be field calibrated to ± 0.05% of full scale typical</li> <li>16-bit resolution typical</li> </ul> <i>Sampling Rate:</i> All inputs are sampled six times per second <i>Temperature Stability:</i> ± 0.0075% of Full Scale span / °C change typical <i>Input Impedance:</i> <ul style="list-style-type: none"> <li>0-20 and 4-20 Milliampere Inputs: 250 ohms</li> <li>0-10 Volt and -1 to +1 Volt Inputs: 200K ohms</li> <li>All Others: 10 megohms</li> </ul> <i>Maximum Lead Wire Resistance:</i> <ul style="list-style-type: none"> <li>Thermocouples: 50 ohms/leg</li> <li>100 ohm, 200 ohm, 500 ohm and 1000 ohm RTD: 100 ohms/leg</li> <li>100 ohm Low RTD: 10 ohms/leg</li> </ul> <i>Slidewire Input for Position Proportional Control (Input 3 only):</i> <ul style="list-style-type: none"> <li>100 ohm to 1000 ohm slidewire types</li> <li>Herculine<sup>®</sup> Models 10260 and 11280 Slidewire Emulation</li> </ul>
<b>Analog Input Signal Failure Operation</b>	<i>Burnout Selections:</i> Upscale, Downscale, Failsafe or None <i>Thermocouple Health:</i> Good, Failing, Failure Imminent or Failed <i>Failsafe Output Level:</i> Configurable 0-100% of Output range
<b>Stray Rejection</b>	<b>Common Mode</b> <i>AC (50 or 60 Hz):</i> 120 dB (with maximum source impedance of 100 ohms) or ± 1 LSB (least significant bit) whichever is greater with line voltage applied. <i>DC:</i> 120 dB (with maximum source impedance of 100 ohms) or a ±1 LSB whichever is greater with 120 Vdc applied. <i>DC (to 1 KHz):</i> 80 dB (with maximum source of impedance of 100 ohms) or ±1 LSB whichever is greater with 50 Vac applied. <b>Normal Mode</b> <i>AC (50 or 60 Hz):</i> 60 dB (with 100 % span peak-to-peak maximum)
<b>Digital Inputs (Four) (Optional)</b>	+30 Vdc source for external dry contacts or isolated solid state contacts. Digital Inputs are isolated from line power, earth ground, analog inputs and all outputs.

## Specifications

<b>Design</b>	
<b>Current and Auxiliary Outputs</b>	<p>Up to three Milliamp Outputs. These outputs provide a 0 to 21 mA current output into a negative or positive grounded load or into a non-grounded load. Current outputs are isolated from each other, line power, earth ground and all inputs. Outputs can easily be configured via the keyboard to be 0 to 20 mA or 4 to 20 mA without field calibration and for either direct or reverse action when used as a control output.</p> <p>Any current output not being used as a control output can be used in an Auxiliary Output mode. Auxiliary Outputs can be configured to represent any Analog Input, PV, Setpoint, Deviation, or Control Output. The range of an Auxiliary Output can be scaled per the range of the selected variable and can be set anywhere between 0 to 21 mA.</p> <p><i>Resolution:</i> 14 bits over 0 to 21 mA  <i>Accuracy:</i> 0.05% of full scale  <i>Temperature Stability:</i> 0.01% F.S./°C  <i>Load Resistance:</i> 0 to 1000 ohms</p> <p>The First Current Output is a standard feature and is present on all instruments. The Second Current Output is an option and is mutually exclusive with Ethernet Communications. The Third Current Output is an option and is mutually exclusive with the other Output 2 Options listed directly below.</p>
<b>Output 2 Options</b>	<p><b>Output 2</b> is a socket which may be populated with any one of the following output types:</p> <p><b>Electromechanical Relay</b>            SPDT contacts. Both Normally Open and Normally Closed contacts are brought out to the rear terminals.  <i>Resistive Load:</i> 5 amps @ 120 Vac or 240 Vac or 30 Vdc  <i>Inductive Load (cosφ = 0.4):</i> 3 amps @ 130 Vac or 250 Vac  <i>Inductive Load (L/R = 7 milliseconds):</i> 3.5 amps @ 30 Vdc  <i>Motor:</i> 1/6 H.P.</p> <p><b>Dual Electromechanical Relays</b>            Two SPST relays. One Normally Open contact for each relay is brought out to the rear terminals. This option must be used as the Loop 1 output for On-Off Duplex, Time Duplex, Three Position Step Control and Position Proportional Control applications. Instruments with this option can have a total of five relays plus one or two current outputs.  <i>Resistive Load:</i> 2 amps @ 120 Vac, 240 Vac or 30 Vdc  <i>Inductive Load (cosφ = 0.4):</i> 1 amp @ 130 Vac or 250 Vac  <i>Inductive Load (L/R = 7 milliseconds):</i> 1 amp @ 30 Vdc</p> <p><b>Solid State Relay</b>            SPST solid-state contact consisting of a triac N.O. output with zero-crossing detection.  <i>Resistive Load:</i> 1.0 amp @ 25°C ambient temperature and 120 or 240 Vac                              0.5 amp @ 55°C ambient temperature and 120 or 240 Vac  <i>Inductive Load:</i> 50 VA @ 55°C ambient temperature and 120 or 240 Vac  <i>Minimum Load:</i> 20 milliamps</p> <p><b>Open Collector Output</b>            Transistor drive for powering an external relay. Isolated from earth ground and all other circuits except the First Current Output. Internally powered @ 30 Vdc.            Note: Applying an external power supply to this output will damage the instrument.  <i>Maximum Sink Current:</i> 20 mA  <i>Overload Protection:</i> 100 mA</p> <p><b>Third Current Output</b>            See above.</p>
<b>Three Relay Board (Optional)</b>	<p>Three SPDT contacts. Both Normally Open and Normally Closed contacts are brought out to the rear terminals for each relay. These relays are used for Alarm outputs or for the output of the second control loop. They may also be used as outputs for Logic Gate functions.</p> <p><i>Resistive Load:</i> 5 amps @ 120 Vac or 240 Vac or 30 Vdc  <i>Inductive Load (cosφ = 0.4):</i> 3 amps @ 130 Vac or 250 Vac  <i>Inductive Load (L/R = 7 milliseconds):</i> 3.5 amps @ 30 Vdc  <i>Motor:</i> 1/6 H.P.</p>



## Specifications

Design	
<b>Alarm Outputs (Optional)</b>	A maximum of four alarm relays are available, depending upon the type and quantity of outputs used for control purposes. Each alarm may have one or two setpoints, each of which can be independently set as high or low alarm. Setpoints can be on any Input, Process Variable, Deviation, Manual Mode, Failsafe, PV Rate, RSP Mode, Communication Shed, or Output. A single adjustable hysteresis of 0.0 to 100.0% is provided. The alarm can also be set as an ON or OFF event at the beginning of a Setpoint Program Ramp or Soak segment. Alarm status is accessible via any communications port and is shown on the display annunciators.
<b>Isolation (Functional)</b>	<p><i>AC Power:</i> Electrically isolated from all other inputs and outputs and earth ground to withstand a HIPOT potential of 1900 Vdc for 2 seconds per Annex K of EN61010-1.</p> <p><i>Analog Inputs and Outputs:</i> Electrically isolated from all other circuits to withstand a HIPOT potential of 850 Vdc for 2 seconds per Annex K of EN61010-1.</p> <p><i>Digital Inputs and Digital Outputs:</i> Electrically isolated from all other circuits to withstand a HIPOT potential of 850 Vdc for 2 seconds per Annex K of EN61010-1.</p> <p><i>Relay Contacts:</i> With a working voltage of 115/230 Vac, these are electrically isolated from all other circuits to withstand a HIPOT potential of 345 Vdc for 2 seconds per Annex K of EN61010-1</p>
<b>RS422/485 Modbus RTU Communications Interface (Optional)</b>	<p><i>Baud Rate:</i> 4800, 9600,19,200 or 38,400 baud selectable</p> <p><i>Data Format:</i> Floating point or integer</p> <p><i>Length of Link:</i>            2000 ft (600 m) max. with Belden 9271 Twinax Cable and 120 ohm termination resistors            4000 ft. (1200 m) max. with Belden 8227 Twinax Cable and 100 ohm termination resistors</p> <p><i>Link Characteristics:</i> Two-wire (half-duplex), multi-drop Modbus RTU protocol, 15 drops maximum or up to 31 drops for shorter link length.</p>
<b>Ethernet TCP/IP Communications Interface (Optional)</b>	<p><i>Type:</i> 10Base-T</p> <p><i>Length of Link:</i> 330 ft. (100 m) maximum. Use Shielded twisted-pair, Category 5 (STP CAT5) Ethernet cable.</p> <p><i>Link Characteristics:</i> Four-wire plus shield, single drop, five hops maximum</p> <p><i>IP Address:</i> IP Address is 10.0.0.2 as shipped from the Factory</p> <p><i>Recommended network configuration:</i> Use Switch rather than Hub in order to maximize UDC Ethernet performance</p> <p><i>Configuration:</i> Ethernet parameters are configured via the Process Instrument Explorer.</p> <p><i>Email:</i> The capacity to send two Emails is provided. These must be configured via the Process Instrument Explorer. It is recommended that the Real Time Clock option be purchased for any instrument that needs to send Email.</p> <p>Ethernet Communications is mutually exclusive with the Second Current Output.</p>
<b>RS-485 and Ethernet Transaction rates</b>	Host computer must allow a minimum of 20 milliseconds between Read transactions and a minimum of 200 milliseconds between Write transactions.
<b>Infrared Communications (Standard)</b>	<p><i>Type:</i> Serial Infrared (SIR)</p> <p><i>Length of Link:</i> 3 ft. (1 m) maximum for IrDA 1.0 compliant devices</p> <p><i>Baud Rate:</i> 19,200 or 38,400 baud selectable</p>
<b>Power Consumption</b>	<p>24 VA maximum (90 to 264 Vac)</p> <p>18 VA maximum (24 Vac/dc)</p>
<b>Power Inrush Current</b>	<p>10A maximum for 4 milliseconds (under operating conditions), reducing to a maximum of 265 mA (90 to 264 Vac operation) or 900 mA (24 Vac/dc operation) after one second.</p> <p><b>CAUTION</b> When applying power to more than one instrument, make sure that sufficient power is supplied. Otherwise, the instruments may not start up normally due to voltage drop from the inrush current.</p>
<b>Weight</b>	3 lbs. (1.3 kg)

## Specifications

### Environmental and Operating Conditions

Parameter	Reference	Rated	Operative Limits	Transportation and Storage
<b>Ambient Temperature</b>	25 ± 3°C 77 ± 5°F	15 to 55°C 58 to 131°F	0 to 55°C 32 to 131°F	-40 to 66°C -40 to 151°F
<b>Relative Humidity</b>	10 to 55*	10 to 90*	5 to 90*	5 to 95*
<b>Vibration</b> Frequency (Hz) Acceleration (g)	0 0	0 to 70 0.4	0 to 200 0.6	0 to 200 0.5
<b>Mechanical Shock</b> Acceleration (g) Duration (ms)	0 0	1 30	5 30	20 30
<b>Line Voltage (Vdc)</b>	+24 ±1	+22 to +27	+20 to +30	--
<b>Line Voltage (Vac)</b> <b>90 to 264 Vac</b>	120 ±1 240 ±2	90 to 240	90 to 264	-- --
<b>24 Vac</b>	24 ± 1	20 to 27	20 to 27	--
<b>Frequency (Hz)</b> (For Vac)	50 ±0.2 60 ±0.2	49 to 51 59 to 61	48 to 52 58 to 62	-- --

\* The maximum RH rating applies only up to 40°C (104°F). For higher temperatures, the RH specification is derated to maintain constant moisture content.

### General Reference Data

<b>Isolation (Functional)</b>	<p><i>AC Power:</i> Electrically isolated from all other inputs and outputs and earth ground to withstand a HIPOT potential of 1900 Vdc for 2 seconds per Annex K of EN61010-1.</p> <p><i>Analog Inputs and Outputs:</i> Are isolated from each other and all other circuits at 850 Vdc for 2 seconds.</p> <p><i>Digital Inputs and Digital Outputs:</i> Electrically isolated from all other circuits to withstand a HIPOT potential of 850 Vdc for 2 seconds per Annex K of EN61010-1.</p> <p><i>Relay Contacts:</i> With a working voltage of 115/230 Vac, these are electrically isolated from all other circuits to withstand a HIPOT potential of 345 Vdc for 2 seconds per Annex K of EN61010-1</p>
<b>Surge Withstand Capability (SWC)</b>	<p><i>Immunity:</i> ANSI/IEEE C37.90.1, Surge Withstand Capability (SWC) (Formerly IEEE 472). Mains power input and relay contact outputs: 2.5 kV, Common Mode and Differential Mode. All other circuits: 1.0 kV, Common Mode and Differential Mode. The instrument is capable of meeting these test levels with no component failures, no reset, and no incorrect outputs.</p>
<b>Radio Frequency Interference (RFI)</b>	<p><i>Immunity:</i> No effect on performance from a 5 W walkie-talkie operated at 27, 151 or 450 MHz, one meter from the controller.</p>

**Table 1—Input Actuators**

Input Actuation	Range	
	°F	°C
<b>Thermocouples (Per ITS-90)</b>		
B	0 to 3300	-18 to 1816
E	-454 to 1832	-270 to 1000
E (low)	-200 to 1100	-129 to 593
J	0 to 1600	-18 to 871
J (med)	20 to 900	-7 to 482
J (low)	20 to 550	-7 to 288
K	0 to 2400	-18 to 1316
K (med)	-20 to 1200	-29 to 649
K (low)	-20 to 750	-29 to 399
NiMoNiCo (NNM)	32 to 2500	0 to 1371
NNM (low)	32 to 1260	0 to 682
Nicrosil-Nisil (NIC)	0 to 2372	-18 to 1300
NIC (low)	0 to 1472	-18 to 800
Platinell	32 to 2516	0 to 1380
Platinell (low)	32 to 1382	0 to 750
R	0 to 3100	-18 to 1704
S	0 to 3100	-18 to 1704
T	-300 to 700	-184 to 371
T (low)	-200 to 500	-129 to 260
W5W26	0 to 4200	-18 to 2315
W5W26 (low)	0 to 2240	-18 to 1227
PR40-PR20	32 to 3216	0 to 1880
<b>Honeywell Radimatic</b>		
Type RH	0 to 3400	-18 to 1871
Type RI	0 to 9999 max <sup>(1)</sup>	-18 to 9999 max <sup>(1)</sup>
<b>Thermocouple Differential<sup>(2)</sup></b>	-50 to 150	-46 to 66
<b>RTD Per IEC-60751 (1995) IEC Alpha = 0.00385</b>		
100 ohms	-300 to 1200	-184 to 649
100 ohms (low) <sup>(3)</sup>	-300 to 300	-184 to 149
200 ohms	-300 to 1200	-184 to 649
500 ohms	-300 to 1200	-184 to 649
1000 ohms	-300 to 1200	-184 to 649
<sup>(1)</sup> User enters the range values manually per RI type and application.		
<sup>(2)</sup> Factory calibrated for pair of J thermocouples at an ambient temperature mean of 450°F / 232°C. Can be Field Calibrated for other thermocouple types and ranges.		
<sup>(3)</sup> The Relative Humidity (RH) algorithm requires the use of two inputs, both configured for RTD 100 ohms (low). Input 1 reads the Wet Bulb temperature and Input 2 reads the Dry Bulb temperature.		

Input Actuation	Range
<b>Linear</b>	
Milliamps	4 to 20 mA <sup>(4) (5)</sup> 0 to 20 mA <sup>(4) (5)</sup>
Millivolts	0 to 10 mV 0 to 50 mV 0 to 100 mV 0 to 500 mV -10 to 10 mV
Volts	1 to 5 V <sup>(5)</sup> 0 to 1 V 0 to 5 V <sup>(5)</sup> 0 to 10V <sup>(4)</sup> -1 to 1 V <sup>(4)</sup>
<b>Combinational<sup>(6)</sup></b>	
Carbon Probe Oxygen Probe	0 to 1250 mV -30 to 510 mV
<b>Slidewire</b>	
Resistive Herculine <sup>®</sup>	0 to 1000 ohms <sup>(7)</sup> 10260 and 11280 Slidewire Emulation
<sup>(4)</sup> Requires external dropping resistor assembly (Honeywell supplied).	
<sup>(5)</sup> When Input 2 is configured for one of these High Level input types, then Input 4 may be enabled and configured for one of these High Level input types. Likewise, when Input 3 is configured for one of these input types, then Input 5 may be enabled and configured for one of these input types.	
<sup>(6)</sup> Combinational types require the use of two inputs. The Carbon or Oxygen Probe is on Input 1 and the temperature sensor is on Input 2. Percent Carbon Monoxide (PCO) may be entered into a Carbon algorithm as either a fixed value or as a live value from Input 3.	
<sup>(7)</sup> This is the resistive input range. The slidewires themselves should be 100 ohm to 1000 ohm types.	

## Model Number Interpretation

### Instructions

- Select the desired key number. The arrow to the right marks the selection available.
- Make the desired selections from Tables I through VI using the column below the proper arrow. A dot (•) denotes availability.

Key Number    I    II    III    IV    V    VI  
 [ ] - [ ] - [ ] - [ ] - [ ] - [ ]

### KEY NUMBER - UDC3500 Single & Dual Loop Controller

Description
Digital Controller for use with 90 to 264Vac Power + Current Output #1
Digital Controller for use with 24Vac/dc Power + Current Output #1

Selection	Availability
DC3500	↓
DC3501	↓

**TABLE I - Specify optional Output and/or Alarms**

Output #2	None
	Current Output (4 to 20mA, 0 to 20 mA) (Current Output #3)
	Electro Mechanical Relay (5 Amp Form C)
	Solid State 1 Amp (Zero-Crossing Type)
	Open Collector transistor output
Relay Outputs #3, #4 and #5	Dual 2 Amp Relays (Form A) (Heat/Cool, Pos Prop, TPSC, Relays 1 & 2)
	None
	Three (3) E-M Relay (5 Amp Form C)

O_	•	•
C_	•	•
E_	•	•
A_	•	•
T_	•	•
R_	•	•
_0	•	•
_E	•	•

**TABLE II - Communications and Software Selections**

Communications	None
	Current Output #2 + (4) Digital Inputs
	Current Output #2 + (4) Digital Inputs + Modbus RS-485
	10 Base-T Ethernet (Modbus RTU) + (4) Digital Inputs
Software Selections	Standard Functions, Includes Accutune
	Math Option
	Set Point Programming (1 Program, 20 Segments)
	Set Point Programming Plus Math
	HealthWatch
	SPP + HealthWatch
	Math + HealthWatch
SPP + Math + HealthWatch	
Enhanced	Enhanced SPP (4 Programs, 20 Segments Each)
	Enhanced SPP + Math
	Enhanced SPP + HealthWatch
	Enhanced SPP + Math + HealthWatch
Loops of Control	Single Loop
	2 Loops + Internal Cascade
Real-Time Clock	None
	Real-Time Clock (RTC)

0_ _ _	•	•
1_ _ _	•	•
2_ _ _	•	•
3_ _ _	•	•
_0_ _	•	•
_A_ _	•	•
_B_ _	•	•
_C_ _	•	•
_D_ _	•	•
_E_ _	•	•
_F_ _	•	•
_G_ _	•	•
_H_ _	•	•
_J_ _	•	•
_K_ _	•	•
_L_ _	•	•
_ _0_	•	•
_ _2_	•	•
_ _ _0	•	•
_ _ _C	•	•

**TABLE III - Input types can be changed in the field**

Input 1	TC, RTD, mV, 0-5V, 1-5V
	TC, RTD, mV, 0-5V, 1-5V, 0-20mA, 4-20mA
	TC, RTD, mV, 0-5V, 1-5V, 0-20mA, 4-20mA, -1-1V, 0-10V
	Relative Humidity (Requires Input 2)
	Carbon, Oxygen or Dewpoint (Requires Input 2)
Input 2	None
	TC, RTD, mV, 0-5V, 1-5V, 0-20mA, 4-20mA
	TC, RTD, mV, 0-5V, 1-5V, 0-20mA, 4-20mA, -1-1V, 0-10V
	Two HLAI instead of 1 LLAI
Input 3	None
	TC, RTD, mV, 0-5V, 1-5V, 0-20mA, 4-20mA
	TC, RTD, mV, 0-5V, 1-5V, 0-20mA, 4-20mA, -1-1V, 0-10V
	Two HLAI instead of 1 LLAI Slidewire Input for Position Prop. (Requires Dual Relay Output)

Selection	Availability	
	DC 3500	3501
1__	•	•
2__	•	•
3__	•	•
15_	•	•
16_	•	•
_0_	•	•
_1_	•	•
_2_	•	•
_3_	•	•
_0	•	•
_1	•	•
_2	•	•
_3	•	•
_4	a	a

**TABLE IV - Options**

Approvals	CE (Standard)
	CE, UL and CSA
Tags	None
	Stainless Steel Customer ID Tag - 3 lines w/22 characters/line
Special Options	None
	Custom Calibration (0.05%) For one Range Type Only <b>(Note 1)</b>
Future Options	None
	None

0----	•	•
1----	•	•
_0---	•	•
_T---	•	•
_0	•	•
_1	•	•
_0	•	•
_0	•	•

**TABLE V - Product Manuals**

Manuals	Product Information on CD - (English)
	English Manual (Hard Copy)
	French Manual (Hard Copy)
	German Manual (Hard Copy)
	Italian Manual (Hard Copy)
	Spanish Manual (Hard Copy)
Certificate	None
	Certificate of Conformance (F3391)

0_	•	•
E_	•	•
F_		
G_		
I_		
S_		
_0	•	•
_C	•	•

**TABLE VI**

	None
--	------

0	•	•
---	---	---

**RESTRICTIONS**

Restriction Letters	Available Only With		Not Available With	
	Table	Selection	Table	Selection
a	I	R_		

Figure 3—UDC3500 Model Selection Guide

## Dimensions

The controller is housed in a 5.8-inch (148 mm) deep, black plastic case with a dark gray elastomer bezel that can be panel mounted in a 1/4 DIN cutout. The plug-in chassis allows easy access to the controller board and its various option boards. All power, input, and output wiring are connected to screw terminals on the rear panel. (See Figure 5.)

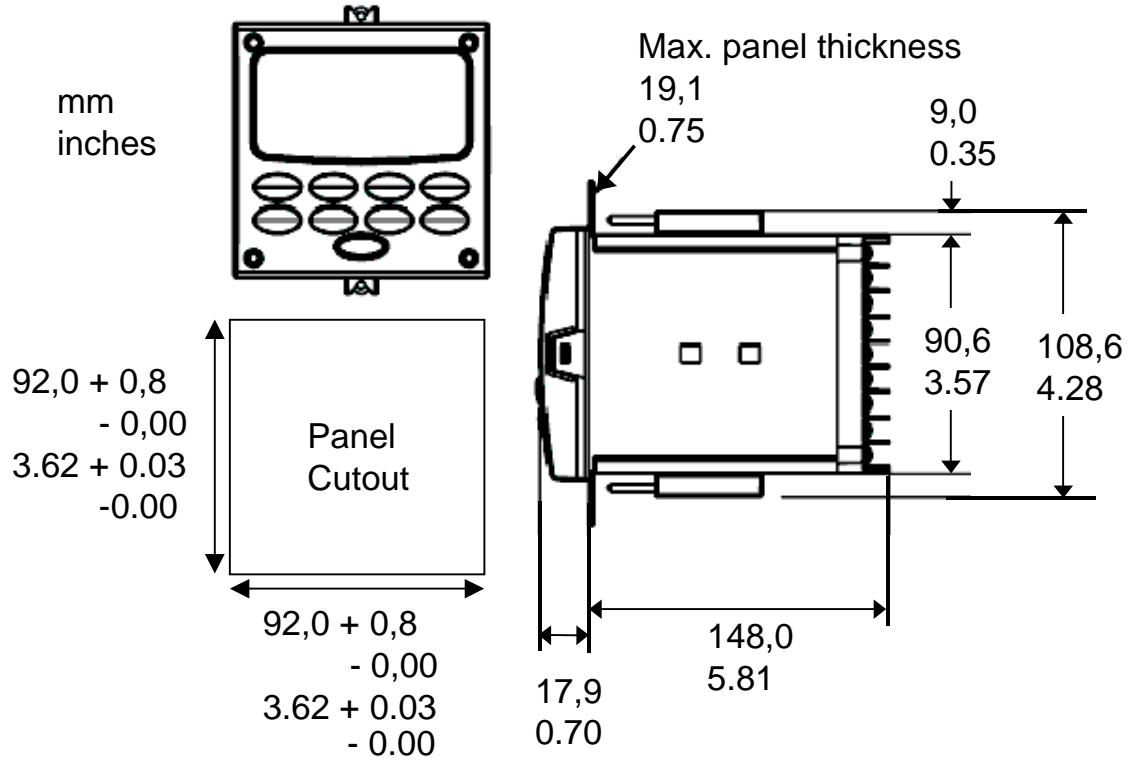
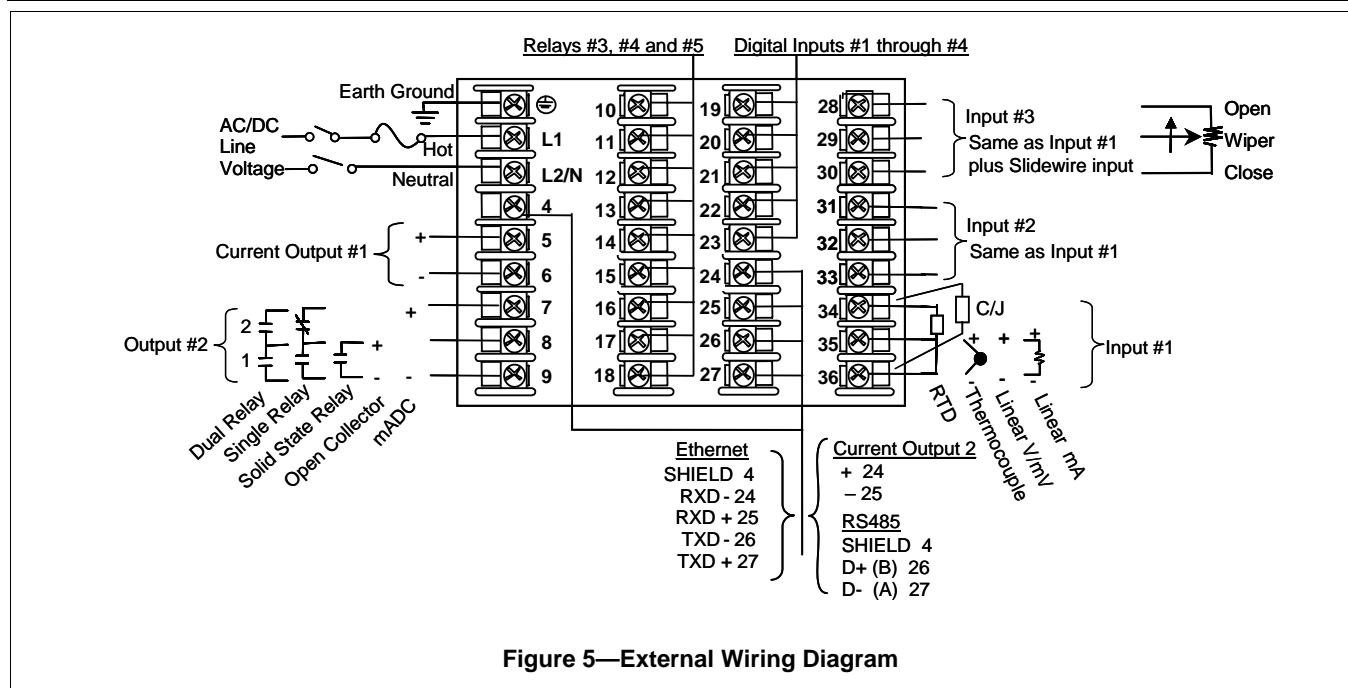

Figure 4—UDC3500 Controller and Cutout Dimensions

## Wiring Diagram



## Ordering Information

For the complete ordering information on the UDC3500, request Model Selection Guide 51-51-16-81.

Honeywell offers a full line of Sensors, Transmitters, and Final Control Devices for use with the UDC3500 Universal Digital Controller. These devices include:

- Thermocouples,
- RTDs,
- Pressure Transmitters,
- Flow Transmitters,
- Liquid Level Transmitters,
- Valves,
- Actuators, and
- Electric Motors.

*Specifications are subject to change without notice.*

® Modbus is a trademark of AEG Modicon

---

**Warranty/Remedy**

---

Honeywell warrants goods of its manufacture as being free of defective materials and faulty workmanship. Contact your local sales office for warranty information. If warranted goods are returned to Honeywell during the period of coverage, Honeywell will repair or replace without charge those items it finds defective. The foregoing is Buyer's sole remedy and is **in lieu of all other warranties, expressed or implied, including those of merchantability and fitness for a particular purpose**. Specifications may change without notice. The information we supply is believed to be accurate and reliable as of this printing. However, we assume no responsibility for its use.

While we provide application assistance personally, through our literature and the Honeywell web site, it is up to the customer to determine the suitability of the product in the application.

Distributor :

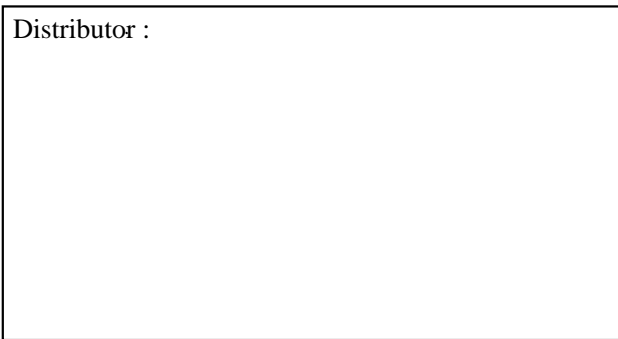

For more information, contact Honeywell sales at:  
US: 1-800-343-0228  
Canada: 1-800-461-0013

---

**Honeywell Process Solutions**  
**Industrial Measurement and Control**  
512 Virginia Drive  
Fort Washington, PA 19034