

DPR 100 C - DPR 100 D
PRODUCT MANUAL

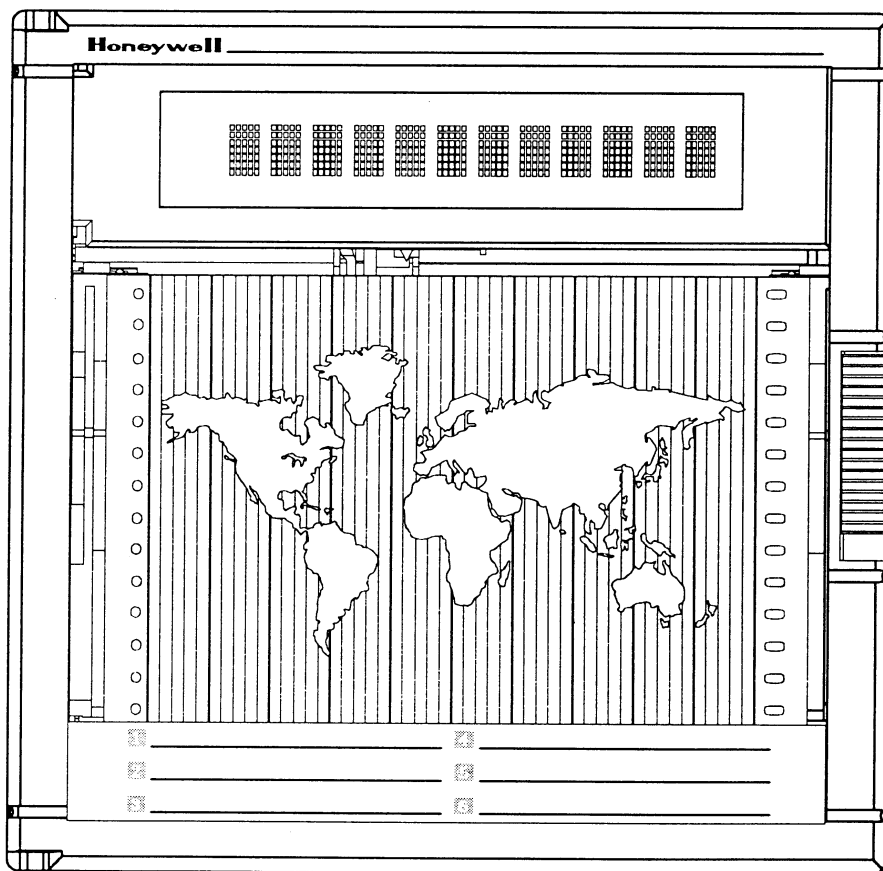

LEADERLINE

Better Record Your World

DPR 100 C - DPR 100 D

PRODUCT MANUAL

Ref. : US1I-6137

Issue :19

October, 2003

Copyright, Notices, and Trademarks

© Copyright 2000 by Honeywell Inc.

While this information is presented in good faith and believed to be accurate, Honeywell disclaims the implied warranties of merchantability and fitness for a particular purpose and makes no express warranties except as may be stated in its written agreement with and for its customer.

In no event is Honeywell liable to anyone for any indirect, special or consequential damages. The information and specifications in this document are subject to change without notice.

This document was prepared using Information Mapping methodologies and formatting principles.

Information Mapping is a trademark of Information Mapping Inc.
Windows is a registered trademark of Microsoft Inc.
Modbus is a registered trademark of MODICON, Inc.
The omission of a name from this list is not to be interpreted that the name is not a trademark.

About This Document

Abstract

This manual describes the installation, configuration, operation, and maintenance of the Recorder.

Warranty

WARRANTY. THE FOLLOWING IS IN LIEU OF ALL OTHER WARRANTIES, EXPRESS OR IMPLIED, INCLUDING THOSE OF MERCHANTABILITY AND FITNESS FOR PARTICULAR PURPOSE.

a) Goods/Hardware

Except as otherwise hereinafter provided, Honeywell warrants goods of its manufacture to be free of defective materials and faulty workmanship and as conforming to applicable specifications and/or drawings. Commencing with date of shipment, Honeywell's warranty shall run for the period specified on the face hereof or, if none be mentioned, 18 months. If warranted goods are returned to Honeywell during this period of coverage, Honeywell will repair or replace without charge those items it finds defective.

Experimental devices (designated by the letter "X" or "E" within their part-number identification) are prototype, pre-production items that have yet to complete all phases of product-release testing; these items are sold "AS IS" WITH NO WARRANTY.

b) Software

Software, if listed on the face hereof and used within hardware and/or a system warranted by Honeywell, will be furnished on a medium that's free of defect in materials or workmanship under normal use for so long as the hardware and/or system is under warranty. During this period, Honeywell will replace without charge any such medium it finds defective. As for the quality or performance of any software or data, they are supplied "AS IS" WITH NO WARRANTY.

c) Services

Where hardware and/or a system is installed by Honeywell, such services are warranted against faulty workmanship for the same period (if any) as applies to the installed items. During this concurrently running period, Honeywell will correct without charge any workmanship it finds to be faulty.





Contacts

If you encounter any problem with your recorder, please contact your nearest Sales Office. (See the address list at the end of this manual).

An engineer will discuss your problem with you. **Please have your complete model number and serial number available.** Model number and serial number are located on the chassis nameplate.

If it is determined that a hardware problem exists, a replacement instrument or part will be shipped with instructions for returning the defective unit. Do not return your instrument without authorization from your Sales Office or until the replacement has been received.

Symbol Meanings

Symbol	What it means
	Protective ground terminal. Provided for connection of the protective earth green (green or green/yellow) supply system conductor.
	Functional ground terminal. Used for non-safety purposes such as noise immunity improvement.
	WARNING. Risk of electric shock. This symbol warns the user of a potential shock hazard where voltages greater than 30 Vrms, 42.4 Vpeak, or 60 Vdc may be accessible.
	CAUTION. When this symbol appears on the product, see the user manual for more information. This symbol appears next to the required information in the manual.

CE conformity

This product conforms with the protection requirements of the following European Council Directives: 89/336/EEC, the EMC directive, and 73/23/EEC, the low voltage directive. Do not assume this product conforms with any other “CE Mark” Directive(s).

Attention

The emission limits of EN 50081-2 are designed to provide reasonable protection against harmful interference when this equipment is operated in an industrial environment. Operation of this equipment in a residential area may cause harmful interference. This equipment generates, uses, and can radiate radio frequency energy and may cause interference to radio and television reception when the equipment is used closer than 30 meters to the antenna(e). In special cases, when highly susceptible apparatus is used in close proximity, the user may have to employ additional mitigating measures to further reduce the electromagnetic emissions of this equipment.

Product model number:	
Serial number:	
Date code:	
Service department telephone number:	

TABLE OF CONTENTS

1. OVERVIEW	1-1
1.1 RECORDER OVERVIEW	1-1
2. INSTALLATION	2-1
2.1 WARNING	2-1
2.2 UNPACKING	2-2
2.3 PANEL MOUNTING THE RECORDER	2-3
2.3.1 Recommendations.....	2-3
2.3.2 External dimensions and cut-out.....	2-3
2.3.3 Installing the recorder.....	2-4
2.4 WIRING THE RECORDER	2-5
2.4.1 Recommendations.....	2-5
2.5 TECHNICAL CONNECTIONS	2-6
2.6 FITTING THE CHART	2-7
2.6.1 Roll Chart.....	2-7
2.6.2 Fanfold Chart.....	2-8
2.7 INSTALLING THE PRINTING SYSTEM	2-9
2.8 CHECK LIST	2-15
3. OPERATION	3-1
3.1 OPERATING INTERFACE EXPLANATION	3-1
3.2 BASIC ACTIONS	3-2
3.2.1 Operators keys.....	3-2
3.2.2 How to select the display type.....	3-3
4. MODEL SELECTION GUIDE	4-1
4.1 PRODUCT IDENTIFICATION	4-1
5. PRODUCT SPECIFICATION SHEET	5-1
6. CONFIGURATION	6-1
6.1 OPERATOR INTERFACE	6-1
6.2 ONE EXAMPLE: HOW TO SET THE CHART SPEED	6-5
6.2 PROMPTS EXPLANATION	6-6
7. DETAILED CONFIGURATION	7-1
7.1 PARAMETER LIST	7-1
8. SERVICE	8-1
8.1 OPERATOR INTERFACE	8-1
8.1.1 Access to service.....	8-1
8.1.2 Passwords.....	8-1
8.1.3 Main function.....	8-1
8.1.4 Access to functions during service.....	8-2
8.2 LIST OF SERVICES	8-3

TABLE OF CONTENTS

9. PC LOADER	9-1
9.1 OVERVIEW	9-1
9.2 INSTALLATION	9-1
9.2.1 System Requirement	9-1
9.2.2 New Installation	9-2
9.2.3 Upgrade old installation	9-5
9.2.4 Uninstall	9-6
9.3 USE	9-7
9.3.1 Start up	9-7
9.3.2 Menus	9-7
9.3.3 Modifying fields of parameters	9-7
9.3.4 Going from a parameter field to another one	9-7
9.3.5 Leaving a menu	9-7
9.4 SET UP COMM	9-8
9.5 USE	9-9
9.5.1 Read and Modify	9-9
9.5.2 User actuation	9-9
9.6 SERVICE PARAMETERS	9-10
9.7 MONITORING	9-13
9.7.1 Parameters initialization	9-13
9.7.2 Real time display	9-13
9.7.3 Start/stop archiving	9-13
9.8 UPDATE SOFTWARE (FOR JACK ONLY)	9-14
10. TROUBLESHOOTING	10-1
10.1 FAILURE SYMPTOMS AND TROUBLESHOOTING PROCEDURES	10-1
10.2 TROUBLESHOOTING LIST	10-1
10.2.1 Self test mode pen recorder	10-1
10.2.2 Self test mode multipoint recorder	10-5
10.2.3 Symptom: The recorder is inoperative	10-8
10.2.4 Symptom: The display is inoperative	10-8
10.2.5 Symptom: The chart is inoperative	10-8
10.2.6 Symptom: The print carriage is inoperative	10-9
10.2.7 Symptom: The print head is inoperative	10-10
10.2.8 Symptom: Printing incorrect color	10-10
10.2.9 Symptom: Wrong date/time	10-11
10.2.10 Symptom: The alarm relay is inoperative	10-11
10.2.11 Symptom: Analog input out of tolerance	10-11
10.2.12 Symptom: Incorrect spacing between points	10-12
10.2.13 Symptom: No communication with PC loader	10-12
10.2.14 Symptom: Printed traces are unstable	10-12
10.2.15 Symptom: Chart illumination failed	10-13
10.2.16 Symptom: Current output failed	10-13
10.3 ERROR MESSAGES	10-14
11. KITS LIST	11-1
11.1 ELECTRONIC PARTS	11-2
11.2 MECHANICAL PARTS	11-3
11.3 MISCELLANEOUS	11-4
11.4 CONSUMABLES	11-5
12. PROMPTS TRANSLATION	12-1
12.1 MATRICES	12-1

TABLE OF CONTENTS

12.2	SERVICE	12-9
12.3	MESSAGES DURING THE RUN DISPLAY	12-12
13.	CONFIGURATION WORKSHEET	13-1
13.1	ANALOG INPUTS	13-1
13.2	ANALOG ALARMS	13-1
13.3	MATH	13-2
13.4	DIGITAL INPUTS	13-2
13.5	MESSAGES	13-3
13.6	CHART	13-3
13.7	MISCELLANEOUS	13-4
13.8	BATCH	13-4
13.9	PRINTER	13-5
13.10	EVENT	13-6
13.11	MMI	13-6
13.12	CURRENT OUTPUT	13-6

SAFETY
SALES AND SERVICE

1.1 RECORDER OVERVIEW

This recorder is a precision measuring instrument with many features.

- Up to 3 pens for the pen recorder or up to 6 channels for the multipoint recorder,
- Compact size: 245 mm depth,
- 100 mm chart in either roll or fanfold presentation,
- Universal power supply: With optional 24 Vdc output voltage to supply up to 2 transmitters,
- IP54 front of panel protection,
- Universal input with wide choice of actuation/range,
- High accuracy: 0.1 % F.S.,
- Easy interactive product configuration,
- Large, clear operator display,
- Fast scanning rate: 330 ms for 3 channels, 640 ms for 6 channels,
- Alphanumeric chart documentation,
- Up to 12 alarm setpoints with a wide choice of alarm types,
- Event alarm: end of chart paper, sensor burnout, clock battery low, etc.,
- Up to 12 customer messages,
- 4 Batch messages,
- Event precursor,
- Standard chart illumination,
- Up to 4 digital inputs,
- Product configurability and service diagnostic with PC software,
- Supervision display via PC software,
- Chart zoning configurable,
- Complies with IEC348 and IEC1010 safety requirements,

1. OVERVIEW

OPTIONS:

- Up to 12 alarm relay outputs,
- Maths functions,
- Up to 2 current output channels (4 to 20 mA).

For the best product performance Honeywell recommends the use of Honeywell charts and pens, use of other manufacturer's charts and pens may degrade product performance.

2. INSTALLATION

2.1 WARNING

IMPROPER INSTALLATION



To avoid the risk of electrical shock which could cause personal injury, follow all safety notices in this documentation.



Protective earth terminal. Provided for connection of the protective earth supply system conductor.

Failure to comply with these instructions could result in death or serious injury

POWER SUPPLY

Ensure the source voltage matches the supply voltage of the recorder before power on.

PROTECTIVE GROUNDING

Make sure to connect the protective grounding to prevent an electric shock before power on.

NECESSITY OF PROTECTIVE GROUNDING

To avoid a potential shock hazard, never cut off the internal or external protective grounding wire or disconnect the wiring of protective grounding terminal.

DEFECT OF PROTECTIVE GROUNDING AND FUSE

Do not operate the instrument when protective grounding or fuse might be defective.

FUSE

To prevent a fire, make sure to use the fuse with specified standard (current voltage, type). Before replacing the fuse, turn off the power and disconnect the power source. Do not use a different fuse or short-circuit the fuseholder.

DO NOT OPERATE IN AN EXPLOSIVE ATMOSPHERE

Do not operate the instrument in the presence of flammable liquids or vapors. Operation of any electrical instrument in such an environment constitutes a safety hazard.

NEVER TOUCH THE INTERIOR OF THE INSTRUMENT

Inside this instrument there are areas of high voltage ; therefore, never touch the interior if the power supply is connected. This instrument has an internal changeable system ; however, internal inspection and adjustments should be done by qualified personnel only.

EXTERNAL CONNECTION

To ground securely, connect the protective grounding before connecting to measurement or control unit.

If the equipment is used in a manner not specified by the manufacturer, the protection provided by the equipment may be impaired.

Do not replace any component (or part) not explicitly specified as replaceable by your supplier.

2. INSTALLATION

2.2 UNPACKING

Remove the accessories and check them against the figure below.

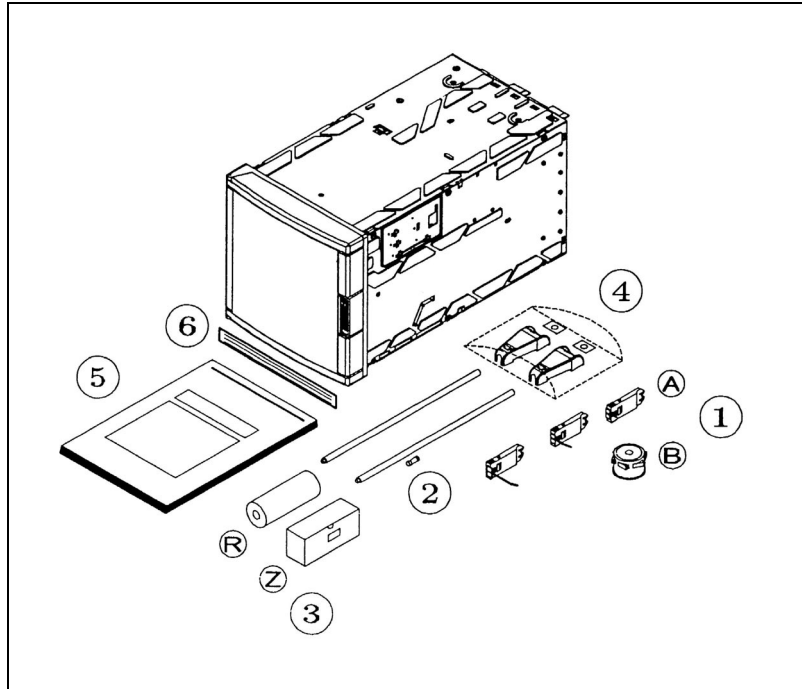

1. Ink cartridge(s) (A) or ink wheel (B)
2. Fuse (Spare)
3. Roll (R) or fanfold (Z) chart
4. Mounting brackets with nuts
5. Operator manual
6. Front label

NOTE: In case of missing item, please contact your nearest sales office.

2. INSTALLATION

2.3 PANEL MOUNTING THE RECORDER

2.3.1 Recommendations

This recorder is designed to operate under specific conditions. If you need more information, refer to the product specification sheet.

2.3.2 External dimensions and cut-out

Prepare panel cut-out as detailed below:

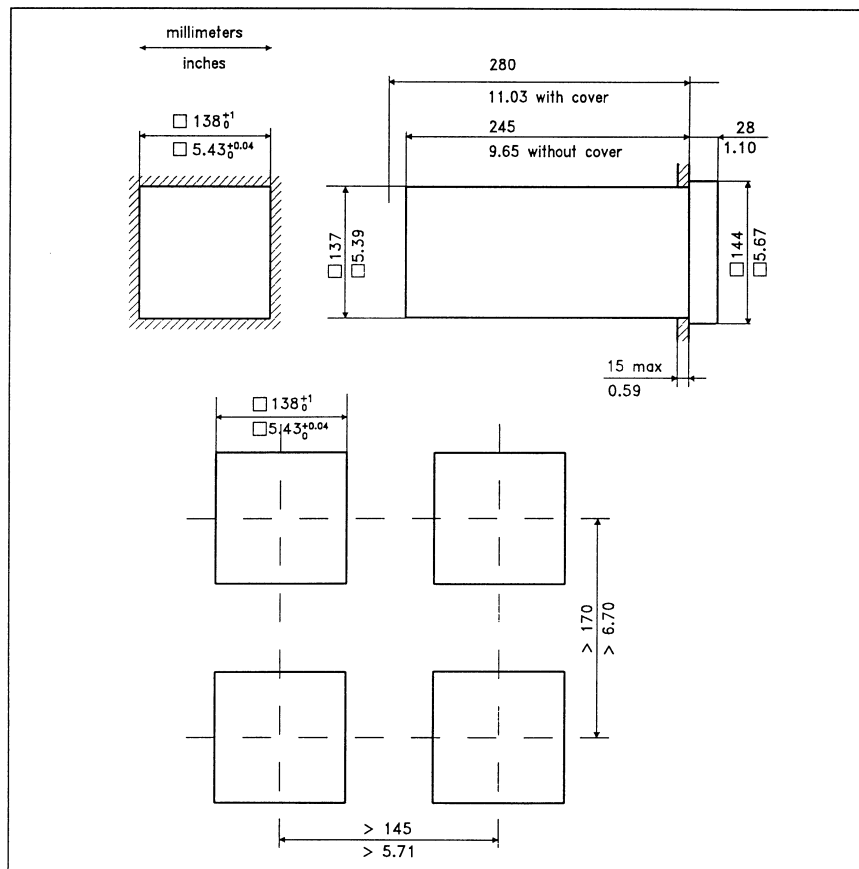

Note: Maximum panel thickness 15 mm



CAUTION

The maximum temperature inside the cabinet should not exceed the ambient conditions specific to the recorders. The recorder must be mounted into a panel to limit operator access to the rear terminals.

Failure to comply with these instructions may result in product damage

2. INSTALLATION

2.3.3 Installing the recorder

To install the recorder, follow the figures below:

Mounting brackets

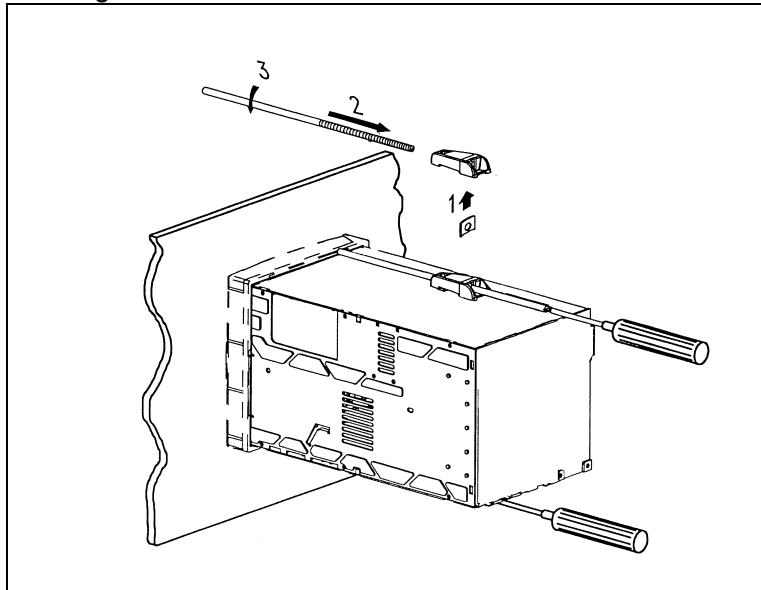

Mounting angle limits

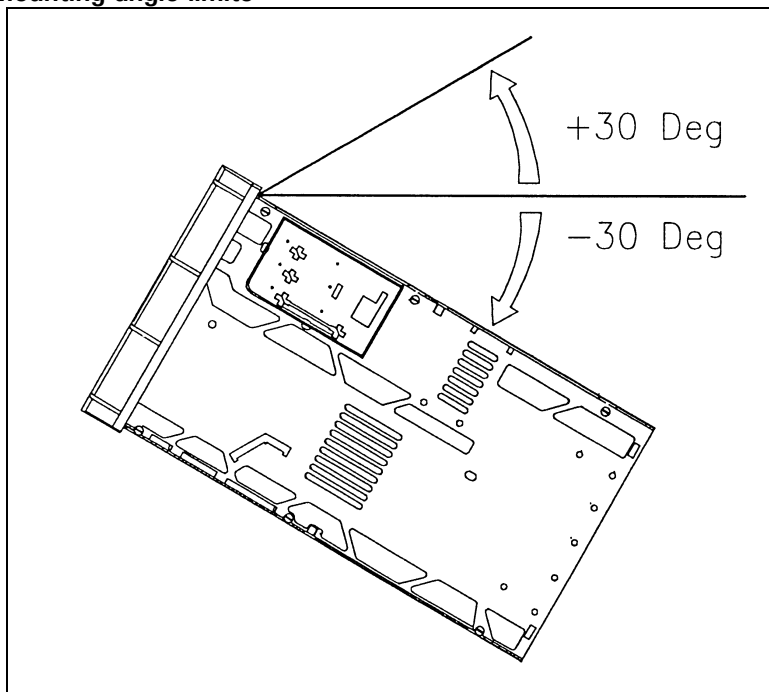

2. INSTALLATION

2.4 WIRING THE RECORDER

2.4.1 Recommendations

- All wiring must be in accordance with local norms and carried out by authorized experienced personnel.
- **The ground terminal must be connected before any other wiring (and disconnected last).**
- **A switch in the main supply is required near the equipment.**
- **If an external fuse is used to protect the line supply to the recorder, the fuse should match the recorder fuse rating (fuse type) as well as for the fuseholder.**
- Sensor wiring should be run as far as possible from power wiring.
- To reduce stray pick-up, we recommend the use of twisted pair sensor wiring.
- EMI effects can be further reduced by the use of shielded cable sensor wiring. The shield must be connected to the ground terminal.

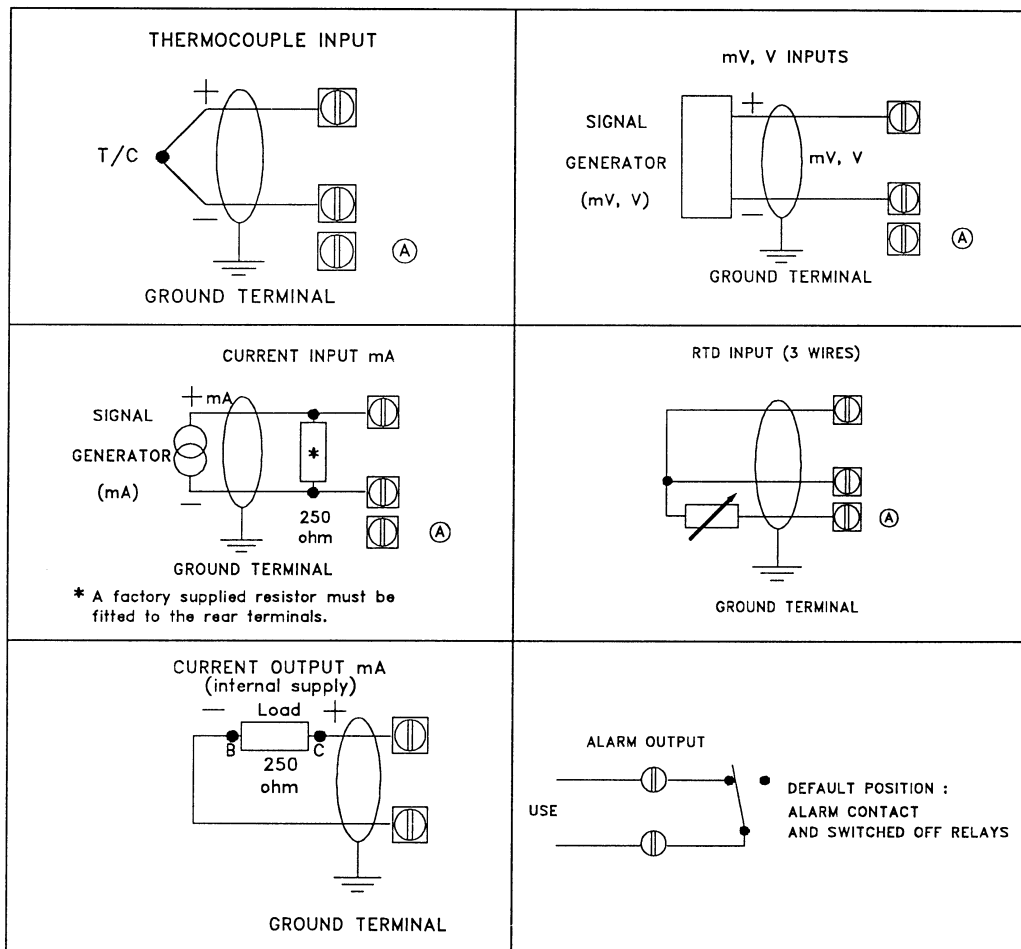

Note: Terminal (A) is only used for RTD. (See diagrams above.)

2. INSTALLATION

2.5 TERMINAL CONNECTIONS

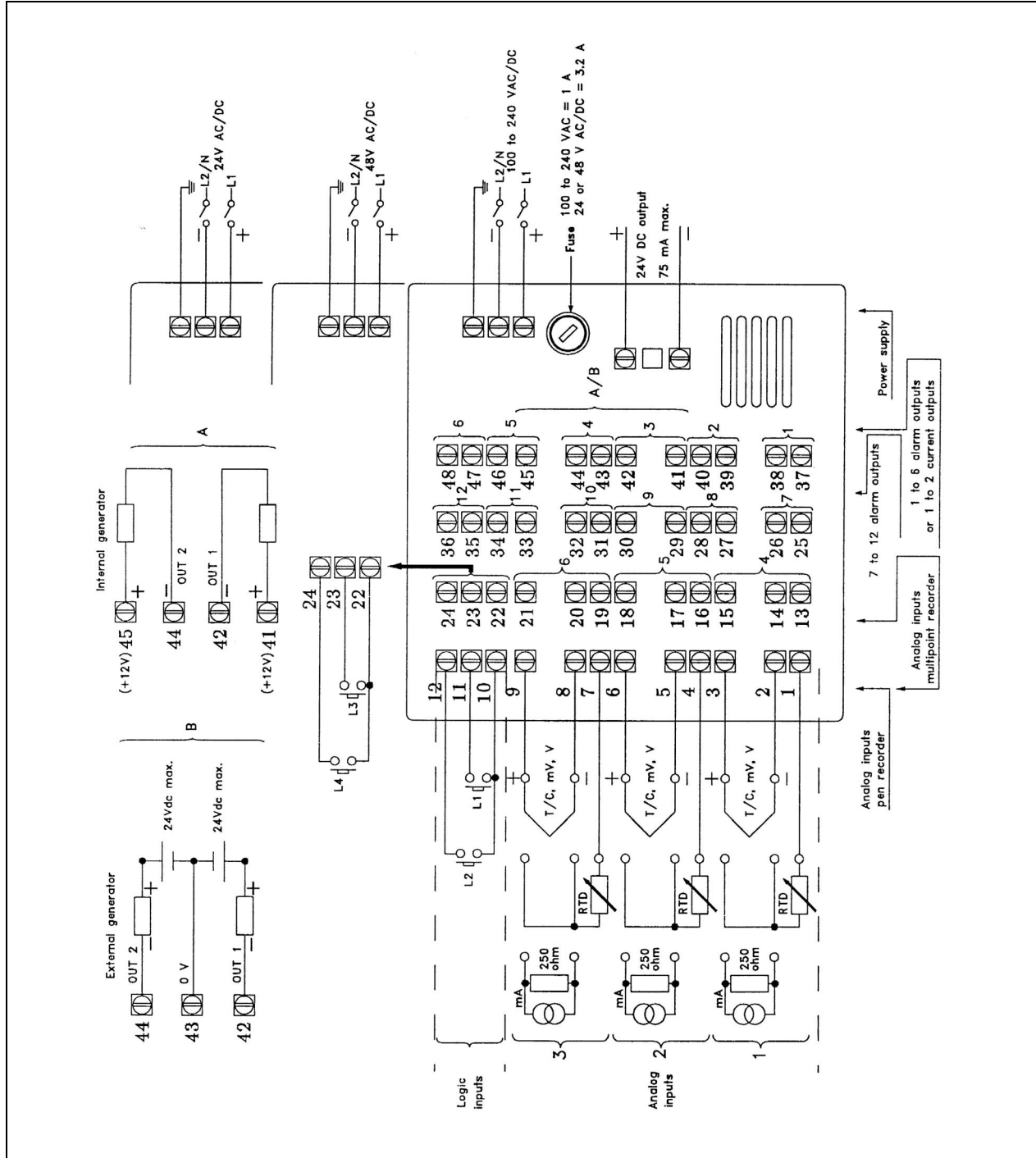

2. INSTALLATION

2.6 FITTING THE CHART

2.6.1 Roll chart

Open the chart cassette as shown below and install the chart using the figure on the cassette.

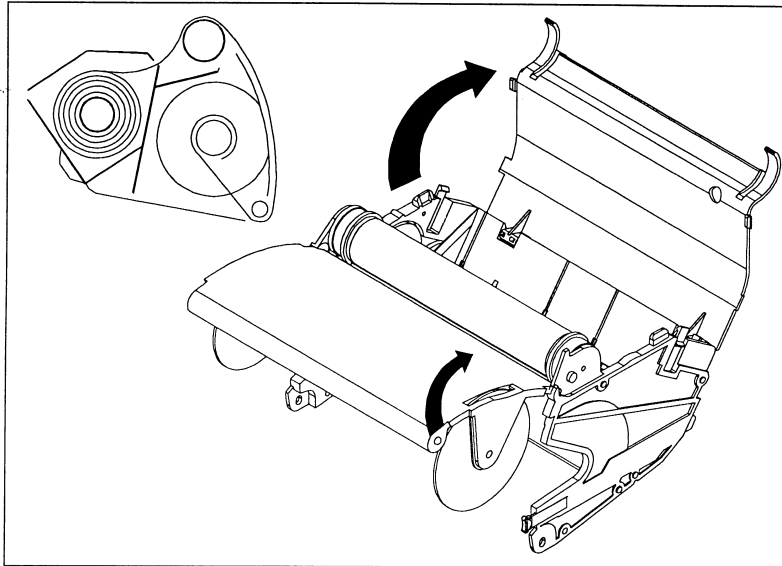



Note 1: To maintain print quality, the print carriage guide rods should be cleaned at six-monthly intervals with a dry cotton cloth. Lubrificant should NOT be used.
If required, the chart cassette can be cleaned with a damp cotton cloth.

Note 2: After the installation of a new chart, close the display and reinsert the chart cassette.

NOTICE

Reset the paper length if configured after installing the new chart. See paragraph 3.2.1 "Operators keys".

"END PAPER" message: When you see " END PAPER " message on the display ("end of paper" message), the recorder informs you that the chart arrives at the end.

To remove this message, press  until you read "PAPLG=..." (paper length) and press .

After that, the " END PAPER " message disappears.

2. INSTALLATION

2.6.2 Fanfold chart

- Open the chart cassette as shown below and install the chart using the figure on the cassette.
- Place the fanfold chart in the upper compartment with the folds in the vertical plane and the slots on the right hand side.
- Pull out 4 folds of paper and then close the rear metal cover.

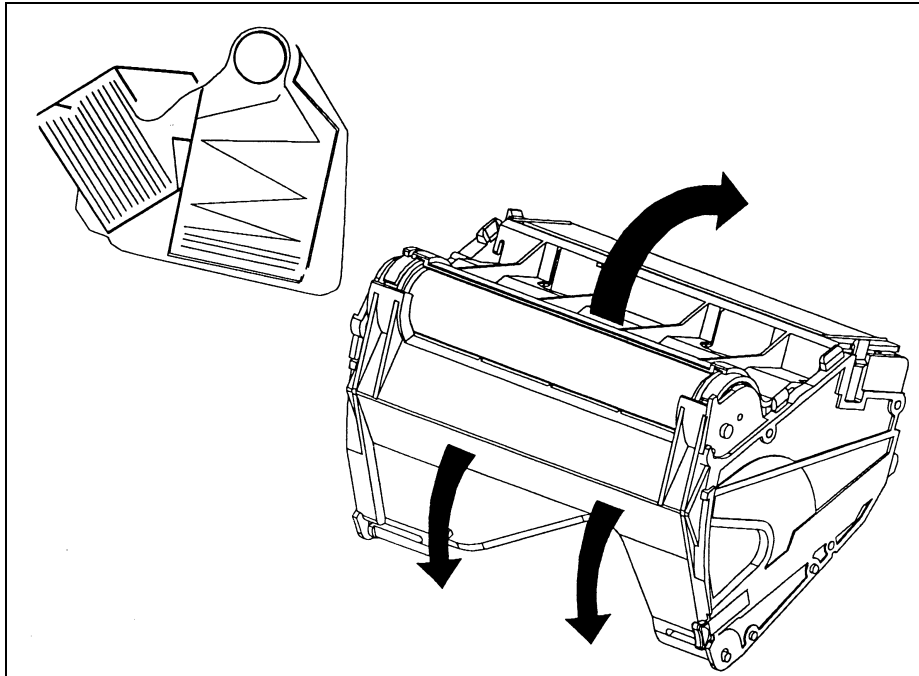



Note 1: To maintain print quality, the print carriage guide rods should be cleaned at six-monthly intervals with a dry cotton cloth. Lubricant should NOT be used. If required, the chart cassette can be cleaned with a damp cotton cloth.

Note 2: After the installation of a new chart, close the display and reinsert the chart cassette.

NOTICE

Reset the paper length if configured after installing the new chart.
See paragraph 3.2.1 "Operators keys".

"END PAPER" message: When you see " END PAPER " message on the display ("end of paper" message), the recorder informs you that the chart arrives at the end.

To remove this message, press  until you read "PAPLG=..." (paper length) and press .

After that, the " END PAPER " message disappears.

2.7 INSTALLING THE PRINTING SYSTEM

Remove the chart cassette from the chassis as shown below:

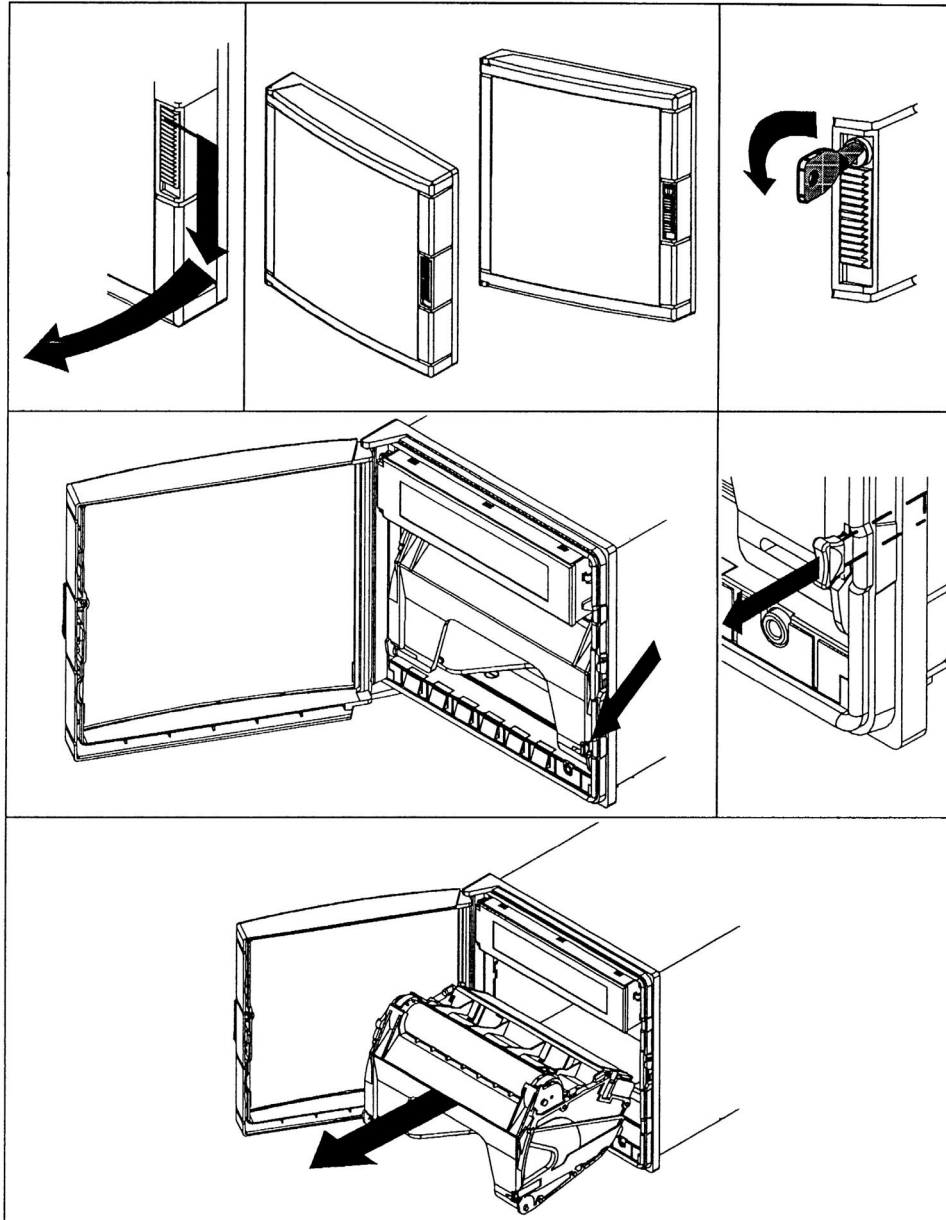

2. INSTALLATION

If you have a pen recorder, proceed as shown below:

Open the front display after having removed the chart cassette.

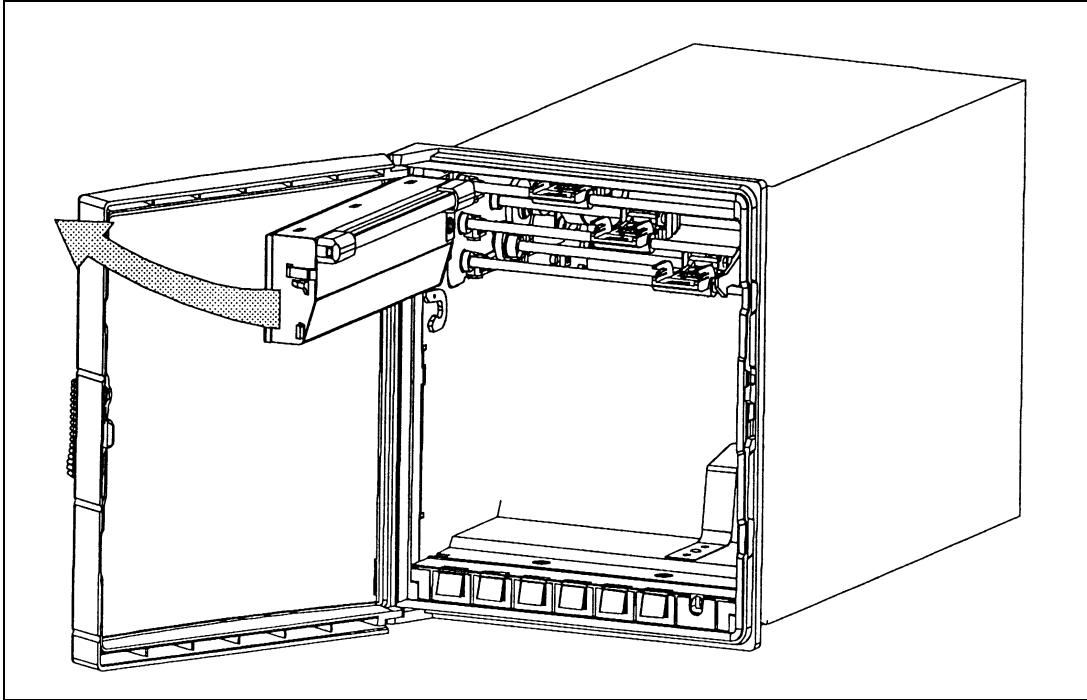

Insert the pen cartridges.

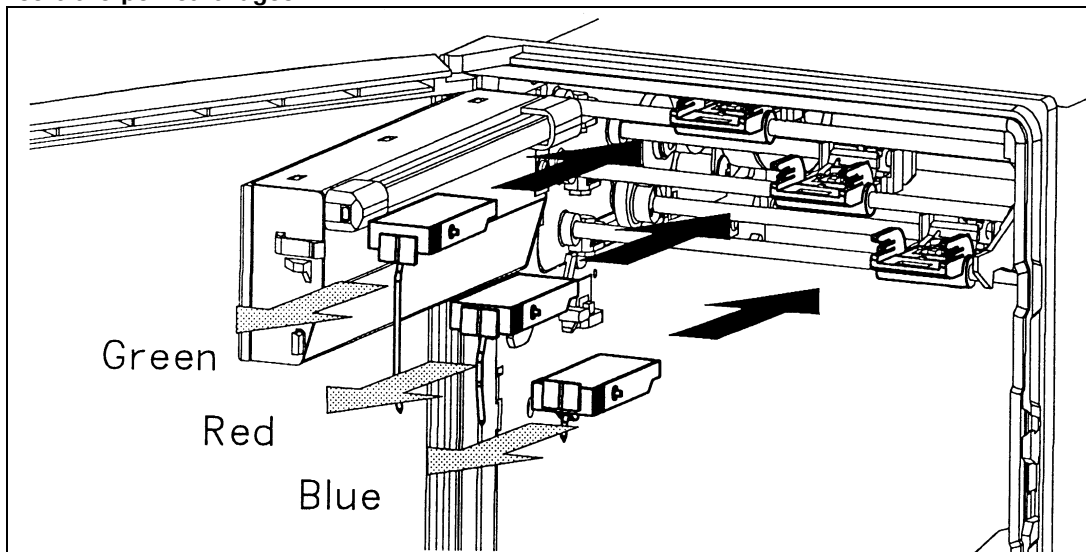

2. INSTALLATION

Inserted pen cartridges

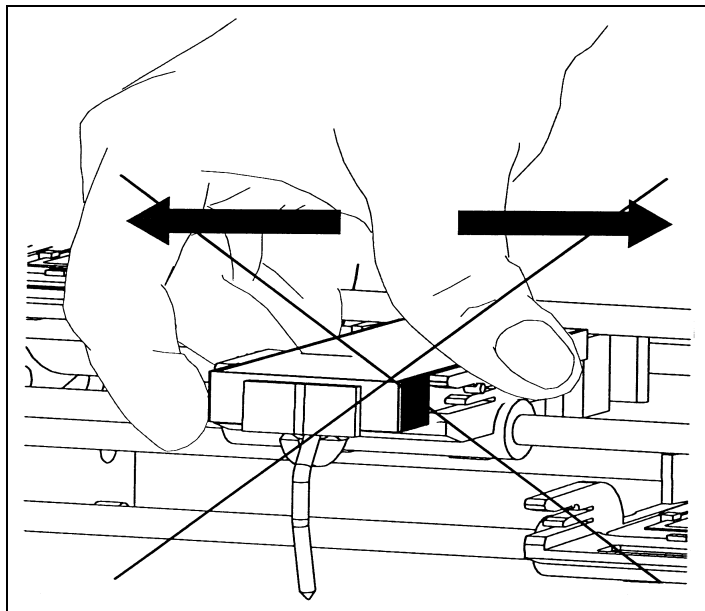
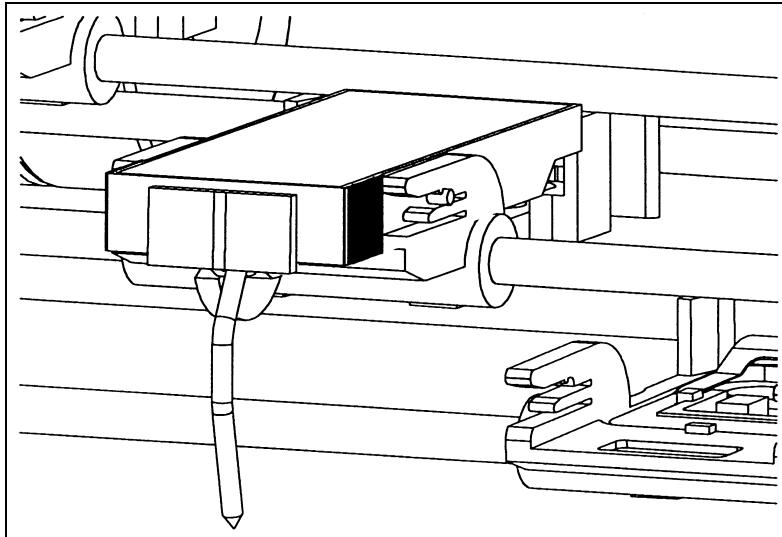

CAUTION

Do not move the print head mechanism when the recorder is working.

Failure to comply with these instructions may result in product damage

2. INSTALLATION

If you have a multipoint recorder, proceed as shown below:

Open the display after having removed the chart cassette.

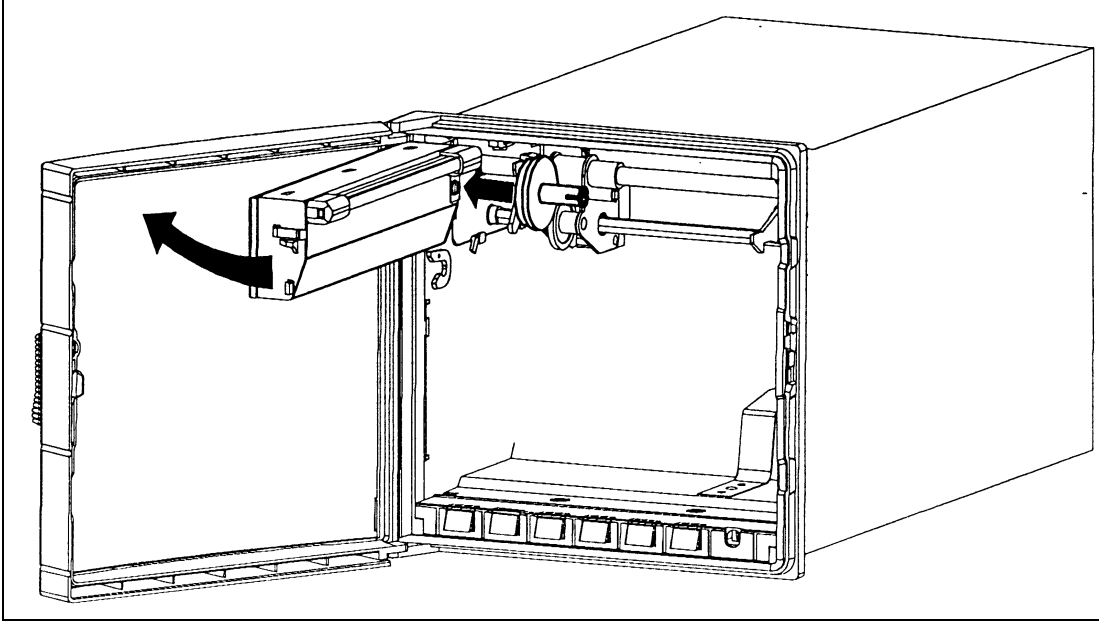

Insert the ink wheel.

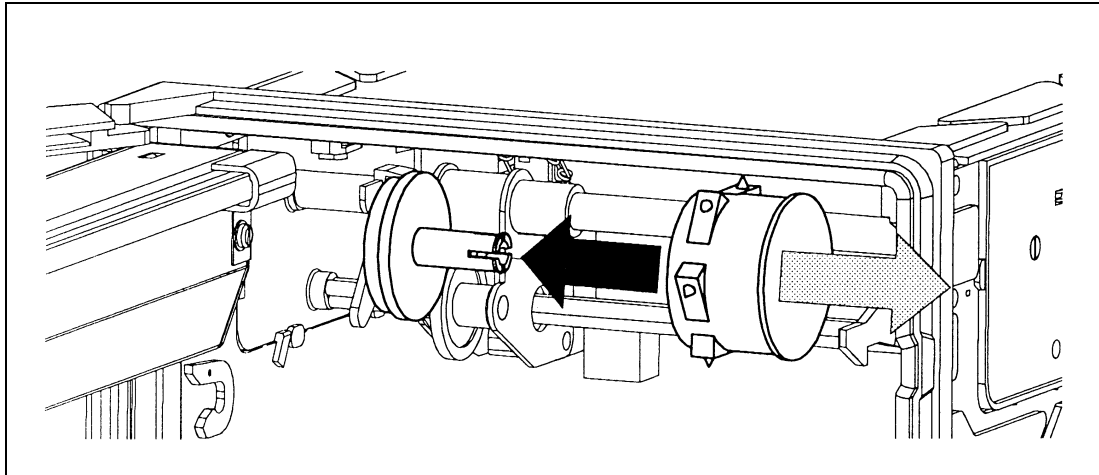

Note: The ink wheel should be inserted and rotated counter-clockwise until ratchet engages.

2. INSTALLATION

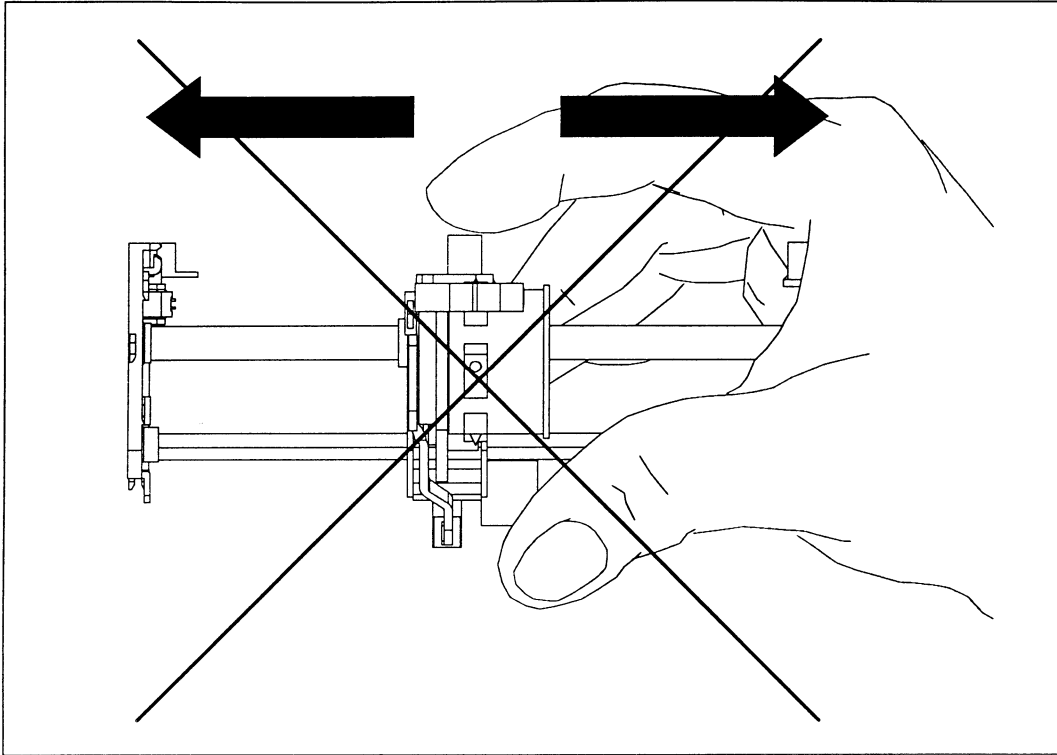

CAUTION

Do not move the print head mechanism when the recorder is working.

Failure to comply with these instructions may result in product damage

NOTE: After each change of chart, it is recommended to make a calibration again.
(See 0% and 100% CHART.)

2. INSTALLATION

<i>FUNCTION</i>	<i>TYPE OF SERVICE</i>
PRINTER	0% CHART
DEFINITION:	Chart certification to show the current 0% chart position with 0% print carriage. This is a mechanical adjustment.
HOW TO USE/EXECUTE IT:	<p>The message "(channel nb) CAL 0%" with a flashing number. This number corresponds to the present adjustment (= step motor).</p> <p>To move to the right, increase this number or to the left, decrease the number. (You may introduce a negative number.)</p> <p>You can change the distance value by pressing the ▲ ▼ keys.</p> <p>You accept the value by pressing <input type="text" value="ENTER"/>.</p> <p>You can leave the 0% chart service by pressing <input type="text" value="SETUP"/>.</p>
NOTE:	When you press <input type="text" value="ENTER"/> , the head moves and prints at the new 0% chart calibration.

<i>FUNCTION</i>	<i>TYPE OF SERVICE</i>
PRINTER	100% CHART
DEFINITION:	Chart certification to show the current 100% chart position with 100% print carriage. This is a mechanical adjustment.
HOW TO USE/EXECUTE IT:	<p>The message "(channel nb) CAL 100%" with a flashing number. This number corresponds to the present adjustment (= step motor).</p> <p>To move to the right, increase this number or to the left, decrease the number. (You may introduce a negative number.)</p> <p>You can change the distance value by pressing the ▲ ▼ keys.</p> <p>You accept the value by pressing <input type="text" value="ENTER"/>.</p> <p>You can leave the 100% chart service by pressing <input type="text" value="SETUP"/>.</p>
NOTE:	When you press <input type="text" value="ENTER"/> , the head moves and prints at the new 100% chart calibration.

2.8 CHECK LIST

- 1** Have you connected the ground terminal ?
- 2** Have you connected the sensor(s) correctly ? (Wire type, polarity, etc.)
- 3** Have you tightened all terminal screws ?
- 4** Have you installed the ink cartridge(s) or wheel ?
(See figures on pages 2-10 to 2-15.)
- 5** Have you installed the chart correctly ?
(See figures on pages 2-8 and 2-9.)
- 6** Have you closed the display ?
- 7** Have you fitted the chart cassette in the recorder ?

3.1 OPERATOR INTERFACE EXPLANATION

The operator interface comprises the display and keypad.

DISPLAY

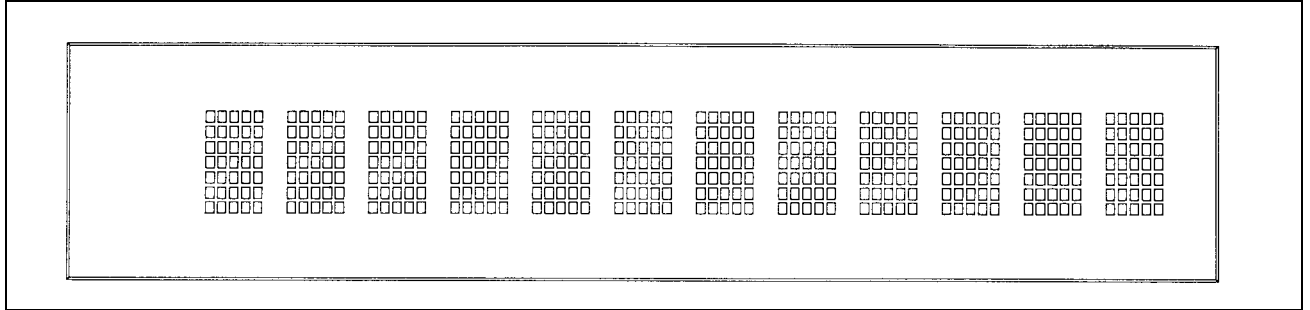

The display gives a clear indication of action prompts by means of one line of 12 characters.

KEYPAD

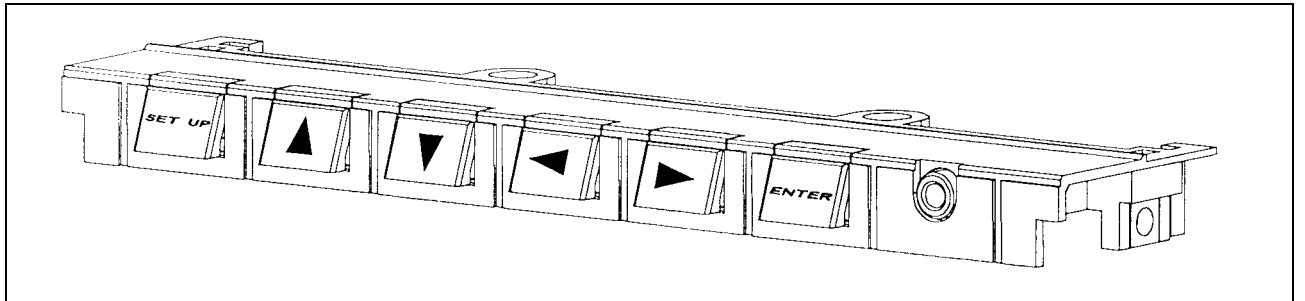

The keypad consists of 6 keys:

The **SETUP** key allows you to escape from any action menu and return to normal operating mode.





- **▲** allows you to HOLD or SCAN the channel display.
- **▼** allows you to select the DISPLAY TYPE desired.
- **◀** allows you to select the PRINT action desired.
- **▶** allows you to select the MATH or BATCH action desired.

The **ENTER** key allows you to confirm your selected action.





3.2 BASIC ACTIONS

Basic actions are executed by using     keys without entering the configuration mode. No configuration parameter can be modified.





NOTE:

The    keys are enabled and the  key is disabled by the default factory configuration. See MMI sub-matrix in the "CONFIGURATION" chapter to modify the actions above.

3.2.1 Operators keys

The 4 keys     can be used as operators keys. These keys can be enabled or disabled in configuration (MMI).

The selections are:

HOLD DISPLAY 	SELECT DISPLAY TYPE 	PRINTER 	MATH/BATCH 
<ul style="list-style-type: none"> - on CH1 - on CH2 - on CH3 - on CH4 - on CH5 - on CH6 - Display scan 	<ul style="list-style-type: none"> - Analog Input - Math Res - Traces - Traces and Tag - 1 Bargraph - 2 Bargraphs - Date and Time - Speed in use - Alarm - Comm inputs*** 	<ul style="list-style-type: none"> - Print Time - Print PV Values - Chart Hold - Chg Speed - Chart Advance* - Reset Chart Length - Print Math Results ** 	<ul style="list-style-type: none"> - Reset Math 1 - Reset Math 2 - Reset Math 3 - Reset Math 4 - Reset Math 5 - Reset Math 6 - Reset All Math - Reset Batch # - Incr. Batch #

* As long as you keep  pressed, the chart advances.

** Only if the Math package is enabled.

*** Optional

Press  to confirm the choice.

3. OPERATION

3.2.2 How to select the display type

Ten display types are available:

- **ANALOG INPUTS**

Analog input numbers, measured values and temperature actuation units will be displayed.

1 I N 3 2 7 1 . ° C

IN = mnemonic for analog input

Note: For linear actuations, if the lowest or the highest values are changed, the unit is no more displayed.

- **COMMUNICATION CHANNELS**

Communication channel numbers, values will be displayed.

C 1 1 2 9 5 2 0 . 5

COM = mnemonic for communication channel

- **MATHS RESULTS**

Maths channel numbers, maths results will be displayed.

M 1 6 1 7 5 5 0 . 8

M = mnemonic for maths results

- **CHART TRACES**

Channel numbers, measured values and engineering units (configured in the CHART matrix) will be displayed.

1 3 2 7 . 2 U N I T S

If the channel is in alarm then the units

U N I T S

will be replaced by the alarm number

A L 1 2

3. OPERATION

• **TAG NAMES AND TRACES**

Channel numbers and tag names will be displayed.



then alternately channel number value and unit will be displayed.

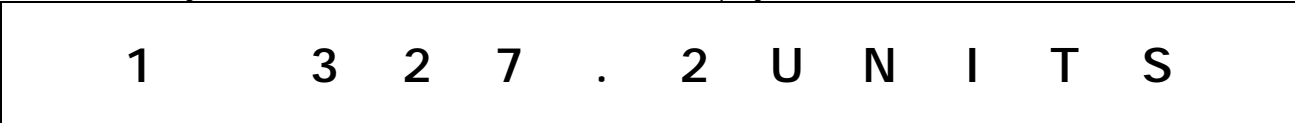

If the trace is in alarm condition then the units



will be replaced by the alarm number

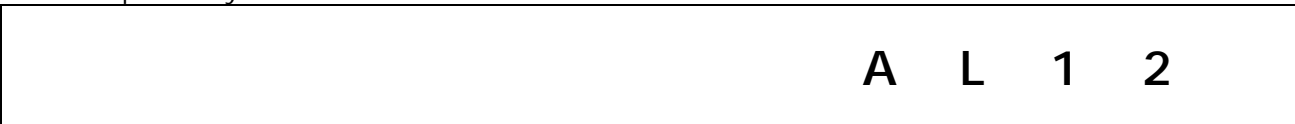

• **ONE BARGRAPH**

A channel is represented by a 20 segment bargraph.

Channel number and bargraph will be displayed.



An "A" will be displayed at the end of the bargraph if the channel is in alarm. When there is no alarm, the last digit shows the trend of the channel.

> if the values are increasing, < if the values are decreasing.

• **TWO BARGRAPHS**

(Only for 2 or 3 pen recorder)

Two channels are represented by a 2x20 segment bargraphs.



The first digit represents the channel numbers displayed by the bargraphs. ("I" means trace #1, "II" means trace #2, "III" means trace #3)

An "A" will be displayed at the end of the line if one of the channels is in alarm.

3. OPERATION

- **DATE & TIME**

Day/month, hour: min will be displayed.

3 0 / N O V 1 2 : 0 1

- **CHART SPEED**

In the trend mode number, speed number, value and unit will be displayed.

S P 1 1 2 0 0 m m / h

- **SP1 or SP2 = mnemonic for speed**

If the recorder prints in tabular format, then tabular number, tabular interval and unit will be displayed.

T A B 1 1 2 0 m i n

TAB = mnemonic for tabular interval

min = mnemonic for minute

- **ALARMS**

For each operated alarm, alarm number, alarm state, relay number and relay state will be displayed.

A L 1 1 R L 1 1 —

ON
ACTIVE

— OFF
INACTIVE

AL = mnemonic for alarm

RL = mnemonic for relay

DI = mnemonic for digital input

EV = mnemonic for event

Then alternately the time of alarm activation will be displayed. (Analog and digital alarms display)

A L 1 1 1 2 : 1 5

3. OPERATION

4. MODEL SELECTION GUIDE

4.1 PRODUCT IDENTIFICATION

Instructions

- Select the desired Key Number. The arrow to the right marks the selections available.
- Make one selection each from Tables I through VII.
- A complete Model Number must have the designated number of digits in each table.

Key Numbers	I	II	III	IV	V	VI	VII
[- - - -]	[-]	[-]	[- -]	[-]	[-]	[-]	[- - - -]
	VIII	IX					
	[- -]	[- -]					

KEY NUMBER (Note 1)	Description	Selection	Availability					
	1 Pen Recorder	DP101	↓					
	2 Pen Recorder	DP102		↓				
	3 Pen Recorder	DP103			↓			
	3 Channel Recorder	DM103				↓		
	6 Channel Recorder	DM106					↓	

TABLE I - MATH FUNCTION (Note 2)

Standard - Channel Difference, Square Root	0	•	•	•	•	•
Math Package 1: Add, Multiply, Divide	1	•	•	•	•	•
Math Package 2: Pack. 1 + Fo., Group Average, Totalizer, Gas/Liquid Mass Flow	2	•	•	•	•	•
Math Package 3: Pack. 2 + Integ., Group Max, Min, Max-Min, Steam Flow Totalization, Energy Consumption	3	•	•	•	•	•
Math Package 4: Pack. 3 + RH, 10 ^X , Envelope, Timers, Carbon Potential	4	•	•	•	•	•

TABLE II - VOLTAGE (Note 3)

85 to 264 Vac/dc 50 Hz Chart speed mm/hr	A	d	d	d	d	d
85 to 250 Vac/dc 60 Hz Chart speed inch/hr	B	•	•	•	•	•
24 Volt ac/dc 50 Hz Chart speed mm/hr	E	•	•	•	•	•
24 Volt ac/dc 60 Hz Chart speed inch/hr	F	•	•	•	•	•
48 Volt ac/dc 50 Hz Chart speed mm/hr	G	•	•	•	•	•
48 Volt ac/dc 60 Hz Chart speed inch/hr	H	•	•	•	•	•

4. MODEL SELECTION GUIDE

		D P 1 0	D P 1 0	D P 1 0	D M 1 0	D M 1 0
		1	2	3	3	6
TABLE III- OUTPUTS		Selection				
None	0_	•	•	•	•	•
Universal Communication Option RS422/485 Modbus RTU, RS422/485 ASCII, RS232/V24 ASCII (Modem)	1_	•	•	•	•	•
2 4-20 mA Auxiliary Outputs	2_	•	•	•	•	•
2 4-20 mA Auxiliary Outputs plus Universal Communications Option	3_	e	e	e	e	e
Alarm Relays: None	_0	•	•	•	•	•
6 Alarm Output	_A	•	•	•	•	•
12 Alarm Output	_B	f	f	f	f	f
2 Alarm Output	_C	•	•	•	•	•

TABLE IV - LOGIC INPUTS

None	0	•	•	•	•	•
2 Remote Contacts	A	•	•	•	•	•
4 Remote Contact	B	•	•	•	•	•

TABLE V - CHART CASSETTE

Fan Fold	Z	g	g	g	g	g
Roll	R	•	•	•	•	•

TABLE VI - DOOR AND CASE

Dark Gray Door, Plastic Window with Latch	1	•	•	•	•	•
Dark Gray Door, Plastic Window, Key Lock	2	•	•	•	•	•
Portable Case (Note 4)	5	•	•	•	•	•
Protective Case (Note 7)	6	•	•	•	•	•

4. MODEL SELECTION GUIDE

TABLE VII - OPTIONS

None	0 _ _ _ _	•	•	•	•	•
Power Supply for Transmitter 24 Vdc (50 mA max)	B _ _ _ _	•	•	•	•	•
None	_ 0 _ _ _	•	•	•	•	•
Rear Terminal Cover (Note 5)	_ G _ _ _	•	•	•	•	•
None	_ _ 0 _ _	•	•	•	•	•
UL/CSA Approved	_ _ C _ _	c	c	c	c	c
None	_ _ _ 0 _	•	•	•	•	•
Additional 3 Inputs for Math Use	_ _ _ A _	•	•	•		
None	_ _ _ _ 0	•	•	•	•	•
Certificate of Conformance (F2474)	_ _ _ _ B	•	•	•	•	•
Certificate of Calibration (F3399) (Note 8)	_ _ _ _ C	•	•	•	•	•
Certificate of Conformance & User Actuation (Note 6)	_ _ _ _ D	•	•	•	•	•
Certificate of Cal + Config & User Actuation (Note 6 & 8)	_ _ _ _ E	•	•	•	•	•
User Actuation Configuration (Note 6)	_ _ _ _ K	•	•	•	•	•
Configuration to customer requirement (Note 8)	_ _ _ _ L	•	•	•	•	•

		D	D	D	D	D
		P	P	P	M	M
		1	1	1	1	1
		0	0	0	0	0
TABLE VIII - SPECIALS	Selection	1	2	3	3	6
None	000	•	•	•	•	•
ST Number (Consult Honeywell representative or IM&C Marketing)	XXX	•	•	•	•	•

TABLE IX - Manuals

English Operator Manual and Prompts	E _	•	•	•	•	•
French Operator Manual and Prompts	F _	•	•	•	•	•
German Operator Manual and Prompts	G _	•	•	•	•	•
Italian Operator Manual and Prompts	I _	•	•	•	•	•
Spanish Operator Manual and Prompts	S _	•	•	•	•	•
Swedish Operator Manual and Prompts	W _	•	•	•	•	•
English, U.S. Format, Product Manual and Prompts	U _	•	•	•	•	•
None	_ 0	•	•	•	•	•
English Product Manual	_ 1	•	•	•	•	•
French Product Manual	_ 3	•	•	•	•	•
German Product Manual	_ 4	•	•	•	•	•

4. MODEL SELECTION GUIDE

- Note 1: The units are built with universal input and are delivered with 250 ohm resistors to convert input current signal 4 to 20 mA into 1 to 5 Volt dc (or 0 to 5 Vdc). These are packed in the product accessories.
- Note 2: Models DP1XX Pen units supplied with 3 analog inputs when Math Option is ordered. Additional 3 inputs can be selected by specifying Table VII, Option XXXAX.
- Note 3: The chart speed and frequency can be modified on the unit from key pad.
- Note 4: Portable case supplied with dark gray door, plastic window, latch, rear main switch and IEC main plug connector.
- Note 5: Rear cover is used to cover field wiring, this is in addition to the cover on the power supply terminals which is standard.
- Note 6: User defined actuation worksheets need to be completed and supplied with the order.
- Note 7: Supplied with metal sleeve, used on portable case option, no rear main switch or IEC main power plug connector supplied.
- Note 8: Customer must supply Input Actuation Type and Range for each input in the Free Form section of the order for the factory to supply the Custom Calibration Test Report (F3399).

RESTRICTIONS

Restriction Letter	Available Only With		Not Available With	
	Table	Selection	Table	Selection
c			VI	5, 6
d			VII	__ C __
e			III	_ A, _ B, _ C
f			III	1 _, 2 _, 3 _
g	50 °C Maximum temperature limit			

4. MODEL SELECTION GUIDE

USER DEFINED ACTUATION DPR100C/D

Fax to your Honeywell Customer Service

CUSTOMER ORDER No. _____

SALES ORDER No. _____

TYPE OF ACTUATION - T/C _____ LINEAR (mV) _____ Ma _____ V _____ RTD _____ (Check one)

If thermocouple - complete table for Recorder Operating Temperature for Cold Junction Compensation

Actuation 1	Cold Junc. Value	Eng. Unit Deg. C	Electrical Value (mV)
	Lowest		
	Average		
	Highest		

Actuation 2	Cold Junc. Value	Eng. Unit Deg. C	Electrical Value (mV)
	Lowest		
	Average		
	Highest		

USER DEFINED ACTUATION TABLE 1

Enter values for custom actuation (max 50 SEGMENTS)

Segment Number	ENG VALUE	Electrical VALUE	Segment Number	ENG VALUE	Electrical VALUE	Segment Number	ENG VALUE	Electrical VALUE
1			18			35		
2			19			36		
3			20			37		
4			21			38		
5			22			39		
6			23			40		
7			24			41		
8			25			42		
9			26			43		
10			27			44		
11			28			45		
12			29			46		
13			30			47		
14			31			48		
15			32			49		
16			33			50		
17			34			51		

4. MODEL SELECTION GUIDE

USER DEFINED ACTUATION TABLE 2

Enter values for custom actuation (max 50 SEGMENTS)

Segment Number	ENG VALUE	Electrical VALUE	Segment Number	ENG VALUE	Electrical VALUE	Segment Number	ENG VALUE	Electrical VALUE
1			18			35		
2			19			36		
3			20			37		
4			21			38		
5			22			39		
6			23			40		
7			24			41		
8			25			42		
9			26			43		
10			27			44		
11			28			45		
12			29			46		
13			30			47		
14			31			48		
15			32			49		
16			33			50		
17			34			51		

5. PRODUCT SPECIFICATION SHEET

Technical data	
Technology	Microprocessor based, with non-volatile memory. Flash memory for software upgrade via the front jack.
Analog inputs	
Pen recorder	1, 2 or 3 continuous traces
Multipoint recorder	3 or 6 channels inputs are scanned by solid state switches and are galvanically isolated, except for RTD sensors.
Signal source	Thermocouple with individual cold junction compensation. Line resistance up to 1000 ohms T/C, mV, mA, V RTD Pt 100 3-wire connections, lead resistance per wire 40 Ω balanced.
Basic mathematic functions	Square Root extraction ($\sqrt{\quad}$) ; Differential = (ΔT)
Filter	A digital filter is configurable per input, 0 to 99 seconds.
Field calibration	A channel field calibration - 0% and 100% span - may be made to certify input sensor loop.
Burnout	T/C, mV, Volt, configurable to upscale, to downscale or none. RTD: inherent upscale. mA: inherent downscale
Scanning time (solid state relays)	Pen: 1 pen = 160 ms 2 pens = 240 ms 3 pens = 330 ms Multipoint: 3 channels = 330 ms 6 channels = 640 ms
Input impedance	10 Mohm for T/C, mV inputs, > 1 Mohm for volt inputs.
Stray rejection	Series mode \geq 60 dB. Common mode at 250 Vac \geq 130 dB.
Display	12 digit fluorescent display: 8.5 mm high (function display) configurable in: - digital PV values with engineering unit in accordance with the input range - 1 or 2 bargraphs Can display analog input, tags, maths results, communication, alarms or event messages.
Brightness	The display brightness is configurable.
Recording span	
Scaling	Per input, up to 2 analog scales can be configured to be printed on the chart with the engineering unit, channel reference and tag name. Each input can be configured differently.
Zoning	Each input can be configured on 0 to 100%, or 0 to 50%, or 50 to 100% of the chart.
Pen offset (Pen recorder)	Distance between pen: 2 mm - Offset compensation configurable. Chart definition: 1 step = 0.2 mm
Pen carriage speed	1 second full scale

5. PRODUCT SPECIFICATION SHEET

Technical data	
Chart length	Fanfold 18 m (as DIN 16230) Roll 24 m
Pen trace	
Pen	1400 m per pen
Multipoint	250 m per color
Chart speed	1 or 2 chart speeds, fully configurable, selected by a logic input, alarm or configuration. Speed 1: fully adjustable per step of 1 mm/h, within limit Speed 2: fully adjustable per step of 1 mm/h, within limit
Speed setting	Pen: 1 to 6000 mm/h (0.04 to 240 inch/h). Mpt: 1 to 1500 mm/h (0.04 to 60 inch/h) Continuous traces in color, dotted traces in configurable color with regular chart documentation (configurable).
Stepping chart motor	Resolution 0.12 mm
Product configuration	
Front configuration	- 2 product configurations can be stored and selected by the front keys. - A very simple and interactive product configuration can be carried out on the product with 6 front keys. A friendly program with prompt messages confirms the operation. The prompt messages can be selected in the different languages: English, German, French, Spanish, Italian or Swedish. A 2-level password protects the unit from non-authorized modification (level 1 = limited access ; level 2 = full protection)
PC configuration	Through the front jack the unit can be configured from a PC through a PC interface. This provides the facility to copy the configuration, modify, store, upload or download the product configuration or make a service diagnostic, or upgrade a new software or linearize 2 special customer sensors. (50 segments each).
Logic inputs	
Actions	Up to 4 dry contact inputs (1.5 mA, 12 Vdc) Change chart speed 1 to speed 2, tab interval 1 to tab interval 2, digital print-out, print message, print inhibit, event trace, print a batch message, tabulate maths calculations. Event marking: Pen: Pen 1 used as operation marker on the right side of the chart for event 1 and on the left side of the chart for event 2. Mpt: 4 traces maximum on the chart. The trace position and the color are configurable.
Alarms	
Setpoint	12 alarm setpoints, freely assignable to any channel and output relay. Full configurability of setpoint, hysteresis and alarm type (high, low rate of change, deviation).
Function	Can trigger a message, print channel red in alarm, print in alarm, change the range, change the speed, print digital PV values, trigger the event precursor.
Output	2, 6 or 12 SPST relay outputs: 2 A, 250 Vac on resistive load. Contact N.C. in alarm condition (configurable in N.O.)

5. PRODUCT SPECIFICATION SHEET

Technical data	
Alphanumeric documentation	
Messages	12 freely assignable and configurable messages of 14 characters each, including the specific German and Swedish letters. Can be printed with the date/time on top of the traces by alarms, logic inputs or communication.
Batch header	One batch message of 4 lines of 14 characters, fully configurable, with incremented batch numbers and date/time. Printed through digital input and saved upon power interruption.
Process variable	The traces can be assigned to analog input, mathematics calculations or communication inputs, and are printed in channel color. Periodic digital printing at time intervals configurable from 1 to 1440 minutes. Digital print-out of PV values through alarms, digital inputs, communication or front keyboard.
Tag name	Each channel can be named by 8 characters
Event precursor	
Stand-by	The acquisition data is stored in a buffer memory. (FiFo) A stand-by message is periodically printed.
Downloading	On event (alarm, digital input, front key, communication) the data is downloaded to be printed on the chart at pre-configured speed. The history before and after the event represents about 50 mm of chart paper.
Mathematics package (optional)	Many functions are available such as: <ul style="list-style-type: none"> - Energy consumption - Basic mathematics functions - Square root - Fo sterilization - Totalization - Mass flows - Vacuum pressure - Averages - Min., max. - Timers - Carbon potential The maths calculations and results are stored during power interruptions
Digital communication (optional)	
Protocols	RS232 ASCII communication to PC application. RS422 or RS485 ASCII communication output. RS422 or RS485 Modbus RTU communication output.
PC supervision	Through ASCII communication, application software gives the facility to read PV's, alarms or event status, to store the information on a file, to send a message to the recorder or to modify the product configuration.
Autodial	The RS232 ASCII communication can dial automatically a phone number of a remote station to send via modem an alarm message or a periodic report. Use of this feature can cause communications conflicts if data acquisition software attempts to communicate with the recorder at the same time. During an Autodial the recorder becomes the master on the communications link.
Event	The recorder can be configured to deliver an output signal (alarm relay) on a recorder event such as burnout, paper cassette out, battery fail, alarm condition, communication interrupted.

5. PRODUCT SPECIFICATION SHEET

Technical data	
Current output (optional)	2 current output, signals 4 to 20 mA reference conditions. Configurable on analog inputs, mathematic calculations, communication signals. Accuracy 0.1% reference conditions. (Add measure accuracy for analog outputs.) Temperature drift of 0.1% per 10° C in the rated limits. (0 to 50° C ; 85 to 264 V). Voltage supplied by the recorder: + 12 V with a max. resistance load of 400 ohms. Or External supply voltage: ≤ 24 V with a max. resistance load such as $(V_{ext} - 12) / 0.02 \leq R \leq (V_{ext} - 4) / 0.02$
Power supply To transmitters Power consumption Supply voltage Frequency range Power	85 to 264 Vac 50 Hz or 24 or 48 Vac/dc (+ 10-15% nominal) 24 V, 75 mA max. (optional) (75 mA available from 100 V) 3 pens or Mpt: 55 VA max. (active power 30 W) 100 - 240 Vac 50/60 Hz max. 55 VA
Clock timer Format Power interruption Accuracy	Year, month, hour, minute can be set. Battery backed (10 years time, 3 years off power) $\pm 10^{-5}$
Packaging Weight Front face Depth Front window Front protection Lock Construction Chart illumination Option	Pen or Mpt: 3.5 kg 144 × 144 mm according to DIN 43718 245 mm/9.7 inch behind panel, including terminals and line protection cover Polycarbonate IP 54 (IEC 529) Latch or key (DIN 43832-N) Silicon-free Fluorescent light Rear terminal cover, portable case.
Mounting	Panel mounting $\pm 30^\circ$ from horizontal
Wiring	Rear screw terminals. Terminal modules are plugged on the instrument.

5. PRODUCT SPECIFICATION SHEET

Technical data	
Writing	
Pen	1 cartridge per pen, fiber tip, 1400 m of trace per color (blue, red, green)
Multipoint	1 print wheel, 6 colors, 250 m of trace per color (purple, red, black, green, blue, brown).
Noise immunity	<p>This product is in conformity with the protection requirements of the following European council directives:</p> <ul style="list-style-type: none"> • 73/23/EEC – Low Voltage directive • 89/336/EEC – EMC Directive <p>Conformity of this product with any other “CE Mark” Directive(s) shall not be assumed.</p> <p>EMC Classification:</p> <ul style="list-style-type: none"> • EN 50081-2-1993 Electromagnetic Compatibility – General Emission Standard, Part 2: Industrial Environment. • EN 50082-2-1995 Electromagnetic Compatibility – General Immunity Standard, Part 2: Industrial Environment
Safety protection	Complies with IEC 61010-1 and UL 3121-1 for process control instrumentation Pollution Degree 2, Installation category II.
Electrical insulation	
Input to input	Test voltage 280 Vac or Vdc for 1 minute (except for RTD input)
Input to ground	Test voltage 2.1 kVdc for 1 minute
Input to line voltage	Test voltage 2.1 kVdc for 1 minute
Line voltage to ground	Test voltage 2.1 kVdc for 1 minute
Alarm relay to ground	Test voltage 2.1 kVdc for 1 minute
Logic input to ground	Test voltage 500 Vdc for 1 minute
Temperature	
Ambient	0 to 50° C (32 to 122° F) for Fan Fold 0 to 60° C (32 to 140° F) for Roll Chart
Storage	-40 to 70° C (-40 to 158° F)
Humidity	
Roll	10 to 90% RH non-condensing
Fanfold	15 to 80% RH non-condensing
Vibrations	<p>Frequency:</p> <p>10 to 60 Hz, amplitude 0.07 mm</p> <p>60 to 150 Hz, acceleration 1 g</p>

5. PRODUCT SPECIFICATION SHEET

Technical data																								
Reference conditions																								
Temperature	23° C ± 2° C (73° F ± 3° F)																							
Humidity	65% RH ± 5% RH																							
Line voltage nominal	± 1 %																							
Source resistance	0 Ω																							
Series mode	0 V																							
Common mode	0 V																							
Frequency nominal	± 1 %																							
Accuracy	Accuracy of displayed values: 0.1 % of the selected input range * (IEC 873) For a 4/20 mA input, you must add the resistor accuracy. Cold junction accuracy: 0.5° C Chart resolution: 0.2 m																							
Rated limits and associated drifts	<table style="width: 100%; border-collapse: collapse;"> <thead> <tr> <th style="text-align: left; width: 30%;">Parameter</th> <th style="text-align: left; width: 30%;">Rated limits</th> <th style="text-align: left; width: 40%;">Influence on accuracy</th> </tr> </thead> <tbody> <tr> <td style="padding: 5px;">Temperature</td> <td style="padding: 5px;">0 to 50° C (32 to 122° F)</td> <td style="padding: 5px;">0.1% per 10° C of change Cold junction 0.3° C/10° C</td> </tr> <tr> <td style="padding: 5px;">Supply voltage</td> <td style="padding: 5px;">85 to 264 Vac</td> <td style="padding: 5px;">No influence</td> </tr> <tr> <td style="padding: 5px;">Source resistance</td> <td style="padding: 5px;">T/C, mV RTD</td> <td style="padding: 5px;">6 μV per 100 Ω of line resistance 1000 Ω max. 0.1° C per Ω in each wire balanced leads 40 Ω max.</td> </tr> <tr> <td style="padding: 5px;">Humidity</td> <td style="padding: 5px;">10 to 90% RH at 25° C</td> <td style="padding: 5px;">0.1% max.</td> </tr> <tr> <td style="padding: 5px;">Long-term stability</td> <td style="padding: 5px;"></td> <td style="padding: 5px;">0.1% per year</td> </tr> <tr> <td style="padding: 5px;">Vibrations</td> <td style="padding: 5px;">1.25 mm at 0 to 14 Hz 1 g at 14 to 250 Hz</td> <td style="padding: 5px;"></td> </tr> </tbody> </table>			Parameter	Rated limits	Influence on accuracy	Temperature	0 to 50° C (32 to 122° F)	0.1% per 10° C of change Cold junction 0.3° C/10° C	Supply voltage	85 to 264 Vac	No influence	Source resistance	T/C, mV RTD	6 μV per 100 Ω of line resistance 1000 Ω max. 0.1° C per Ω in each wire balanced leads 40 Ω max.	Humidity	10 to 90% RH at 25° C	0.1% max.	Long-term stability		0.1% per year	Vibrations	1.25 mm at 0 to 14 Hz 1 g at 14 to 250 Hz	
Parameter	Rated limits	Influence on accuracy																						
Temperature	0 to 50° C (32 to 122° F)	0.1% per 10° C of change Cold junction 0.3° C/10° C																						
Supply voltage	85 to 264 Vac	No influence																						
Source resistance	T/C, mV RTD	6 μV per 100 Ω of line resistance 1000 Ω max. 0.1° C per Ω in each wire balanced leads 40 Ω max.																						
Humidity	10 to 90% RH at 25° C	0.1% max.																						
Long-term stability		0.1% per year																						
Vibrations	1.25 mm at 0 to 14 Hz 1 g at 14 to 250 Hz																							
Extreme conditions																								
Operating																								
Temperature	0 to 60° C (32 to 140° F)																							
Humidity	10 to 90% RH non-condensing																							
Storage																								
Temperature	-40 to 70° C (-40 to 158° F)																							
Humidity	5 to 95% RH non-condensing																							

* Refer to "Available ranges" tables for exceptions.

5. PRODUCT SPECIFICATION SHEET

Available ranges					
Linear	RTD/OHMS		Thermocouple		
0/10 mV	Pt 100 Ω at 0° C		J -50/150° C	S 0/1600° C	U -50/150° C
-10/10 mV	IEC -50/150° C**	JIS -50/150° C**	J -58/302° F	S 32/2912° F	U -58/302° F
0/20 mV	IEC -58/302° F**	JIS -58/302° F**	J 0/400° C	S -20/1760° C	U 0/150° C
-20/20 mV	IEC 0/100° C**	JIS 0/100° C**	J 32/752° C	S -4/3200° F	U 32/302° F
0/50 mV	IEC 32/212° F**	JIS 32/212° F**	J -200/870° C		U 50/150° C
-50/50 mV	IEC 0/200° C**	JIS 0/200° C**	J -328/1598° F	N 0/400° C	U 122/302° F
10/50 mV	IEC 32/392° F**	JIS 32/392° F**		N 32/752° F	U -200/400° C
0/100 mV	IEC 0/400° C**	JIS 0/400° C**	L -50/150° C	N 0/800° C	U -328/752° F
-100/100 mV	IEC 32/752° F**	JIS 32/752° F**	L -58/302° F	N 32/1452° F	
0/500 mV	IEC -200/500° C**	JIS -200/500° C**	L 0/400° C	N 0/1200° C	NiMo 0/1400° C
-500/500 mV	IEC -328/932° F**	JIS -328/932° F**	L 32/752° F	N 32/2192° F	NiMo 32/2552° F
0/1 V			L -200/870° C	N -20/1300° C	
-1/1 V			L -328/1598° F	N -4/2372° F	W-W 26 -20/2320° C
0/2 V					W-W 26 -4/4208° F
-2/2V		Ni 50 Ω -80/320° C**			W5-W 26 -20/2320° C
0/5 V		Ni 50 Ω -112/608° F**	K 0/400° C	T -50/150° C	W5-W 26 -4/4208° F
-5/5 V		Ni 508 Ω -50/250° C**	K 32/752° F	T -58/302° F	
1/5 V		Ni 508 Ω -58/482° F**	K 0/800° C	T 0/150° C	
0/10 V		Cu 10 Ω -20/250° C**	K 32/1452° F	T 32/302° F	PR 20-40 0/1800° C
0/20 mA*		Cu 10 Ω -4/482° F**	K 0/1200° C	T 50/150° C	PR 20-40 32/3272° F
4/20 mA*		OHM 0/200	K 32/2192° F	T 122/302° F	
		OHM 0/2000	K -200/1370° C	T -200 /400° C	B 40/1820° C
			K -328/2498° F	T -328/752° F	B 104/3308° F
			R -20/1760° C		
			R -4/3200° F		

* mA inputs for 250 ohms input resistor

** Accuracy: 1° C or 1.8° F

(Accuracy: The tolerance for the resistor must be added to the specifications.)

Notes:

For non-linear temperature transmitter (1 to 5 Vdc, 4 to 20 mA, 0 to 5 Vdc, 0 to 20 mA), the transmitter range must be identical to the full actuation range of the recorder.

Provision for T/C input for remote compensation box at fixed temperature of 50° C or 60° C. When temperature is not fixed, any input can be used as remote compensation temperature measurement.

5. PRODUCT SPECIFICATION SHEET

6.1 OPERATOR INTERFACE

The operator interface comprises the display and keypad used for recorder configuration.

DISPLAY

The display gives a clear indication of the configuration prompts by means of one line of 12 characters.

KEYPAD

The keypad consists of 6 keys:

A clear understanding of keypad use is vital for any operation like Reading/Writing (R/W), Printing (PRN) or Service (SRV).

ACCESS TO CONFIGURATION







Access to Read/Write Configuration (R/W), Print Configuration (PRN) or Service (SRV) is obtained by pressing the  key.

THE PASSWORDS

To protect the recorder against unauthorized access, the operator has to enter a password. There are two possible levels of access:

- Password #1 allows limited access to configuration.
- Password #2 allows full access to Read/Write Configuration, Print Configuration or Service.

HOW TO ENTER THE PASSWORDS

- Use of   keys allows you to modify the value of one digit of the password and the   keys are used to select the different digits of the modified value.
- Press  to update your modification.
- Or Press  to exit configuration mode.

NOTE: If you lost your password, please contact your nearest service center.

6. CONFIGURATION

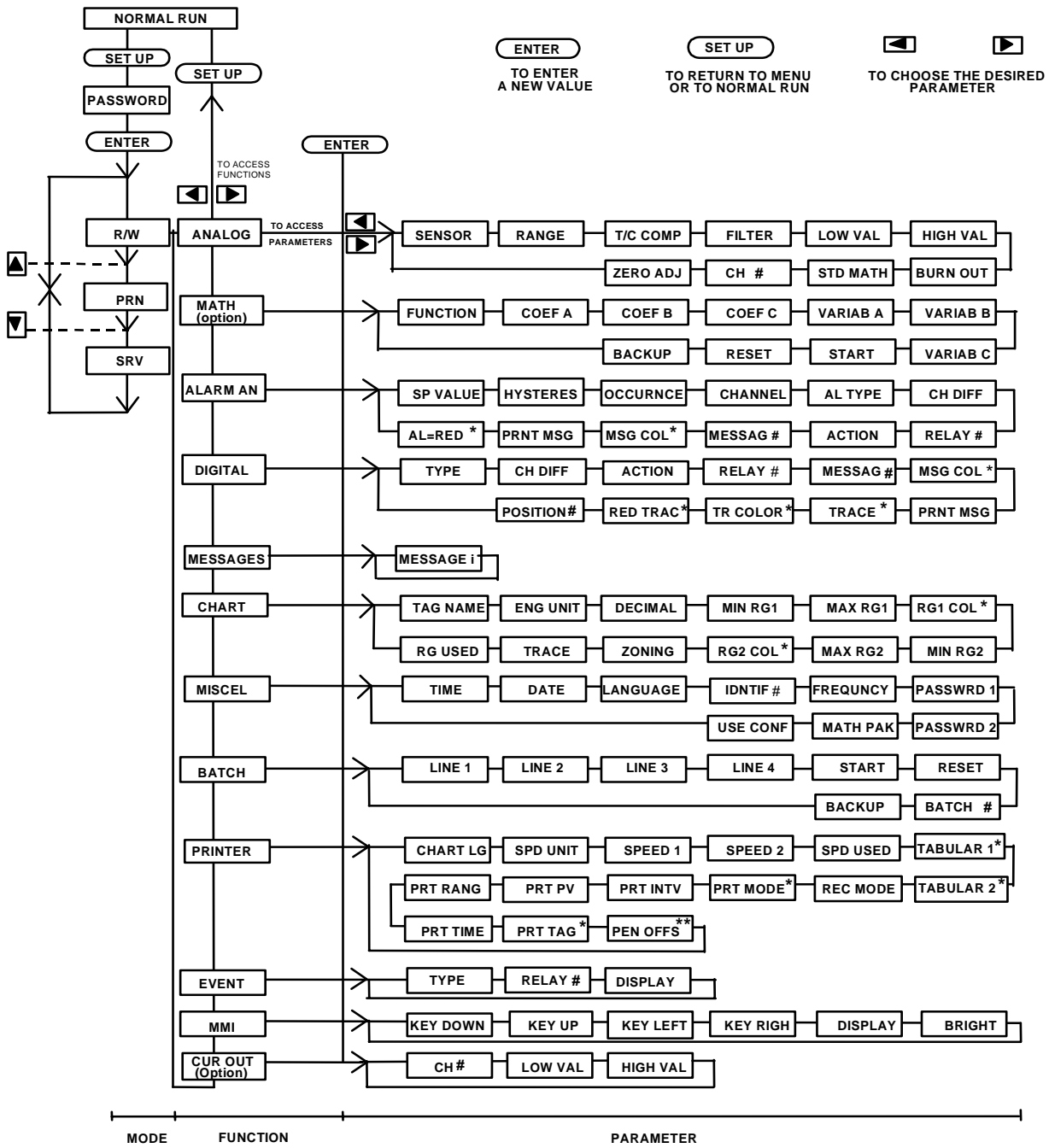

* Available on Multipoint recorders only.
 ** Available on Pen recorders only.

FUNCTION ORGANIZATION WITH PASSWORD #2

6. CONFIGURATION

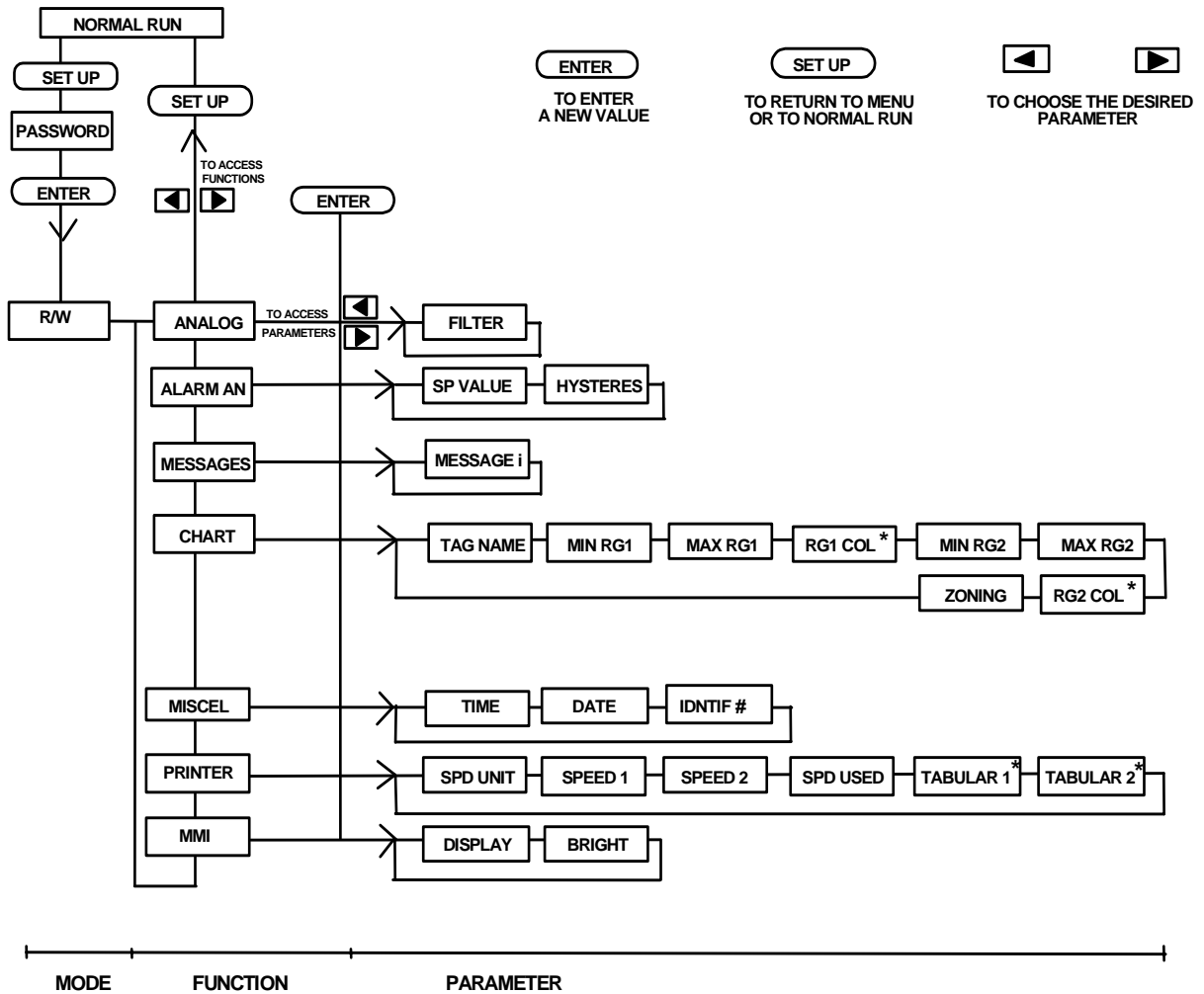



* Available on Multipoint recorders only.

FUNCTION ORGANIZATION WITH PASSWORD #1



6. CONFIGURATION

☑ READ/WRITE ACCESS TO PARAMETER VALUES

- **Parameter selection**

Use of   keys allows you to select the parameter you want to read/write.

Use of   keys allows to select the channel on which you want to read/write the parameter.

Press  to confirm your selection, or press  to return to main function.

If necessary, the recorder stops measuring and printing during configuration access. In this case, the "CONFIRM." message will be displayed. Press  to confirm or press  to escape.



- **Value of parameter**



If you leave a key for a few seconds, the recorder will display alternately the name and the current value.

- **Parameter modification**

Press  to begin the modification of parameter.
The current value blinks.

Some parameters require text selection while others require numerical values.

 and  keys permit, as applicable, the selection of desired text or increment/decrement of numerical value.

 and  keys can be used to shift the position of the digit to be changed.

Press  to confirm your change.

Or press  to come back to parameter selection.

6.2 ONE EXAMPLE: HOW TO SET THE CHART SPEED

- ☑ Press **SETUP** key.
- ☑ Enter password #1.
- ☑ Press **ENTER** .
- ☑ Use of **▲ ▼** keys allows you to select the R/W configuration mode (read/write configuration).
- ☑ Use of **◀ ▶** keys allows you to select the PRINTER function.
- ☑ Press **ENTER** to confirm your function type selection.

☑ Parameter selection

Use of **◀ ▶** keys allows you to select SPEED 1.

Press **ENTER** to confirm your selection.

Use of **▲ ▼** keys allows you to modify the value of one digit. If necessary, the **◀ ▶** keys are used to shift the position of the digit to be changed.

Press **ENTER** to confirm your modification.

Press **SETUP** to come back to main function.

Press **SETUP** to return in normal operation.

6. CONFIGURATION

6.3 PROMPTS EXPLANATION

ANALOG FUNCTION	
<i>PARAMETERS:</i>	
SENSOR	<p>Basic sensor type used on each channel. <u>Factory configuration:</u> All CH are configured in T/C, mV, V range position.</p> <div style="display: flex; justify-content: space-around; align-items: center;"> <div style="text-align: center;"> <p>SLOT 1</p> <p>Channel 3 Channel 2 Channel 1</p> <p>RTD Ranges position Thermocouple mV, V Ranges position</p> <p>BOTTOM SIDE</p> </div> <div style="text-align: center;"> <p>SLOT 2</p> <p>Channel 6 Channel 5 Channel 4</p> <p>RTD Ranges position Thermocouple mV, V Ranges position</p> <p>BOTTOM SIDE</p> </div> </div>
RANGE	<p>DISPLAY ACTUATION RANGE For directly connected temperature sensors and non-linear temperature transmitters, the actuation selection defines the linearisation routine used to produce a linear chart scale. For linear transmitters, the selection simply defines the transmitter's electrical range/span. The choice of actuation offered by the recorder during configuration will depend upon the sensor selected.</p>
T/C COMP	<p>To select the channel number to measure the temperature of a remote compensation box. This setting eliminates the variable cold junction and implements the hot box temperature. Application: To use an uncontrolled remote compensation box channel #.</p>
FILTER ♣	<p>You may wish to apply a filter to noisy signals. However if you want to display and record pulses, square waves or other rapidly changing inputs without damping, choose 0 filter value.</p>
LOW VAL	<p>Engineering value corresponding to low limit of the selected input actuation range.</p>
HIGH VAL	<p>Engineering value corresponding to high limit of the selected input actuation range</p>
BURN OUT	<p>Allows you to define the safety backup position to activate alarms (if configured) in case of sensor burnout. The trace can go either on the right (upscale) or on the left (downscale).</p>
STD MATH	<p>2 mathematical functions are included as standard in the recorder. These functions apply only to analog inputs.</p>
CH #	<p>Second channel used when OPT MATH = CH DIFF</p>
ZERO ADJ	<p>Zero adjustment means to offset/bias the calibration of the input. Otherwise choose 0 Value = Factory Calibration. Adjustments are made directly in Engineering unit. (Ex.: 5 = 5° C)</p>

♣ Accessible with the password #1

6. CONFIGURATION

ALARM AN <i>FUNCTION</i>	
<i>PARAMETERS:</i>	
SP VALUE ♣	The alarm switches from OFF to ON when the SP value is reached.
HYSTERES ♣	Establishes the alarm hysteresis. Alarms switch ON at set point but switch OFF value depends on the hysteresis setting. Hysteresis is expressed in Engineering units and is added to low alarm and subtracted from high alarm set points to establish the alarm release value.
OCCURNCE	Defines the number of alarm occurrences needed after power on for alarm operation or after start up a new batch.
CHANNEL	Channel on which alarm is applied (Analog 1..6, com 1..6, math 1..6)
AL TYPE	Type of alarm (High, low, differential, ...)
CH DIFF	Second channel used if alarm type is differential.
RELAY #	Selection of relay activated in alarm
ACTION	Action on printer in case of alarm (None, print on alarm, change range, ...)
MESSAG #	Selection of alarm message to be printed
MSG COL	Multipoint only Color of alarm message
PRNT MSG	Defines the conditions to print the message on alarm change.
AL = RED	Multipoint only Specifies if the trace of channel must be printed in red during alarm.

♣ Accessible with the password #1

6. CONFIGURATION

DIGITAL <i>FUNCTION</i>	
<i>PARAMETERS:</i>	
TYPE	Type of digital input
CH DIFF	Second digital input to use if the type is differential
ACTION	Action on printer in case of digital input change
RELAY #	Selection of relay activated
MESSAG #	Selection of message to be printed
MSG COL	Multipoint only Color of the message
PRNT MSG	Defines the condition to print the message on Event Change.
TRACE	Enables/disables the trace of the event.
TR COLOR	Multipoint only Defines color of trace.
RED TRAC	Multipoint only Specifies if digital input trace must be printed in red on event.
POSITION	Multipoint only Defines the trace position (open contact) on the chart. (In %)

MESSAGES <i>FUNCTION</i>	
<i>PARAMETERS:</i>	
MESSAGE ♣	To configure the messages. (14 characters)

♣ Accessible with the password #1

6. CONFIGURATION

CHART <i>FUNCTION</i>	
<i>PARAMETERS:</i>	
TAG NAME ♣	Tag of name corresponding chart channel
ENG UNIT	Chart channel units
DECIMAL	Decimal point configuration
MIN RG1 ♣	Lower limit of chart range 1
MAX RG1 ♣	Upper limit of chart range 1
RG1 COL ♣	Multipoint only Color of range 1
MIN RG2 ♣	Lower limit of chart range 2
MAX RG2 ♣	Upper limit of chart range 2
RG2 COL ♣	Multipoint only Color of range 2
ZONING ♣	Defines chart zone for printing. (0%-50%, 50%-100%, 0%-100%)
TRACE	Defines the variable to print (Analog input 1..6, Comm 1..6, Math 1..6, None)
RG USED	You may select whether the input channel will be printed normally (range 1 or 2) or on alarm (with range 1 or 2).

♣ Accessible with the password #1

6. CONFIGURATION

MISCEL <i>FUNCTION</i>	
<i>PARAMETERS:</i>	
TIME ♣	Real time clock setting
DATE ♣	Real time clock date
LANGUAGE	Operator information and configuration language
IDNTIF # ♣	Identification number of the instrument which will be printed on the chart.
FREQUNCY	To select the line frequency
PSSWRD 1	Used to provide a limited access to configuration
PSSWRD 2	Used to provide full access to configuration
MATH PAK	Type of optional maths package
USE CONF	Selection of the desired configuration number

♣ Accessible with the password #1

BATCH <i>FUNCTION</i>	
<i>PARAMETERS:</i>	
LINE 1	Configuration of the first line of the batch message
LINE 2	Configuration of the second line of the batch message
LINE 3	Configuration of the third line of the batch message
LINE 4	Configuration of the fourth line of the batch message
START	BATCH ACTIVATION CONDITION: The START condition defines when batch printing must start. The recorder pauses each time the start condition occurs and then prints the batch description and increments the batch number.
RESET	BATCH NUMBER RESET CONDITION: The RESET condition defines when the batch number must reset.
BATCH #	Batch number used at RESET condition.
BACKUP	Store the batch number in case of power interruption.

6. CONFIGURATION

PRINTER <i>FUNCTION</i>	
<i>PARAMETERS:</i>	
CHART LG	Total chart length of the chart roll or fanfold
SPD UNIT ♣	Speed unit (mm/h or inch/h)
SPEED1 ♣	Value of speed 1 (Using speed unit)
SPEED2 ♣	Value of speed 2
SPD USED ♣	Defines the speed in use or the tabular in use.
TABULAR 1 ♣	Multipoint only Tab 1 prints interval. (In minute)
TABULAR 2 ♣	Multipoint only Tab 2 prints interval.
REC MODE	Recording mode allows you to print normally, to stop the printer, to trigger the printer on alarm with (or without) return to stand-by.
PRT MODE	Multipoint only Under this heading you must choose whether recording will be trend mode or tabular mode.
PRT INTV	Separation (in millimeters) of PRT PV interval for periodic printing.
PRINT PV	Periodic of PV values, time and digital input status.
PRT RANG	Periodic printing of the chart ranges.
PRT TIME	Periodic printing of "TIME, DATE, SPEED, CHANNEL ID"
PRT TAG	Multipoint only Printing of the tag name with the channel number
PEN OFFS	Pen only Pen offset

♣ Accessible with the password #1

EVENT <i>FUNCTION</i>	
<i>PARAMETERS:</i>	
TYPE	Type of event
RELAY #	Selection of relay activated in event condition
DISPLAY	Enables/disables a display warning in event occurrence

6. CONFIGURATION

MMI FUNCTION	
<i>PARAMETERS:</i>	
KEY DOWN	<input type="checkbox"/> To modify the display indication in normal operation. *
KEY UP	<input type="checkbox"/> To stop the display scanning in normal operation. *
KEY LEFT	<input type="checkbox"/> To modify the printer operation. *
KEY RIGHT	<input type="checkbox"/> To reset the maths functions or batch number. *
DISPLAY ♣	Type of information to display in run mode at power on.
BRIGHT ♣	To modify the display brightness during operation.

♣ Accessible with the password #1

* See paragraph 3.2 "Basic actions" in Operation section.

CUR OUT FUNCTION *	
<i>PARAMETERS:</i>	
CH #	Defines the variable to output. (Analog input 1..6, comm 1..6, math 1.6, none)
LOW VAL	Low value for a 4 mA output
HIGH VAL	High value for a 20 mA output

* This function appears only if the current output board is present.

7. DETAILED CONFIGURATION

7.1 PARAMETERS LIST

<i>FUNCTION</i>	<i>PARAMETER</i>	<i>CLASSIFICATION</i>
NAME OF THE FUNCTION	NAME OF THE PARAMETER	IMPORTANCE OF THE PARAMETER : ◆ RARELY USED ◆◆ NOT OFTEN USED ◆◆◆ OFTEN USED
<i>DEFINITION :</i>	EXPLAIN THE ROLE OF THE PARAMETER	
<i>HOW TO MODIFY IT :</i>	2 POSSIBILITIES : - BY SELECTING A NEW VALUE I.E. USING THE ▲ ▼ KEYS - BY ENTERING A NEW VALUE	
<i>POSSIBLE VALUES :</i>	LIST OF POSSIBLE VALUES OR LIMITS	
<i>SEE ALSO :</i>		
<i>EXAMPLE :</i>		
<i>NOTE :</i>		
<i>WARNING :</i>		

7. DETAILED CONFIGURATION

- ➡ANALOG
- ➡ALARM AN
- ➡DIGITAL
- ➡MESSAGES
- ➡CHART
- ➡MISCEL
- ➡BATCH
- ➡PRINTER
- ➡EVENT
- ➡MMI
- ➡CUR OUT

7. DETAILED CONFIGURATION

FUNCTION



ANALOG

PARAMETERS



SENSOR



RANGE



T/C COMP



FILTER



LOW VAL



HIGH VAL



BURN OUT



STD MATH



CH #



ZERO ADJ

7. DETAILED CONFIGURATION

FUNCTION	PARAMETER	CLASSIFICATION
ANALOG	S E N S O R	◆◆◆
DEFINITION :	Basic sensor type used on each channel.	
HOW TO MODIFY IT :	Select a new sensor.	
POSSIBLE CHOICES :	<p>Depends on the switches position on the input board.</p> <p>NOTE : Factory configuration. All CH are delivered in position T/C, mV, V, mA</p> <div style="display: flex; justify-content: space-around; align-items: center;"> <div style="text-align: center;"> <p>SLOT 1</p> <p>Channel 3 Channel 2 Channel 1</p> <p>RTD Ranges position Thermocouple mV, V Ranges position</p> <p>BOTTOM SIDE</p> </div> <div style="text-align: center;"> <p>SLOT 2</p> <p>Channel 6 Channel 5 Channel 4</p> <p>RTD Ranges position Thermocouple mV, V Ranges position</p> <p>BOTTOM SIDE</p> </div> </div> <p>THERMOCOUPLE : Sensor is a directly connected thermocouple for which internal cold junction compensation is required.</p> <p>EXT COMP 50 : Thermocouple sensor is directly connected to a remote temperature compensation box fixed at 50 °C.</p> <p>EXT COMP 60 : Thermocouple sensor is directly connected to a remote temperature compensation box fixed at 60 °C.</p> <p>RTD : Sensor is a directly connected RTD or variable resistance. Display only when switch on input board is set.</p>	

7. DETAILED CONFIGURATION

<i>FUNCTION</i>	<i>PARAMETER</i>	<i>CLASSIFICATION</i>
ANALOG	S E N S O R	◆◆◆
	<p>TR NL 0-5V : Sensor is a temperature transmitter; signal range of 0-5V is not linear with temperature.</p> <p>TR NL 1-5V : Sensor is a temperature transmitter; signal range of 1-5V is not linear with temperature.</p> <p>TR NL 0-20mA : Sensor is a temperature transmitter; signal range of 0-20mA is not linear with temperature.</p> <p>TR NL 4-20mA : Sensor is a temperature transmitter; signal range of 4-20mA is not linear with temperature.</p> <p>LINEAR : Sensor is a transmitter; output is linear with process variable.</p> <p>SPECIAL : Special sensor connected. Must be specified by special order.</p> <p>NO ENTRY : No sensor connected or unused input.</p>	
SEE ALSO :	RANGE in this function.	
NOTE :	Changing the sensor type will automatically change RANGE, LOW VAL, HIGH VAL into predefined values.	

7. DETAILED CONFIGURATION

FUNCTION	PARAMETER	CLASSIFICATION			
ANALOG	R A N G E	◆◆◆			
DEFINITION:	<p>DISPLAY ACTUATION RANGE</p> <p>For directly connected temperature sensors and non-linear temperature transmitters, the actuation selection defines the linearization routine used to produce a linear chart scale. For linear transmitters, the selection simply defines the transmitter's electrical range/span.</p> <p>The choice of actuation offered by the recorder during configuration will depend upon the sensor selected.</p>				
HOW TO MODIFY IT :	Select a new text.				
POSSIBLE CHOICES :	Depends on the type of sensor connected.				
LINEAR	RTD / OHMS Pt 100 W at 0 °C	THERMOCOUPLE			
LIN 0/10 mV LIN -10/10 mV LIN 0/20 mV LIN -20/20 mV LIN 0/50 mV LIN -50/50 mV LIN 10/50 mV LIN 0/100 mV L -100/100 mV LIN 0/500 mV L -500/500 mV LIN 0/1 V LIN -1/1 V LIN 0/2 V LIN -2/2 V LIN 0/5 V LIN -5/5 V LIN 1/5 V LIN 0/10 V LIN -10/10 V LIN 0/20 mA* LIN 4/20 mA*	RTD IEC -50/150 C** IEC -58/302 F** IEC 0/100 C** IEC 32/212 F** IEC 0/200 C** IEC 32/392 F** IEC 0/400 C** IEC 32/752 F** IEC -200/500 C** IEC -328/932 F** Ni 50 -80/320 C** Ni 50 -112/608 F** Ni 508 -50/250 C** Ni 508 -58/482 F** Cu 10 -20/250 C** Cu 10 -4/482 F** OHM 0/200 OHM 0/2000	JIS -50/150 C** JIS -58/302 F** JIS 0/100 C** JIS 32/212 F** JIS 0/200 C** JIS 32/392 F** JIS 0/400 C** JIS 32/752 F** JIS -200/500 C** JIS -328/932 F** Ni 50 -80/320 C** Ni 50 -112/608 F** Ni 508 -50/250 C** Ni 508 -58/482 F** Cu 10 -20/250 C** Cu 10 -4/482 F** OHM 0/200 OHM 0/2000	J -50/150 C J -58/302 F J 0/400 C J 32/752 F J -200/870 C J-328/1598 F L -50/150 C L -58/302 F L 0/400 C L 32/752 F L -200/870 C L-328/1598 F K 0/400 C K 32/752 F K 0/800 C K 32/1472 F K 0/1200 C K 32/2192 F K -200/1370 C K -328/2498 F R -20/1760 C R -4/3200 F	S 0/1600C S 32/2912 F S -20/1760 C S -4/3200 F N 0/400 C N 32/752 F N 0/800 C N 32/1452 F N 0/1200 C N 32/2192 F N -20/1300 C N -4/2372 F T -50/150 C T -58/302 F T 0/150 C T 32/302 F T 50/150 C T 122/302 F T -200/400 C T -328/752 F	U -50/150 C U -58/302 F U 0/150 C U 32/302 F U 50/150 C U 122/302 F U -200/400 C U -328/752 F NiMo 0/1400 C NiMo 32/2552 F W-W26 -20/2320 C W-W26 -4/4208 F W5-W26 -20/2320 C W5-W26 -4/4208 F PR20-40 0/1800 C PR20-40 32/3272 F B 40/1820 C B 104/3308 F
* mA inputs for 250 ohms input resistor. ** Accuracy = 1°C or 1.8°F					

7. DETAILED CONFIGURATION

<i>FUNCTION</i>	<i>PARAMETER</i>	<i>CLASSIFICATION</i>
ANALOG	R A N G E	◆◆◆
NOTE :	For non-linear temperature transmitter 1 to 5 VDC or 4 to 20 mA or 0 to 5 VDC or 0 to 20 mA. The transmitter range must be identical to the actuation/displays shown above. Provision for T/C input, for remote compensation box : - at fixed temperature 50 °C or 60°C. - or at not fixed temperature, one input used as remote compensation temperature measurement.	
NOTICE :	°F is used for °Fahrenheit; °C is used for °Celcius.	

7. DETAILED CONFIGURATION

<i>FUNCTION</i>	<i>PARAMETER</i>	<i>CLASSIFICATION</i>
ANALOG	T / C COMP	◆
DEFINITION :	To select a channel number used to measure the temperature of a remote compensation box. This setting eliminates the variable cold junction and implements the hot box temperature. Application : To use an uncontrolled remote compensation box channel #.	
HOW TO MODIFY IT :	Select a new value	
POSSIBLE CHOICES:	ANALOG 1 ANALOG 2 ANALOG 3 ANALOG 4 ANALOG 5 ANALOG 6 NONE	
EXAMPLE :	<p style="text-align: center;"> RECORDER REMOTE COMPENSATION BOX </p>	
NOTICE :	This temperature measurement takes the place of one analog input. For example : a 6 channels recorder becomes 5 channels input max.	

7. DETAILED CONFIGURATION

<i>FUNCTION</i>	<i>PARAMETER</i>	<i>CLASSIFICATION</i>
ANALOG	FILTER	◆
DEFINITION :	You may wish to apply a filter to noisy signals. However if you want to display and record pulses, square waves or other rapidly changing inputs without damping, choose 0 filter value.	
HOW TO MODIFY IT :	Enter a numeric value.	
POSSIBLE VALUES:	0 to 99 seconds 0 = No filter 10 = 10 seconds	
EXAMPLE :		
WARNING :	. All the alarms configured on a filtered analog input are affected by the filter delay. Be careful with the filter action for the channels on which a "rate of change" alarm is configured : the filter can suppress the alarm action.	

7. DETAILED CONFIGURATION

<i>FUNCTION</i>	<i>PARAMETER</i>	<i>CLASSIFICATION</i>
ANALOG	LOW VAL	◆◆
DEFINITION :	Engineering value corresponding to low limit of the selected input actuation range.	
HOW TO MODIFY IT :	Enter a numeric value.	
POSSIBLE VALUES :	Up to 6 digits including negative sign and decimal point. [-9999 ... 9999]	
NOTICE :	<p>Modification is not available for any directly connected temperature sensors, as this would adversely affect the linearization.</p> <p>For linear and non-linear transmitters choose the value in engineering units, which corresponds to the low range limit of the transmitter.</p>	

<i>FUNCTION</i>	<i>PARAMETER</i>	<i>CLASSIFICATION</i>
ANALOG	HIGH VAL	◆◆
DEFINITION :	Engineering value corresponding to high limit of the selected input actuation range.	
HOW TO MODIFY IT :	Enter a numeric value.	
POSSIBLE VALUES :	Up to 6 digits including negative sign and decimal point. [-9999 ... 9999]	
NOTICE :	<p>Modification is not available for any directly connected temperature sensors, as this would adversely affect the linearization.</p> <p>For linear and non-linear transmitters choose the value in engineering units, which corresponds to the high range limit of the transmitter.</p>	

7. DETAILED CONFIGURATION

<i>FUNCTION</i>	<i>PARAMETER</i>	<i>CLASSIFICATION</i>
ANALOG	BURN OUT	◆
DEFINITION :	Allows you to define the safety backup position to activate alarms (if configured) in case of sensor burnout. The trace can go either on the right (upscale) or on the left (downscale).	
HOW TO MODIFY IT :	Select new text.	
POSSIBLE CHOICES :	<p>NO B.OUT : No burn out.</p> <p>B.OUT LOW : Burn out configured downscale.</p> <p>B.OUT HIGH : Burn out configured upscale.</p> <p>FIX LOW : Burn out fixed low.</p> <p>FIX HIGH : Burn out fixed high. (RTD/OHMS) Not configurable</p> <p>FIX NONE : Burn out fixed none. (Linear sensors) -10 10 V / 0 10 V / -5 5 V / -2 2 V / -1 1 V / -500 500 mV</p>	
NOTE :	For some sensors, burn out is not configurable but fixed and display will show FIX LOW, FIX HIGH (RTD/OHMS) or FIX NONE.	
NOTICE :	For configurable burnout, be aware that a current of 0.125 mA will occur regularly and may disturb other devices connected to the same sensor.	

7. DETAILED CONFIGURATION

<i>FUNCTION</i>	<i>PARAMETER</i>	<i>CLASSIFICATION</i>
ANALOG	STD MATH	◆
DEFINITION :	2 mathematical functions are included as standard in the recorder. These functions apply only to analog inputs.	
HOW TO MODIFY IT :	Select new math function.	
POSSIBLE CHOICES :	NO OPT MATH : No math function configured. SQUARE ROOT : Square root applies to analog input. CHANNEL DIFF : Difference between the current analog input and the one configured in "CH#".	
SEE ALSO :	- CH# in this sub-matrix for CHANNEL DIFF.	
NOTE:	<p>The function result is displayed and printed on the concerned analog channel.</p> <p>- For the square root (SQUARE), the formula is :</p> $PV = \sqrt{\frac{(S - Smin) (HIGH VAL2 - LOW VAL2)}{(Smax - Smin)}} + LOW VAL2$ <p>Smin = min. sensor input value Smax = max. sensor input value S = current sensor input value HIGH = high scale value LOW = low scale value</p> <p>- For CHANNEL DIFF, the formula is : PV = PV_A - PV_B A and B are any analog input.</p>	

7. DETAILED CONFIGURATION

<i>FUNCTION</i>	<i>PARAMETER</i>	<i>CLASSIFICATION</i>
ANALOG	CH #	◆
<i>DEFINITION :</i>	Second channel used when OPT MATH = CH DIFF	
<i>HOW TO MODIFY IT :</i>	Select a new value.	
<i>POSSIBLE CHOICES :</i>	ANALOG 1 ANALOG 3 ANALOG 4 ANALOG 5 ANALOG 6 NONE	
<i>NOTE:</i>	Analog input must be already configured to be accepted by the software.	

7. DETAILED CONFIGURATION

<i>FUNCTION</i>	<i>PARAMETER</i>	<i>CLASSIFICATION</i>
ANALOG	ZERO ADJ	◆
DEFINITION :	Zero adjustment means to offset/bias the calibration of the input. Otherwise choose 0 Value = Factory Calibration Adjustments are made directly in Engineering unit. (ex.:5 = 5°C)	
HOW TO MODIFY IT :	Enter a numeric value.	
POSSIBLE CHOICES :	Up to 3 digits including negative sign and decimal point. [-99 ... 99]	
EXAMPLE :		

7. DETAILED CONFIGURATION

FUNCTION



ALARM AN

PARAMETERS



SP VALUE



HYSTERES



OCCURNCE



CHANNEL



AL TYPE



CH DIFF



RELAY #



ACTION



MESSAG #



MSG COL



PRNT MSG



AL = RED

7. DETAILED CONFIGURATION

<i>FUNCTION</i>	<i>PARAMETER</i>	<i>CLASSIFICATION</i>
ALARM AN	SP VALUE	◆◆◆
DEFINITION :	The alarm switches from OFF to ON when the SP value is reached.	
HOW TO MODIFY IT :	Enter a numeric value.	
POSSIBLE CHOICES :	Up to 8 digits in Engineering unit of the display range. [-9999999 ... 9999999]	
SEE ALSO :	Alarm type in the same function	
EXAMPLE :	<p>High alarm type :</p>	

7. DETAILED CONFIGURATION

<i>FUNCTION</i>	<i>PARAMETER</i>	<i>CLASSIFICATION</i>
ALARM AN	HYSERESIS	◆◆
DEFINITION :	<p>Establishes the alarm hysteresis. Alarms switch ON at set point but switch OFF value depends on the hysteresis setting.</p> <p>Hysteresis is expressed in Engineering units and is added to low alarm and subtracted from high alarm set points to establish the alarm release value.</p>	
HOW TO MODIFY IT :	Enter a numeric value. (Up to 3 digits)	
POSSIBLE VALUES :	[0 ... 999]	
EXAMPLE :		
NOTE :	With CHG rate type, this parameter is expressed in Engineering units.	

7. DETAILED CONFIGURATION

<i>FUNCTION</i>	<i>PARAMETER</i>	<i>CLASSIFICATION</i>
ALARM AN	OCCURANCES	◆
DEFINITION :	Defines the number of alarm occurrences that must be discarded after power on before alarm activation can actually occur.	
HOW TO MODIFY IT :	Select a new value.	
POSSIBLE VALUES :	: [0 ... 9] 0 = No alarm occurrence (ie : normal alarm activation) 1 = 1 alarm occurrence 2 = 2 alarm occurrences . . . 9 = 9 alarm occurrences	
EXAMPLE :	<div style="text-align: center;"> </div> <p>High alarm type configured with alarm occurrence = 1 At start up (power on) PV < SP, the alarm is inactive. The first alarm (occurrence #1) is discarded, the second alarm is actually activated.</p>	

7. DETAILED CONFIGURATION

<i>FUNCTION</i>	<i>PARAMETER</i>	<i>CLASSIFICATION</i>
ALARM AN	CHANNEL	◆◆◆
DEFINITION :	Channel on which alarm is applied. (Analog 1..6, com 1..6, math 1..6)	
HOW TO MODIFY IT :	Select a new value.	
POSSIBLE CHOICES :	ANALOG 1 ANALOG 2 ANALOG 3 ANALOG 4 ANALOG 5 ANALOG 6 COMM 1 COMM 2 COMM 3 COMM 4 COMM 5 COMM 6 MATH 1 MATH 2 MATH 3 MATH 4 MATH 5 MATH 6	

7. DETAILED CONFIGURATION

<i>FUNCTION</i>	<i>PARAMETER</i>	<i>CLASSIFICATION</i>
ALARM AN	AL TYPE	◆◆◆
DEFINITION :	Type of alarm (High, low, differential ...)	
HOW TO MODIFY IT :	Select a new alarm type.	
POSSIBLE CHOICES :	<p>NONE : Select "none" for unused alarms.</p> <p>ALARM HIGH : alarm to occur when the value equals or exceeds the alarm setpoint.</p> <p>ALARM LOW : alarm to occur when the value equals or is below the alarm setpoint.</p> <p>CHG RATE H : alarm to occur if the trace increases quicker than the alarm setting (setpoint is given in eng.unit/second).</p> <p>CHG RATE L : alarm to occur if the trace decreases quicker than the alarm setting (setpoint is given in eng.unit/second).</p> <p>CHG RATE H, L : alarm to occur if the trace increases/decreases quicker than the alarm setting (setpoint is given in eng.unit/second).</p> <p>DIFFERENTIAL : occurs if the absolute difference between the values of the specified channel and a second channel exceeds the alarm setpoint.</p>	
SEE ALSO :	CH DIFF for DIFFERENTIAL in this function.	
EXAMPLE :		

7. DETAILED CONFIGURATION

<i>FUNCTION</i>	<i>PARAMETER</i>	<i>CLASSIFICATION</i>
ALARM AN	AL TYPE	◆◆◆
<p>The diagrams illustrate four types of alarm configurations:</p> <ul style="list-style-type: none"> CHG RATE H: A graph showing a process value (PV) increasing linearly over time (t). A shaded triangular area above the PV line between points PV₁ and PV₂ is labeled "CHG RATE H". The slope is defined as $SP = \frac{PV_2 - PV_1}{\Delta T}$. CHG RATE L: A graph showing a process value (PV) decreasing linearly over time (t). A shaded triangular area below the PV line between points PV₁ and PV₂ is labeled "CHG RATE L". CHG RATE H, L: Two graphs side-by-side. The left graph shows a rising PV line with a shaded area above it labeled "ON". The right graph shows a falling PV line with a shaded area below it labeled "ON". DIFFERENTIAL: A graph showing two wavy lines representing process values over time. The upper line is labeled "Reference CH" and the lower line is labeled "Variable CH". A vertical line indicates a differential between the two. 		

7. DETAILED CONFIGURATION

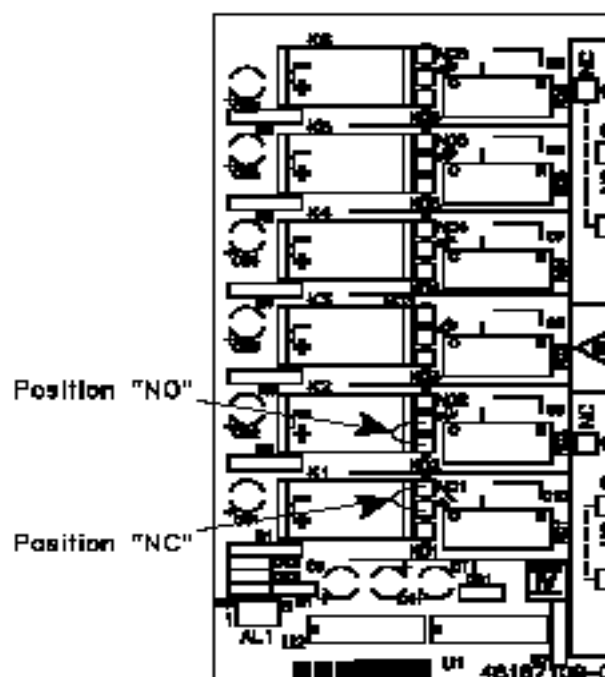
<i>FUNCTION</i>	<i>PARAMETER</i>	<i>CLASSIFICATION</i>
ALARM AN	AL TYPE	◆◆◆
<div style="display: flex; align-items: flex-start;"> <div style="margin-right: 20px;">  <p>CAUTION</p> <p>OBSERVE ANTI STATIC PRECAUTIONS</p> <p>Full anti-static precautions MUST be observed when in contact with electronics of your recorder</p> <p>Failure to comply with these instructions could cause death or seious injury</p> </div> <div> <p>RELAY OUTPUT CONFIGURATION</p> <p>All the relays are factory configured to be de-energized under alarm conditions.</p> <p>Each relay is factory set for NC (normally closed) operation by a jumper on the alarm board.</p> <p>If you need to reverse this operation. (See figure below)</p> <ul style="list-style-type: none"> - Remove the upper chassis plate and rear terminal. - Remove the alarm relay board. - Move the jumper from the NC location (normally closed) to the NO location (normally open). <div style="text-align: center; margin: 20px 0;">  </div> <ul style="list-style-type: none"> - Reinstall the alarm board. - Reinstall the upper chassis plate. - Reinstall the rear terminal block. </div> </div>		

7. DETAILED CONFIGURATION

<i>FUNCTION</i>	<i>PARAMETER</i>	<i>CLASSIFICATION</i>
ALARM AN	CH DIFF	◆
DEFINITION :	Second channel to use if alarm type is differential.	
HOW TO MODIFY IT :	Select a new value.	
POSSIBLE CHOICES :	The same as those for alarm channel. ANALOG 1 ANALOG 2 ANALOG 3 ANALOG 4 ANALOG 5 ANALOG 6 COMM 1 COMM 2 COMM 3 COMM 4 COMM 5 COMM 6 MATH 1 MATH 2 MATH 3 MATH 4 MATH 5 MATH 6	

7. DETAILED CONFIGURATION

<i>FUNCTION</i>	<i>PARAMETER</i>	<i>CLASSIFICATION</i>
ALARM AN	RELAY	◆◆◆
<i>DEFINITION :</i>	Selection of relay to activate in alarm.	
<i>HOW TO MODIFY IT :</i>	Select a new relay number.	
<i>POSSIBLE CHOICES :</i>	NO RELAY RELAY 1 RELAY 2 RELAY 3 RELAY 4 RELAY 5 RELAY 6 RELAY 7 RELAY 8 RELAY 9 RELAY 10 RELAY 11 RELAY 12	

7. DETAILED CONFIGURATION

<i>FUNCTION</i>	<i>PARAMETER</i>	<i>CLASSIFICATION</i>
ALARM AN	ACTION	◆◆◆
DEFINITION :	Action on printer or on math functions in case of alarm (None, print on al.,change range...)	
HOW TO MODIFY IT :	Select a new alarm action.	
POSSIBLE CHOICES :	<p>NO ACTION : No effect on printing</p> <p>CHG SPD/TAB2 : Change to chart speed/print interval 2 if SPD USED = SPD/TAB1 and to speed/print interval 1 if SPD USED = SPD/TAB2.</p> <p>CHG RANGE 2 : Change to range 2 if RG USED = with R1 and to range 1 if RG USED = with R2</p> <p>*PRINT ON AL : Print the channel in alarm condition.</p> <p>PRN INHIBIT : Stop all printing</p> <p>PV TAB TRACE : Print one tabular snapshot of values superposed on traces.</p> <p>*PV TAB BLANK : Print one tabular snapshot of values on blank paper.</p> <p>*TRIG EV PREC : Triggers "event precursor" printing</p> <p>**PRT MATH LOG : Print one tabular snapshot of math results</p> <p>**HOLD MATH1 : Hold Math1 calculation</p> <p>**HOLD MATH2 : Hold Math2 calculation</p> <p>**HOLD MATH3 : Hold Math3 calculation</p> <p>**HOLD MATH4 : Hold Math4 calculation</p> <p>**HOLD MATH5 : Hold Math5 calculation</p> <p>**HOLD MATH6 : Hold Math6 calculation</p>	
SEE ALSO :	<p>RG USED in CHART FUNCTION for PRINT ON AL</p> <p>REC MODE in PRINTER FUNCTION for TRIG EV PREC</p>	
NOTE:	<p>* Available only on Multipoint recorders.</p> <p>** Available only if the Math functions are released.</p>	
NOTICE :	When the alarm state switches from ON to OFF or conversely and when recorder is configured with PRN INHIBIT : the messages, the PV printout and the batch messages are not printed.	

7. DETAILED CONFIGURATION

<i>FUNCTION</i>	<i>PARAMETER</i>	<i>CLASSIFICATION</i>
ALARM AN	MESSAG#	◆◆◆
DEFINITION :	Selection of alarm message to be printed.	
HOW TO MODIFY IT :	Select a new message number.	
POSSIBLE CHOICES :	MESSAGE #2 MESSAGE #3 MESSAGE #4 MESSAGE #5 MESSAGE #6 MESSAGE #7 MESSAGE #8 MESSAGE #9 MESSAGE #10 MESSAGE #11 MESSAGE #12	
SEE ALSO :	PRNT MSG in this function	
NOTICE :	Be sure the selected message is already configured. (See Matrix Message)	

7. DETAILED CONFIGURATION

<i>FUNCTION</i>	<i>PARAMETER</i>	<i>CLASSIFICATION</i>
ALARM AN	MSG COL	◆◆
<i>DEFINITION :</i>	Color of alarm message	
<i>HOW TO MODIFY IT :</i>	Select a new color.	
<i>POSSIBLE CHOICES :</i>	PURPLE RED BLACK GREEN BLUE BROWN	
<i>NOTICE :</i>	THIS FUNCTION IS ONLY AVAILABLE FOR MULTIPOINT RECORDERS.	

7. DETAILED CONFIGURATION

<i>FUNCTION</i>	<i>PARAMETER</i>	<i>CLASSIFICATION</i>
ALARM AN	PRNT MSG	◆
DEFINITION :	Defines the conditions to print the message on alarm change.	
HOW TO MODIFY IT :	Select a new message type.	
POSSIBLE CHOICES :	<p>NONE : No standard (message with date time), no operator message, and no action message (change speed, printer ON/OFF) are printed.</p> <p>NO MESSAGE : No operator message is printed but date, time and standard alarm message are printed.</p> <p>MESSAGE ON : Operator message is printed at alarm occurrence only.</p> <p>MESSAGE OFF : Operator message is printed at alarm release only.</p> <p>MSG ON, OFF : Operator message is printed at alarm activation and at alarm release.</p>	
SEE ALSO :	MESSAGE in MESSAGES FUNCTION	

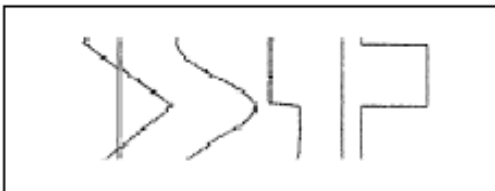

NONE

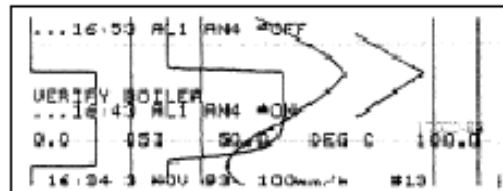

MESSAGE ON

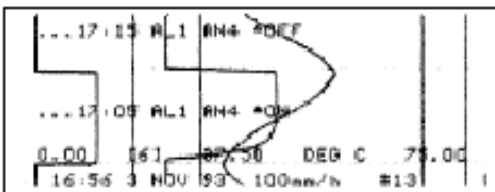

NO MESSAGE

7. DETAILED CONFIGURATION

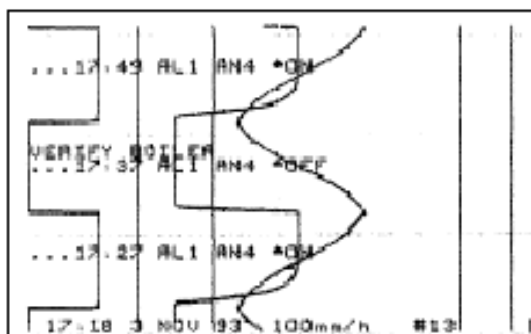

MESSAGE OFF

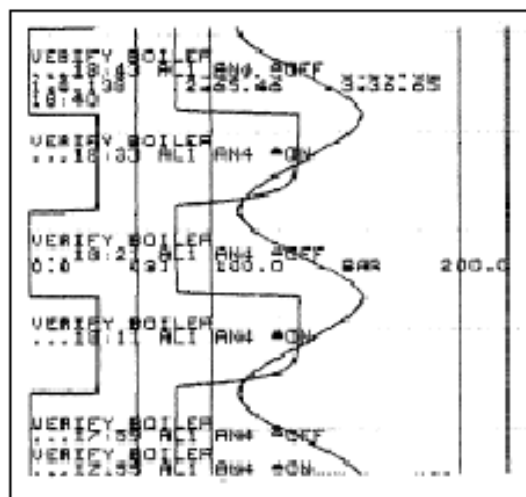

MSG ON, OFF

<i>FUNCTION</i>	<i>PARAMETER</i>	<i>CLASSIFICATION</i>
ALARM AN	AL = RED	◆
DEFINITION :	Specify if the trace of channel must be printed in red during alarm.	
HOW TO MODIFY IT :	Choose a new selection.	
POSSIBLE CHOICES :	NO YES	
NOTICE :	If AL = Red is selected, do not configure the trace color in red as normal printing. THIS FUNCTION IS ONLY AVAILABLE FOR MULTIPOINT RECORDERS.	

7. DETAILED CONFIGURATION

FUNCTION



DIGITAL INPUTS

PARAMETERS



TYPE



CH DIFF



ACTION



RELAY #



MESSAG #



MSG COL



PRNT MSG



TRACE



TR COLOR



RED TRAC



POSITION

7. DETAILED CONFIGURATION

<i>FUNCTION</i>	<i>PARAMETER</i>	<i>CLASSIFICATION</i>
DIGITAL	TYPE	◆◆
DEFINITION :	Type of digital input.	
HOW TO MODIFY IT :	Select a new digital input type.	
POSSIBLE CHOICES :	<p>NONE : Select "none" for unused digital input.</p> <p>DIG CLOSED : when logic input is ON (contact closed).</p> <p>DIG OPEN : when logic input is OFF (contact opened).</p> <p>CHG RATE H : when logic input is changing from OFF to ON.</p> <p>CHG RATE L : when logic input is changing from ON to OFF.</p> <p>CHG RATE H, L : when logic input is changing in either direction.</p> <p>DIFFERENTIAL : when logic input changes to a different state from another specified logic input. (Function OR)</p>	
SEE ALSO :	CH DIFF for DIFFERENTIAL in this sub-matrix.	
EXAMPLE :	 <p>The diagram shows a digital signal waveform. It starts at a low level, then transitions to a high level. This transition is labeled "CONTACT ON (closed)". The signal remains at the high level for a period, then transitions back to a low level. This transition is labeled "CONTACT OFF (opened)".</p>	

7. DETAILED CONFIGURATION

<i>FUNCTION</i>	<i>PARAMETER</i>	<i>CLASSIFICATION</i>
DIGITAL	TYPE	◆◆
	 <p style="text-align: center;">CHG RATE H CHG RATE L</p>	
<i>FUNCTION</i>	<i>PARAMETER</i>	<i>CLASSIFICATION</i>
DIGITAL	CH DIFF	◆
DEFINITION :	Second digital input to use if the type is differential.	
HOW TO MODIFY IT :	Select a new value.	
POSSIBLE CHOICES :	DIGITAL 1 DIGITAL 2 DIGITAL 3 DIGITAL 4	

7. DETAILED CONFIGURATION

<i>FUNCTION</i>	<i>PARAMETER</i>	<i>CLASSIFICATION</i>
DIGITAL	ACTION	◆◆
DEFINITION :	Action on printer in case of digital input change.	
HOW TO MODIFY IT :	Select a new action.	
POSSIBLE CHOICES :	<p>NO ACTION : No effect on printing</p> <p>CHG SPD/TAB2 : Change to chart speed/print interval 2 if SPD USED = SPD/TAB1 and to speed/print interval 1 if SPD USED = SPD/TAB2.</p> <p>CHG RANGE 2 : Change to range 2 if RG USED = with R1 and to range 1 if RG USED = with R2</p> <p>*PRINT ON AL : Print the channel in alarm condition.</p> <p>PRN INHIBIT : Stop all printing</p> <p>PV TAB TRACE : Print one tabular snapshot of values superposed on traces.</p> <p>*PV TAB BLANK : Print one tabular snapshot of values on blank paper.</p> <p>*TRIG EV PREC : Triggers "event precursor" printing</p> <p>**PRT MATH LOG : Print one tabular snapshot of math results</p>	
SEE ALSO :	<p>RG USED in CHART FUNCTION for PRINT ON AL</p> <p>REC MODE in PRINTER FUNCTION for TRIG EV PREC</p>	
NOTE:	<p>* Available only on Multipoint recorders.</p> <p>** Available only if the Math functions are released.</p>	
NOTICE :	When the digital event state switches from ON to OFF or conversely and when recorder is configured with PRN INHIBIT : the messages, the PV printout and the batch messages are not printed.	

7. DETAILED CONFIGURATION

<i>FUNCTION</i>	<i>PARAMETER</i>	<i>CLASSIFICATION</i>
DIGITAL	RELAY	◆◆
<i>DEFINITION :</i>	Selection of relay activated.	
<i>HOW TO MODIFY IT :</i>	Select a new relay number.	
<i>POSSIBLE CHOICES :</i>	NO RELAY RELAY 1 RELAY 2 RELAY 3 RELAY 4 RELAY 5 RELAY 6 RELAY 7 RELAY 8 RELAY 9 RELAY 10 RELAY 11 RELAY 12	

7. DETAILED CONFIGURATION

<i>FUNCTION</i>	<i>PARAMETER</i>	<i>CLASSIFICATION</i>
DIGITAL	MESSAG #	◆◆
<i>DEFINITION :</i>	Selection of message to be printed.	
<i>HOW TO MODIFY IT :</i>	Select a new message number.	
<i>POSSIBLE CHOICES :</i>	MESSAGE #1 MESSAGE #2 MESSAGE #3 MESSAGE #4 MESSAGE #5 MESSAGE #6 MESSAGE #7 MESSAGE #8 MESSAGE #9 MESSAGE #10 MESSAGE #11 MESSAGE #12	
<i>SEE ALSO :</i>	PRNT MSG in this sub-matrix	

7. DETAILED CONFIGURATION

<i>FUNCTION</i>	<i>PARAMETER</i>	<i>CLASSIFICATION</i>
DIGITAL	MSG COL	◆◆
<i>DEFINITION :</i>	Color of the message.	
<i>HOW TO MODIFY IT :</i>	Select a new color.	
<i>POSSIBLE CHOICES :</i>	PURPLE RED BLACK GREEN BLUE BROWN	
<i>NOTICE:</i>	THIS FUNCTION IS ONLY AVAILABLE FOR MULTIPOINT RECORDERS.	

7. DETAILED CONFIGURATION

<i>FUNCTION</i>	<i>PARAMETER</i>	<i>CLASSIFICATION</i>
DIGITAL	PRNT MSG	◆
DEFINITION :	Defines the condition to print the message on Change.	
HOW TO MODIFY IT :	Select a new PRNT MSG type.	
POSSIBLE CHOICES :	<p>NONE : No standard (message with date time), no operator message and no action message (change speed, printer ON/OFF) are printed.</p> <p>NO MESSAGE : No operator message is printed but date, time and standard digital message are printed.</p> <p>MESSAGE ON : Operator message is printed at digital event occurrence only.</p> <p>MESSAGE OFF : Operator message is printed at digital event release only.</p> <p>MSG ON, OFF : Operator message is printed at digital event activation and at digital event release.</p>	

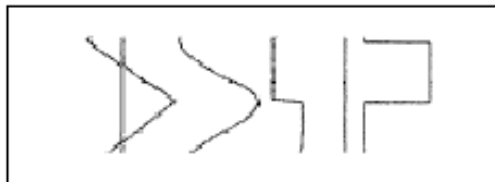

NONE

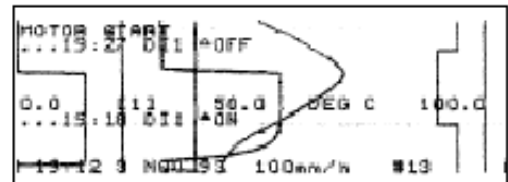

MESSAGE OFF

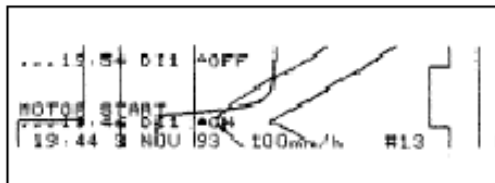

MESSAGE ON

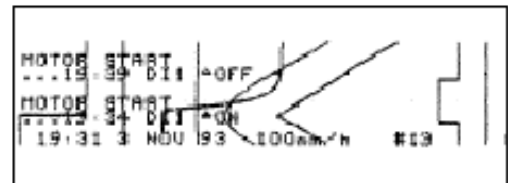

MSG ON, OFF

7. DETAILED CONFIGURATION

<i>FUNCTION</i>	<i>PARAMETER</i>	<i>CLASSIFICATION</i>
DIGITAL	TRACE	◆◆
<i>DEFINITION :</i>	Enable/disable the trace of the event.	
<i>POSSIBLE CHOICES :</i>	ENABLE DISABLE	
<i>FUNCTION</i>	<i>PARAMETER</i>	<i>CLASSIFICATION</i>
DIGITAL	TR COLOR	◆
<i>DEFINITION :</i>	Defines color of trace.	
<i>HOW TO MODIFY IT :</i>	Select a new color.	
<i>POSSIBLE CHOICES :</i>	PURPLE RED BLACK GREEN BLUE BROWN	
<i>NOTICE :</i>	THIS FUNCTION IS ONLY AVAILABLE FOR MULTIPOINT RECORDERS.	

7. DETAILED CONFIGURATION

<i>FUNCTION</i>	<i>PARAMETER</i>	<i>CLASSIFICATION</i>
DIGITAL	RED TRACE	◆
DEFINITION :	Specify if digital input trace must be printed in red on event.	
HOW TO MODIFY IT :	Select a new value.	
POSSIBLE CHOICES :	NO YES	
WARNING :	If the RED TRAC is selected: do not configure the trace in red as normal printing. THIS FUNCTION IS ONLY AVAILABLE FOR MULTIPOINT RECORDERS.	
<i>FUNCTION</i>	<i>PARAMETER</i>	<i>CLASSIFICATION</i>
DIGITAL	POSITION	◆
DEFINITION :	Defines the trace position (open contact) on the chart. (in %) THE AMPLITUDE OF THE EVENT TRACE CANNOT BE ADJUSTED.	
NOTICE:	THIS FUNCTION IS ONLY AVAILABLE FOR MULTIPOINT RECORDERS.	

7. DETAILED CONFIGURATION

FUNCTION



MESSAGES

PARAMETERS



MESSAGE

<i>FUNCTION</i>	<i>PARAMETER</i>	<i>CLASSIFICATION</i>
MESSAGES	MESSAGE	◆◆◆
<i>DEFINITION :</i>	To configure the 1 up to 12 messages (14 characters)	
<i>HOW TO MODIFY IT :</i>	Enter a text digit by digit with the ▲ ▼ keys	
<i>POSSIBLE CHOICES :</i>	14 characters	
<i>NOTICE:</i>	If the message is larger than 14 characters, the last digit takes the place of the first one, giving a wrong message.	

7. DETAILED CONFIGURATION

FUNCTION	➔	CHART
PARAMETERS	➔	TAG NAME
PARAMETERS	➔	ENG UNIT
PARAMETERS	➔	DECIMAL
PARAMETERS	➔	MIN RG1
PARAMETERS	➔	MAX RG1
PARAMETERS	➔	RG1 COL
PARAMETERS	➔	MIN RG2
PARAMETERS	➔	MAX RG2
PARAMETERS	➔	RG2 COL
PARAMETERS	➔	ZONING
PARAMETERS	➔	TRACE
PARAMETERS	➔	RG USED

7. DETAILED CONFIGURATION

<i>FUNCTION</i>	<i>PARAMETER</i>	<i>CLASSIFICATION</i>
CHART	TAG NAME	◆◆◆
DEFINITION :	Tag of name corresponding chart channel.	
HOW TO MODIFY IT :	Enter a text.	
POSSIBLE CHOICES :	8 characters	
NOTICE :	If the message is larger than 8 characters, the last digit takes the place of the first one, giving a wrong tag.	
<i>FUNCTION</i>	<i>PARAMETER</i>	<i>CLASSIFICATION</i>
CHART	ENG UNIT	◆◆◆
DEFINITION :	Chart channel units.	
HOW TO MODIFY IT :	Enter a text	
POSSIBLE CHOICES :	5 characters max.	
EXAMPLES :	mm/h - ms/mn - Deg F - Deg C - PSI - BAR	

7. DETAILED CONFIGURATION

<i>FUNCTION</i>	<i>PARAMETER</i>	<i>CLASSIFICATION</i>
CHART	DECIMAL	◆◆◆
<i>DEFINITION :</i>	Decimal point configuration for display in trace mode and chart printing. The configuration of the decimal point is used for: <ul style="list-style-type: none">- Tabular printing- PV printing- Range messages printing- Trace displaying	
<i>HOW TO MODIFY IT :</i>	Select a new choice.	
<i>POSSIBLE CHOICES :</i>	AUTO XXXXX XXX.X XX.XX X.XXX	

7. DETAILED CONFIGURATION

<i>FUNCTION</i>	<i>PARAMETER</i>	<i>CLASSIFICATION</i>
CHART	MIN RG1	◆◆
<i>DEFINITION :</i>	Lower limit of chart range 1.	
<i>HOW TO MODIFY IT :</i>	Enter a numeric value.	
<i>POSSIBLE VALUES :</i>	Up to 5 digits for analog inputs, communication inputs. Up to 8 digits for mathematic results. Including negative sign and decimal points.	
<i>EXAMPLE :</i>	<p>The diagram illustrates a horizontal axis representing a chart range. On the left side, there is a vertical tick mark labeled '0'. On the right side, there is another vertical tick mark labeled '100 %'. A horizontal line connects these two tick marks. Below this line, the text 'Chart range 1' is centered. Above the '0' tick mark, the text 'Low limit value' is written. A vertical line extends downwards from '0', and another vertical line extends downwards from '100 %'. A horizontal line connects these two downward-extending lines, forming a bracket that spans the width of the chart range.</p>	
<i>NOTICE :</i>	Do not use more than 5 digits for analog inputs and communication inputs.	

7. DETAILED CONFIGURATION

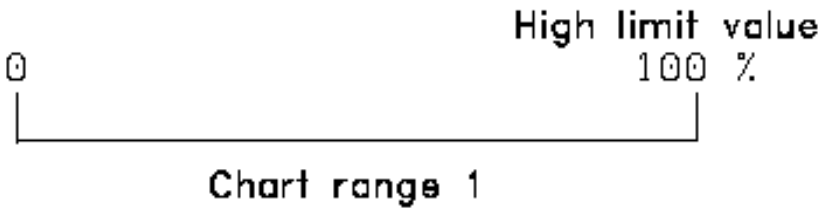
<i>FUNCTION</i>	<i>PARAMETER</i>	<i>CLASSIFICATION</i>
CHART	MAX RG1	◆
DEFINITION :	Upper limit of chart range 1.	
HOW TO MODIFY IT :	Enter a numeric value.	
POSSIBLE VALUES :	Up to 5 digits for analog inputs, communication inputs. Up to 8 digits for mathematic results. Including negative sign and decimal points.	
EXAMPLE :	 <p style="text-align: center;">High limit value 100 % Chart range 1</p>	
NOTICE :	Do not use more than 5 digits for analog inputs and communication inputs.	

7. DETAILED CONFIGURATION

<i>FUNCTION</i>	<i>PARAMETER</i>	<i>CLASSIFICATION</i>
CHART	RG1 COL	◆
<i>DEFINITION :</i>	Color of range 1	
<i>HOW TO MODIFY IT :</i>	Select a new color.	
<i>POSSIBLE VALUES :</i>	PURPLE RED BLACK GREEN BLUE BROWN	
<i>NOTICE :</i>	THIS FUNCTION IS ONLY AVAILABLE FOR MULTIPOINT RECORDERS.	

7. DETAILED CONFIGURATION

<i>FUNCTION</i>	<i>PARAMETER</i>	<i>CLASSIFICATION</i>
CHART	MIN RG2	◆◆
DEFINITION :	Lower limit of chart range 2.	
HOW TO MODIFY IT :	Enter a numeric value.	
POSSIBLE VALUES :	Up to 5 digits for analog inputs, communication inputs. Up to 8 digits for mathematic results. Including negative sign and decimal points.	
EXAMPLE :	<p style="text-align: center;">Chart range 2</p>	
NOTICE :	Do not use more than 5 digits for analog inputs and communication inputs.	

7. DETAILED CONFIGURATION

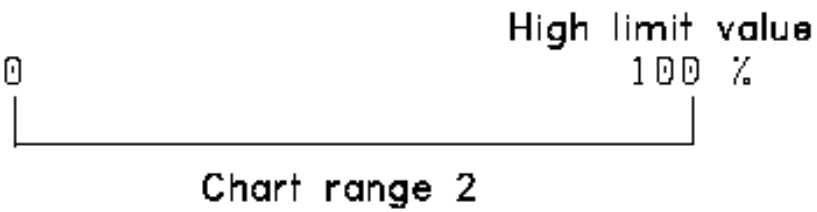
<i>FUNCTION</i>	<i>PARAMETER</i>	<i>CLASSIFICATION</i>
CHART	MAX RG2	◆
DEFINITION :	Upper limit of chart range 2.	
HOW TO MODIFY IT :	Enter a numeric value.	
POSSIBLE VALUES :	Up to 5 digits for analog inputs, communication inputs. Up to 8 digits for mathematic results. Including negative sign and decimal points.	
EXAMPLE :		
NOTICE :	Do not use more than 5 digits for analog inputs and communication inputs.	

7. DETAILED CONFIGURATION

<i>FUNCTION</i>	<i>PARAMETER</i>	<i>CLASSIFICATION</i>
CHART	RG2 COL	◆
<i>DEFINITION :</i>	Color of range 2	
<i>HOW TO MODIFY IT :</i>	Select a new color.	
<i>POSSIBLE VALUES :</i>	PURPLE RED BLACK GREEN BLUE BROWN	
<i>NOTICE :</i>	THIS FUNCTION IS ONLY AVAILABLE FOR MULTIPOINT RECORDERS.	

7. DETAILED CONFIGURATION

<i>FUNCTION</i>	<i>PARAMETER</i>	<i>CLASSIFICATION</i>
CHART	ZONING	◆
DEFINITION :	Defines chart zone for printing.	
HOW TO MODIFY IT :	Select a new value.	
POSSIBLE CHOICES :	<p>[0..100%] PAPER : min. ranges will correspond to the 0% position of paper, max. ranges will correspond to the 100% position.</p> <p>[0..50%] PAPER : min. ranges will correspond to the 0% position of paper, max. ranges will correspond to the 50% position.</p> <p>[50..100%] PAPER : min. ranges will correspond to the 50% position of paper, max. ranges will correspond to the 100% position.</p>	
<p>The diagrams show three different chart zoning configurations on a grid. The first diagram, labeled '0...50% PAPER', shows a curve that starts at the left edge and ends at the 50% mark. The second diagram, labeled '0...100% PAPER', shows a curve that starts at the left edge and ends at the 100% mark. The third diagram, labeled '50...100% PAPER', shows a curve that starts at the 50% mark and ends at the 100% mark. Each diagram includes labels for 'TAG_NAME' and 'UNIT 50'. A scale at the bottom indicates 0 and 100.</p>		

7. DETAILED CONFIGURATION

<i>FUNCTION</i>	<i>PARAMETER</i>	<i>CLASSIFICATION</i>
CHART	TRACE	◆
<i>DEFINITION :</i>	Defines the variable to print (Analog input 1...6. Comm 1...6, Math 1...6. None)	
<i>HOW TO MODIFY IT :</i>	Select a new value.	
<i>POSSIBLE CHOICES :</i>	NO TRACE ANALOG 1 ANALOG 2 ANALOG 3 ANALOG 4 ANALOG 5 ANALOG 6 COMM 1 COMM 2 COMM 3 COMM 4 COMM 5 COMM 6 MATH 1 MATH 2 MATH 3 MATH 4 MATH 5 MATH 6	

7. DETAILED CONFIGURATION

<i>FUNCTION</i>	<i>PARAMETER</i>	<i>CLASSIFICATION</i>
CHART	RG USED	◆
<i>DEFINITION :</i>	You may select whether the input channel will be printed normally (range 1 or 2) or on alarm (with range 1 or 2)	
<i>HOW TO MODIFY IT :</i>	Select a new value.	
<i>POSSIBLE VALUES :</i>	WITH R1 (WITH RANGE1) WITH R2 (WITH RANGE2) R1 ON ALARM (WITH RANGE1 ON ALARM) R2 ON ALARM (WITH RANGE2 ON ALARM)	
<i>SEE ALSO :</i>	Action in ALARM AN for R1 and R2 on Alarm.	

7. DETAILED CONFIGURATION

FUNCTION	➔	MISCEL
PARAMETERS	➔	TIME
PARAMETERS	➔	DATE
PARAMETERS	➔	LANGUAGE
PARAMETERS	➔	IDNTIF
PARAMETERS	➔	FREQUENCY
PARAMETERS	➔	PSSWRD
PARAMETERS	➔	PSSWRD
PARAMETERS	➔	MATH PAK
PARAMETERS	➔	USE CONF

7. DETAILED CONFIGURATION

<i>FUNCTION</i>	<i>PARAMETER</i>	<i>CLASSIFICATION</i>
MISCEL	TIME	◆
DEFINITION :	Real time clock setting	
HOW TO MODIFY IT :	Enter a new value for hour. Then press ENTER Enter a new value for minutes. Then press ENTER	
POSSIBLE CHOICES :	00:00 up to 23:59	
<i>FUNCTION</i>	<i>PARAMETER</i>	<i>CLASSIFICATION</i>
MISCEL	DATE	◆
DEFINITION :	Real time clock date.	
HOW TO MODIFY IT :	Enter a new value for day. Then press ENTER Select a new value for month. Then press ENTER Enter a new value for year. Then press ENTER	

7. DETAILED CONFIGURATION

<i>FUNCTION</i>	<i>PARAMETER</i>	<i>CLASSIFICATION</i>
MISCEL	LANGUAGE	◆◆◆
DEFINITION :	Operator information and configuration language.	
HOW TO MODIFY IT :	Select a new language	
POSSIBLE CHOICES :	ENGLISH FRENCH GERMAN SPANISH ITALIAN SWEDISH	
<i>FUNCTION</i>	<i>PARAMETER</i>	<i>CLASSIFICATION</i>
MISCEL	IDNTIF #	◆◆
DEFINITION :	Identification number of the instrument which will be printed on the chart.	
HOW TO MODIFY IT :	Enter a numeric value.	
POSSIBLE VALUES :	[0 ... 99]	

7. DETAILED CONFIGURATION

<i>FUNCTION</i>	<i>PARAMETER</i>	<i>CLASSIFICATION</i>
MISCEL	FREQUENCY	◆
<i>DEFINITION :</i>	To select the line frequency.	
<i>HOW TO MODIFY IT :</i>	Select a new frequency. .	
<i>POSSIBLE VALUES :</i>	50 Hz 60 Hz	
<i>NOTE:</i>	This value is important to improve serial mode rejection at power supply frequency. In case of DC power supply, use the line frequency of the country.	

7. DETAILED CONFIGURATION

<i>FUNCTION</i>	<i>PARAMETER</i>	<i>CLASSIFICATION</i>
MISCEL	PSSWRD 1	◆
DEFINITION :	Used to provide a limited access to configuration.	
HOW TO MODIFY IT :	Enter a text.	
POSSIBLE CHOICES :	8 digits max.	
SEE ALSO :	See section 6.1 and the classification in section 7.1.	
NOTE:	The instrument is shipped with password #1 = blank (No entry) This gives a full access to configuration. (No protection)	
NOTICE :	If PSSWRD #1 = PSSWRD #2 , the password will be understood as PSSWRD #2 . If PSSWRD#1 = PSSWRD#2 = blank , no password will be asked for configuration access. Do not lose your password code. If yes, you have to contact your service department.	

7. DETAILED CONFIGURATION

<i>FUNCTION</i>	<i>PARAMETER</i>	<i>CLASSIFICATION</i>
MISCEL	PSSWRD 2	◆
DEFINITION :	Used to provide a full access to configuration.	
HOW TO MODIFY IT :	Enter a text.	
POSSIBLE CHOICES :	8 digits max.	
SEE ALSO :	See section 6.1 and the classification in section 7.1.	
NOTE:	The instrument is shipped with password #2 = blank (No entry) This gives a full access to configuration. (No protection)	
NOTICE :	<p>If PSSWRD #2 = PSSWRD #1, the password will be understood as PSSWRD #2.</p> <p>If PSSWRD#2 = PSSWRD#1 = blank, no password will be asked for configuration access.</p> <p>Do not lose your password code. If yes, you have to contact your service department.</p>	

7. DETAILED CONFIGURATION

<i>FUNCTION</i>	<i>PARAMETER</i>	<i>CLASSIFICATION</i>
MISCEL	MATH PAK	◆
DEFINITION :	Type of optional math package	
HOW TO MODIFY IT :	Enter a code.	
POSSIBLE CHOICES :	: Up to 12 digits	
SEE ALSO :	SEE MATH USER'S MANUAL	
NOTICE:	<p>This code should be delivered by your service department and is specific to this recorder.</p> <p>To obtain a new code, please indicate the full serial number displayed on MMI. (See the section 8 "SERVICE" on page 8-16)</p>	
<i>FUNCTION</i>	<i>PARAMETER</i>	<i>CLASSIFICATION</i>
MISCEL	USE CONF	◆
DEFINITION :	Selection of the desired configuration number.	
HOW TO MODIFY IT :	Select the configuration number.	
POSSIBLE CHOICES :	5 CONF ONE CONF TWO	
NOTE :	When CONF # changes, the previous configuration is automatically saved.	

7. DETAILED CONFIGURATION

FUNCTION



BATCH

PARAMETERS



START



RESET



BATCH #



BACKUP



LINE 1



LINE 2



LINE 3



LINE 4

7. DETAILED CONFIGURATION

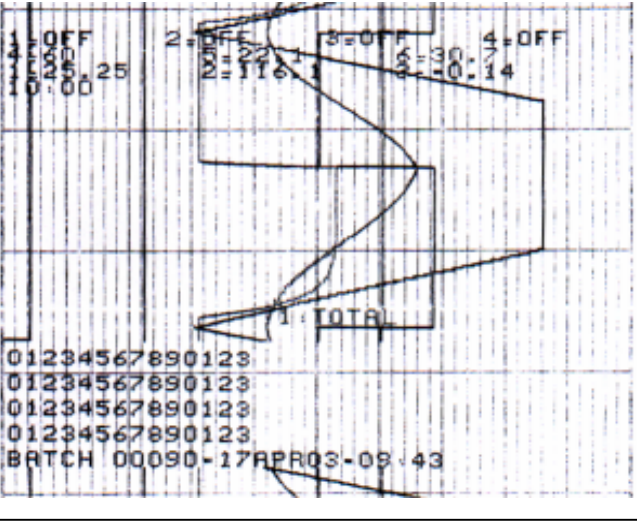
<i>FUNCTION</i>	<i>PARAMETER</i>	<i>CLASSIFICATION</i>
BATCH	START	◆
DEFINITION :	BATCH ACTIVATION CONDITION	
HOW TO MODIFY IT :	The START condition defines when batch printing must start. The recorder pauses each time the start condition occurs and then prints the batch description and increments the batch number.	
POSSIBLE VALUES :	DIG 1 CLOSED DIG 2 CLOSED DIG 3 CLOSED DIG 4 CLOSED CONTINUOUSLY	
		
NOTE:	If the logic input drives both restart chart advance (exit of stop chart advance) and printing Batch. We have to choose into the DIGITAL matrix parameter, PRINT MESSAGE = NONE in order to print whole messages of the Batch	

7. DETAILED CONFIGURATION

<i>FUNCTION</i>	<i>PARAMETER</i>	<i>CLASSIFICATION</i>
BATCH	RESET	◆
DEFINITION :	BATCH NUMBER RESET CONDITION The RESET condition defines when the batch number must reset.	
HOW TO MODIFY IT :	Select a new digital input.	
POSSIBLE CHOICES :	DIG 1 OPEN DIG 2 OPEN DIG 3 OPEN DIG 4 OPEN NO RESET	
<i>FUNCTION</i>	<i>PARAMETER</i>	<i>CLASSIFICATION</i>
BATCH	BATCH	◆
DEFINITION :	Batch number used after a reset condition.	
HOW TO MODIFY IT :	Enter a new value.	
POSSIBLE CHOICES :	[0 ... 65535]	

7. DETAILED CONFIGURATION

<i>FUNCTION</i>	<i>PARAMETER</i>	<i>CLASSIFICATION</i>
BATCH	BACKUP	◆
DEFINITION :	Store the batch number in case of power interruption.	
HOW TO MODIFY IT :	Choose a new selection.	
POSSIBLE CHOICES :	ENABLE DISABLE	
<i>FUNCTION</i>	<i>PARAMETER</i>	<i>CLASSIFICATION</i>
BATCH	LINE 1	◆
DEFINITION :	Configuration of the first line of the batch message.	
HOW TO MODIFY IT :	Enter the text of the first line.	
POSSIBLE CHOICES :	14 characters max.	
SEE ALSO	Lines 2, 3 and 4 in this function.	

7. DETAILED CONFIGURATION

<i>FUNCTION</i>	<i>PARAMETER</i>	<i>CLASSIFICATION</i>
BATCH	LINE 2	◆
DEFINITION :	Configuration of the second line of the batch message.	
HOW TO MODIFY IT :	Enter the text of the second line.	
POSSIBLE CHOICES :	14 characters.	
SEE ALSO	Lines 3 and 4 in this function.	
<i>FUNCTION</i>	<i>PARAMETER</i>	<i>CLASSIFICATION</i>
BATCH	LINE 3	◆
DEFINITION :	Configuration of the third line of the batch message.	
HOW TO MODIFY IT :	Enter the text of the third line.	
POSSIBLE CHOICES :	14 characters.	
SEE ALSO	Line 4 in this function.	

7. DETAILED CONFIGURATION

<i>FUNCTION</i>	<i>PARAMETER</i>	<i>CLASSIFICATION</i>
BATCH	LINE 4	◆
<i>DEFINITION :</i>	Configuration of the fourth line of the batch message.	
<i>HOW TO MODIFY IT :</i>	Enter the text of the fourth line.	
<i>POSSIBLE CHOICES :</i>	14 characters.	

7. DETAILED CONFIGURATION

FUNCTION



PRINTER

PARAMETERS



CHART LG



SPD UNIT



SPEED1



SPEED2



SPD USED



TABULAR1



TABULAR2



REC MODE



PRT MODE



PRT INTV



PRINT PV



PRT RANG



PRT TIME



PRT TAG



PEN OFFS

7. DETAILED CONFIGURATION

<i>FUNCTION</i>	<i>PARAMETER</i>	<i>CLASSIFICATION</i>
PRINTER	CHART LG	◆
DEFINITION :	Total chart length of the chart roll or fanfold	
HOW TO MODIFY IT :	Enter length of new chart.	
POSSIBLE VALUES :	[0 ... 30000] mm [0 ... 1181.1] inch Refer to SPEED unit to know the unit in use.	
SEE ALSO	TYPE in EVENT matrix.	
NOTICE :	Chart roll length : 24 m or 945 inch Chart fanfold length : 18 m or 709 inch	
<i>FUNCTION</i>	<i>PARAMETER</i>	<i>CLASSIFICATION</i>
PRINTER	SPD UNIT	◆
DEFINITION :	Speed unit	
HOW TO MODIFY IT :	Select a new value.	
POSSIBLE CHOICES :	UNIT = mm/h or UNIT = inch/h	

7. DETAILED CONFIGURATION

<i>FUNCTION</i>	<i>PARAMETER</i>	<i>CLASSIFICATION</i>
PRINTER	SPEED 1	◆◆
DEFINITION :	Value of speed 1.	
HOW TO MODIFY IT :	Enter a numeric value based on speed unit selected. .	
POSSIBLE VALUES :	With mm/h unit : [1 ... 1500] for a multipoint recorder [1 ... 6000] for a pen recorder or With inch/h unit : [0.039 ... 59] for a multipoint recorder [0.039 ... 237] for a pen recorder Refer to SPD UNIT to know the speed unit in use.	
NOTICE:	A fast chart speed may affect the printing performance	
	<div style="text-align: center;"> <p>PEN RECORDER WRITING SPEED</p> <p> ① Chart fully documented ② No chart scales ③ Traces only </p> </div>	

7. DETAILED CONFIGURATION

FUNCTION	PARAMETER	CLASSIFICATION
PRINTER	SPEED 1	◆◆
<p>MULTIPOINT RECORDER WRITING SPEED</p> <p>Number of distinct lines</p> <p>① Continuous traces in color with regular chart documentation</p> <p>② Dotted traces in color with regular chart documentation</p> <p>③ Dotted traces in color without periodic messages Alarm messages are printed.</p>		

7. DETAILED CONFIGURATION

<i>FUNCTION</i>	<i>PARAMETER</i>	<i>CLASSIFICATION</i>
PRINTER	SPEED 2	◆
<i>DEFINITION :</i>	Value of speed 2.	
<i>HOW TO MODIFY IT :</i>	Enter a numeric value based on speed unit selected. .	
<i>POSSIBLE VALUES :</i>	With mm/h unit : [1 ... 1500] for a multipoint recorder [1 ... 6000] for a pen recorder or With inch/h unit : [0.039 ... 59] for a multipoint recorder [0.039 ... 237] for a pen recorder Refer to SPD UNIT to know the speed unit in use.	
<i>NOTICE:</i>	A fast chart speed may affect the printing performance	

7. DETAILED CONFIGURATION

<i>FUNCTION</i>	<i>PARAMETER</i>	<i>CLASSIFICATION</i>
PRINTER	SPEED 2	◆
<p>MULTIPOINT RECORDER WRITING SPEED</p> <p>Number of defined lines</p> <p> 1 Continuous traces in color with regular chart documentation 2 Dotted traces in color with regular chart documentation a Dotted traces in color without periodic messages. Alarm messages are printed. </p>		

7. DETAILED CONFIGURATION

<i>FUNCTION</i>	<i>PARAMETER</i>	<i>CLASSIFICATION</i>
PRINTER	SPD USED	◆
<i>DEFINITION :</i>	Defines speed in use.	
<i>HOW TO MODIFY IT :</i>	Select a new speed. .	
<i>POSSIBLE CHOICES :</i>	SPEED 1 USED SPEED 2 USED	
<i>NOTE:</i>	If printing mode (PRT MODE) is TABULAR , SPEED 1 , SPEED 2 must be understood as TABULAR 1 , TABULAR 2 .	

7. DETAILED CONFIGURATION

<i>FUNCTION</i>	<i>PARAMETER</i>	<i>CLASSIFICATION</i>
PRINTER	TABULAR 1	◆
<i>DEFINITION :</i>	Tab 1 prints interval. (In minute)	
<i>HOW TO MODIFY IT :</i>	Select a new time. .	
<i>POSSIBLE CHOICES :</i>	10 mn 20 mn 30 mn 1 Hour 2 Hours 3 Hours 4 Hours 8 Hours 24 Hours	
<i>SEE ALSO:</i>	PRT MODE in this function.	
<i>NOTICE :</i>	THIS FUNCTION IS ONLY AVAILABLE FOR MULTIPOINT RECORDERS.	

7. DETAILED CONFIGURATION

<i>FUNCTION</i>	<i>PARAMETER</i>	<i>CLASSIFICATION</i>
PRINTER	TABULAR 2	◆
<i>DEFINITION :</i>	Tab 2 prints interval. (In minute)	
<i>HOW TO MODIFY IT :</i>	Select a new time. .	
<i>POSSIBLE CHOICES :</i>	10 mn 20 mn 30 mn 1 Hour 2 Hours 3 Hours 4 Hours 8 Hours 24 Hours	
<i>SEE ALSO:</i>	PRT MODE in this function.	
<i>NOTICE :</i>	THIS FUNCTION IS ONLY AVAILABLE FOR MULTIPOINT RECORDERS.	

7. DETAILED CONFIGURATION

<i>FUNCTION</i>	<i>PARAMETER</i>	<i>CLASSIFICATION</i>																
PRINTER	REC MODE	◆																
DEFINITION :	Recording mode allows you to print normally, to stop the printer, to trigger the printer on alarm with (or without) return to stand-by.																	
HOW TO MODIFY IT :	Select a new value.																	
POSSIBLE CHOICES :	<p>INHIBIT</p> <p>PRINT</p> <p>FOR MULTIPOINT RECORDERS ONLY :</p> <p>EVPR RT STBY : triggering of "Event precursor" when alarm occurs with return to standby.</p> <p>EVPR RT RUN : triggering of "Event precursor" when alarm occurs followed by continuous recording.</p>																	
NOTE:	<p>If EVPR is selected, the brightness of the display decreases.</p> <p>Historic = chart length printed = 5 cm</p> <table border="1" style="margin-left: auto; margin-right: auto;"> <thead> <tr> <th style="text-align: center;">Chart speed</th> <th style="text-align: center;">Historic time</th> </tr> </thead> <tbody> <tr> <td style="text-align: center;">10</td> <td style="text-align: center;">300 mn (5 h.)</td> </tr> <tr> <td style="text-align: center;">50</td> <td style="text-align: center;">60 mn (1 h.)</td> </tr> <tr> <td style="text-align: center;">100</td> <td style="text-align: center;">30 mn (1/2 h.)</td> </tr> <tr> <td style="text-align: center;">250</td> <td style="text-align: center;">12 mn</td> </tr> <tr> <td style="text-align: center;">500</td> <td style="text-align: center;">6 mn</td> </tr> <tr> <td style="text-align: center;">1000</td> <td style="text-align: center;">3 mn</td> </tr> <tr> <td style="text-align: center;">1500</td> <td style="text-align: center;">2 mn</td> </tr> </tbody> </table>		Chart speed	Historic time	10	300 mn (5 h.)	50	60 mn (1 h.)	100	30 mn (1/2 h.)	250	12 mn	500	6 mn	1000	3 mn	1500	2 mn
Chart speed	Historic time																	
10	300 mn (5 h.)																	
50	60 mn (1 h.)																	
100	30 mn (1/2 h.)																	
250	12 mn																	
500	6 mn																	
1000	3 mn																	
1500	2 mn																	
NOTICE:	<p>EVPR RT STBY and EVPR RT RUN are only active if PRT MODE is equal to TREND.</p> <p>The selection of INHIBIT takes priority over PRINT INHIBIT requested on ALARM or with BASIC ACTIONS.</p> <p>When recorder is configured with INHIBIT : the messages, the PV printout and the batch messages are not printed neither at the beginning of INHIBIT mode nor at the end.</p>																	

7. DETAILED CONFIGURATION

<i>FUNCTION</i>	<i>PARAMETER</i>	<i>CLASSIFICATION</i>
PRINTER	PRT MODE	◆◆
DEFINITION :	Under this heading you must choose whether recording will be in trend mode or tabular mode.	
HOW TO MODIFY IT :	Select a new printing mode. .	
POSSIBLE CHOICES :	TREND : All channels recorded as trends. TABULAR : All channels recorded in tabular format.	
SEE ALSO:	REC MODE for compatibility with EVENT PERCURSOR .	
NOTICE:	THIS FUNCTION IS ONLY AVAILABLE FOR MULTIPOINT RECORDERS.	

7. DETAILED CONFIGURATION

<i>FUNCTION</i>	<i>PARAMETER</i>	<i>CLASSIFICATION</i>
PRINTER	PRT INTV	◆
DEFINITION :	Separation (in millimeters) of PRT PV interval for periodic printing.	
HOW TO MODIFY IT :	Select a new printing interval. .	
POSSIBLE CHOICES :	60 mm 120 mm 240 mm 480 mm	
NOTE:	<p>The distance between 2 periodic chart documentation is approximate. The software will print at the round time as closest as possible to the selected distance value.</p> <p>Between the periodic printing of PV, chart ranges informations and speed/time informations may be printed if they are selected and if PRT INTV is larger than 60 mm.</p>	

7. DETAILED CONFIGURATION

<i>FUNCTION</i>	<i>PARAMETER</i>	<i>CLASSIFICATION</i>
PRINTER	PRINT PV	◆
DEFINITION :	Periodic printing of PV values, times and digital input status.	
HOW TO MODIFY IT :	: Choose a new selection. .	
POSSIBLE CHOICES :	ENABLE DISABLE	
SEE ALSO:	PRT INTV in this function.	

7. DETAILED CONFIGURATION

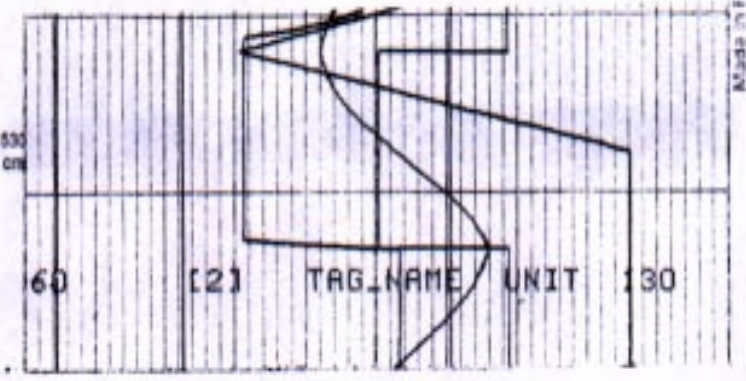
<i>FUNCTION</i>	<i>PARAMETER</i>	<i>CLASSIFICATION</i>
PRINTER	PRINT RANGE	◆
DEFINITION :	Periodic printing of the chart ranges.	
HOW TO MODIFY IT :	Select a new selection. .	
POSSIBLE CHOICES :	ENABLE DISABLE	
SEE ALSO:	PRT INTV in this function.	
		

7. DETAILED CONFIGURATION

<i>FUNCTION</i>	<i>PARAMETER</i>	<i>CLASSIFICATION</i>
PRINTER	PRINT TIME	◆
DEFINITION :	Periodic printing of "TIME, SPEED AND CHANNEL ID".	
HOW TO MODIFY IT :	Select a new selection. .	
POSSIBLE CHOICES :	ENABLE DISABLE	
SEE ALSO:	PRT INTV in this function.	

7. DETAILED CONFIGURATION

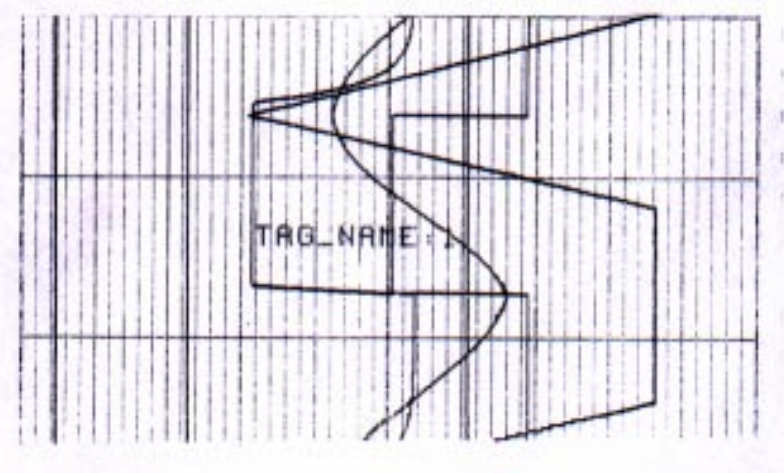
<i>FUNCTION</i>	<i>PARAMETER</i>	<i>CLASSIFICATION</i>
PRINTER	PRINT TAG	◆
DEFINITION :	Periodic printing of the tag name with the chart number message.	
HOW TO MODIFY IT :	Choose a new selection. .	
POSSIBLE CHOICES :	ENABLE DISABLE	
NOTICE:	This function is only available for multipoint recorder.	
		

7. DETAILED CONFIGURATION

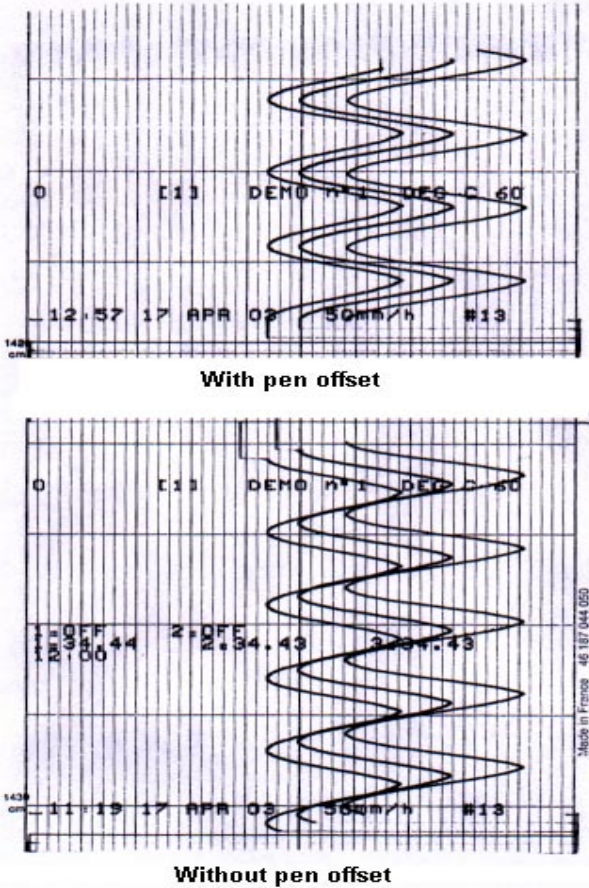
FUNCTION	PARAMETER	CLASSIFICATION
PRINTER	PEN OFFS	◆
DEFINITION :	Pen offset.	
HOW TO MODIFY IT :	Choose a new selection.	
POSSIBLE CHOICES :	OFF ON	
NOTICE:	THIS FUNCTION IS ONLY AVAILABLE FOR PEN RECORDERS.	
	 <p style="text-align: center;">With pen offset</p> <p style="text-align: center;">Without pen offset</p>	

7. DETAILED CONFIGURATION

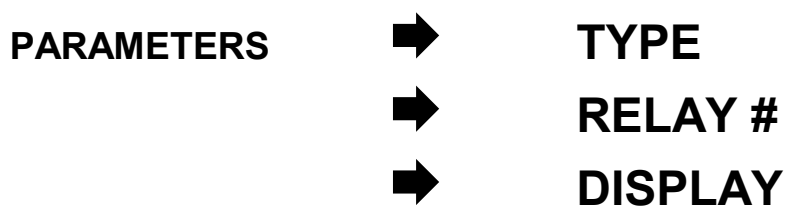
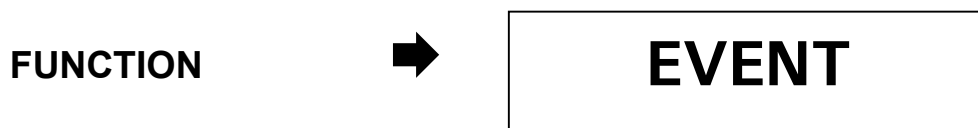

<i>FUNCTION</i>	<i>PARAMETER</i>	<i>CLASSIFICATION</i>
EVENT	TYPE	◆
<i>DEFINITION :</i>	Type of event.	
<i>HOW TO MODIFY IT :</i>	NOT POSSIBLE ➡ CASSETTE OUT ➡ END PAPER ➡ BATTERY ➡ ALARM (analog alarm) ➡ BURNOUT ➡ SHEDTIME	

7. DETAILED CONFIGURATION

<i>FUNCTION</i>	<i>PARAMETER</i>	<i>CLASSIFICATION</i>
EVENT	RELAY #	◆
DEFINITION :	Selection of relay activated in event condition.	
HOW TO MODIFY IT :	Select a new relay number.	
POSSIBLE CHOICES :	NO RELAY RELAY 1 RELAY 2 RELAY 3 RELAY 4 RELAY 5 RELAY 6 RELAY 7 RELAY 8 RELAY 9 RELAY 10 RELAY 11 RELAY 12	
<i>FUNCTION</i>	<i>PARAMETER</i>	<i>CLASSIFICATION</i>
EVENT	DISPLAY	◆
DEFINITION :	Enable/disable a display warning in event occurrence.	
HOW TO MODIFY IT :	Choose a new selection.	
POSSIBLE CHOICES :	ENABLE DISABLE	
NOTE	Burnout event cannot be displayed for sensors and ranges with "Fix Burnouts". (See analog matrix, Burnout parameter.)	

FUNCTION



MMI

PARAMETERS



KEY DOWN



KEY UP



KEY LEFT



KEY RIGH



DISPLAY



BRIGHT

7. DETAILED CONFIGURATION

<i>FUNCTION</i>	<i>PARAMETER</i>	<i>CLASSIFICATION</i>
MMI	KEY DOWN	◆
DEFINITION :	To modify the display indication in normal operation.	
HOW TO MODIFY IT :	Choose a new selection.	
POSSIBLE CHOICES :	ENABLE DISABLE	
NOTE	The possible indications are : - Analog input - Comm - Math - Chart traces - Tag and traces - Bargraph A - Bargraph B (FOR 2 OR 3 PEN RECORDERS ONLY) - Date/time - Chart speed - Alarm status	
<i>FUNCTION</i>	<i>PARAMETER</i>	<i>CLASSIFICATION</i>
MMI	KEY UP	◆
DEFINITION :	To stop the display scanning in normal operation.	
HOW TO MODIFY IT :	Select a new selection.	
POSSIBLE CHOICES :	ENABLE DISABLE	
NOTE	The possible actions are : - Scan - Hold	

7. DETAILED CONFIGURATION

<i>FUNCTION</i>	<i>PARAMETER</i>	<i>CLASSIFICATION</i>
MMI	KEY LEFT	◆
DEFINITION :	To modify the printer operation.	
HOW TO MODIFY IT :	Choose a new selection	
POSSIBLE CHOICES :	ENABLE DISABLE	
NOTE	The possible actions are : - Print date/time - Digital print out - Chart hold - Chart run - Change Speed/Tab - Chart advance - Reset chart length	
<i>FUNCTION</i>	<i>PARAMETER</i>	<i>CLASSIFICATION</i>
MMI	KEY	◆
DEFINITION :	To reset the maths functions or batch number.	
HOW TO MODIFY IT :	Choose a new selection.	
POSSIBLE CHOICES :	ENABLE DISABLE	
NOTE	The possible actions are : - Reset Math [1 ... 6] - Reset Math All - Reset batch number and alarm occurrence value - Reset increment batch number and alarm occurrence value	

7. DETAILED CONFIGURATION

<i>FUNCTION</i>	<i>PARAMETER</i>	<i>CLASSIFICATION</i>
MMI	DISPLAY	◆◆◆
DEFINITION :	Type of information to display in run mode at power on.	
HOW TO MODIFY IT :	Choose a new selection.	
POSSIBLE CHOICES :	1 BARGRAPH 2 BARGRAPH B (FOR PEN MODEL) TRACE TRACE & TAG ANALOG INPUT MATH RESULTS COMM INPUTS (If option is present) ALARMS SPEED IN USE DATE & TIME	
SEE ALSO:	Section 3 "OPERATION"	

<i>FUNCTION</i>	<i>PARAMETER</i>	<i>CLASSIFICATION</i>
MMI	BRIGHT	◆
DEFINITION :	To modify the display brightness during operation.	
HOW TO MODIFY IT :	Choose a new selection.	
POSSIBLE CHOICES :	OFF (0 %) >> (20 %) MEDIUM (40 %) >> (60 %) >> (80 %) HIGH (100 %)	

7. DETAILED CONFIGURATION

FUNCTION



CUR OUT

PARAMETERS



CH #



LOW VAL



HIGH VAL

<i>FUNCTION</i>	<i>PARAMETER</i>	<i>CLASSIFICATION</i>
CUR OUT	CH #	◆
DEFINITION :	Defines the variable to apply on current output. (Analog input 1...6, Comm 1...6, Math 1...6, None)	
HOW TO MODIFY IT :	Select a new value.	
POSSIBLE CHOICES :	<p>NONE</p> <p>ANALOG 1 ANALOG 2 ANALOG 3 ANALOG 4 ANALOG 5 ANALOG 6</p> <p>COMM 1 COMM 2 COMM 3 COMM 4 COMM 5 COMM 6</p> <p>MATH 1 MATH 2 MATH 3 MATH 4 MATH 5 MATH 6</p>	

7. DETAILED CONFIGURATION

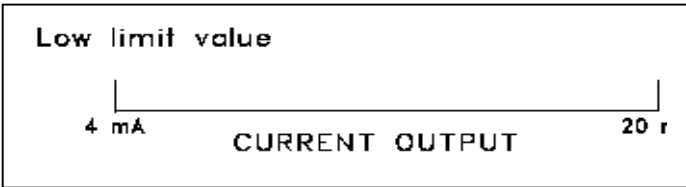
<i>FUNCTION</i>	<i>PARAMETER</i>	<i>CLASSIFICATION</i>
CUR OUT	LOW VAL	◆
DEFINITION :	Engineering value corresponding to a 4 mA output signal.	
HOW TO MODIFY IT :	Enter a numeric value..	
POSSIBLE CHOICES :	Up to 5 digits for analog inputs, communication inputs. Up to 8 digits for mathematic results. Including negative sign and decimal points.	
EXAMPLE :		
NOTICE :	Do not use more than 5 digits for analog inputs and communication inputs.	

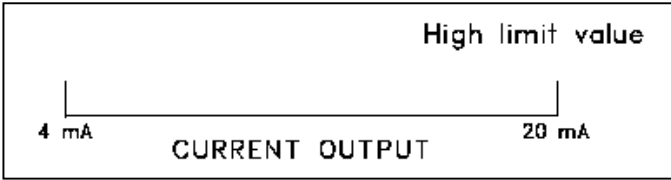
<i>FUNCTION</i>	<i>PARAMETER</i>	<i>CLASSIFICATION</i>
CUR OUT	HIGH VAL	◆
DEFINITION :	Engineering value corresponding to a 20 mA output signal.	
HOW TO MODIFY IT :	Enter a numeric value..	
POSSIBLE CHOICES :	Up to 5 digits for analog inputs, communication inputs. Up to 8 digits for mathematic results. Including negative sign and decimal points.	
EXAMPLE :		
NOTICE:	Do not use more than 5 digits for analog inputs and communication inputs.	

8.1 OPERATOR INTERFACE

8.1.1 ACCESS TO SERVICE

Access to Read/Write Configuration (R/W), Print Configuration (PRN) of service (SRV) from Operation mode is obtained by pressing the SETUP key.

8.1.2 PASSWORDS

To protect the recorder against unauthorized access, the operator has to enter a password. There are two possible levels of access :

- 2 Password #1 allows reduced access to service. If password #1 is used, you are able only to adjust the 0 % and 100 % chart markings.
- 2 Password #2 allows full access to service.

8.1.3 MAIN FUNCTION

The main function consists of 3 operation modes x 14 functions. Once inside the function selections, it is possible to move in any direction within them by means of the four ▲ ▼ ◀ ▶ keys.

Use of the ▲ ▼ keys allows you to select SRV for service.

Use if the ◀ ▶ keys allows you to select one of the following function of parameters for SERVICE action :

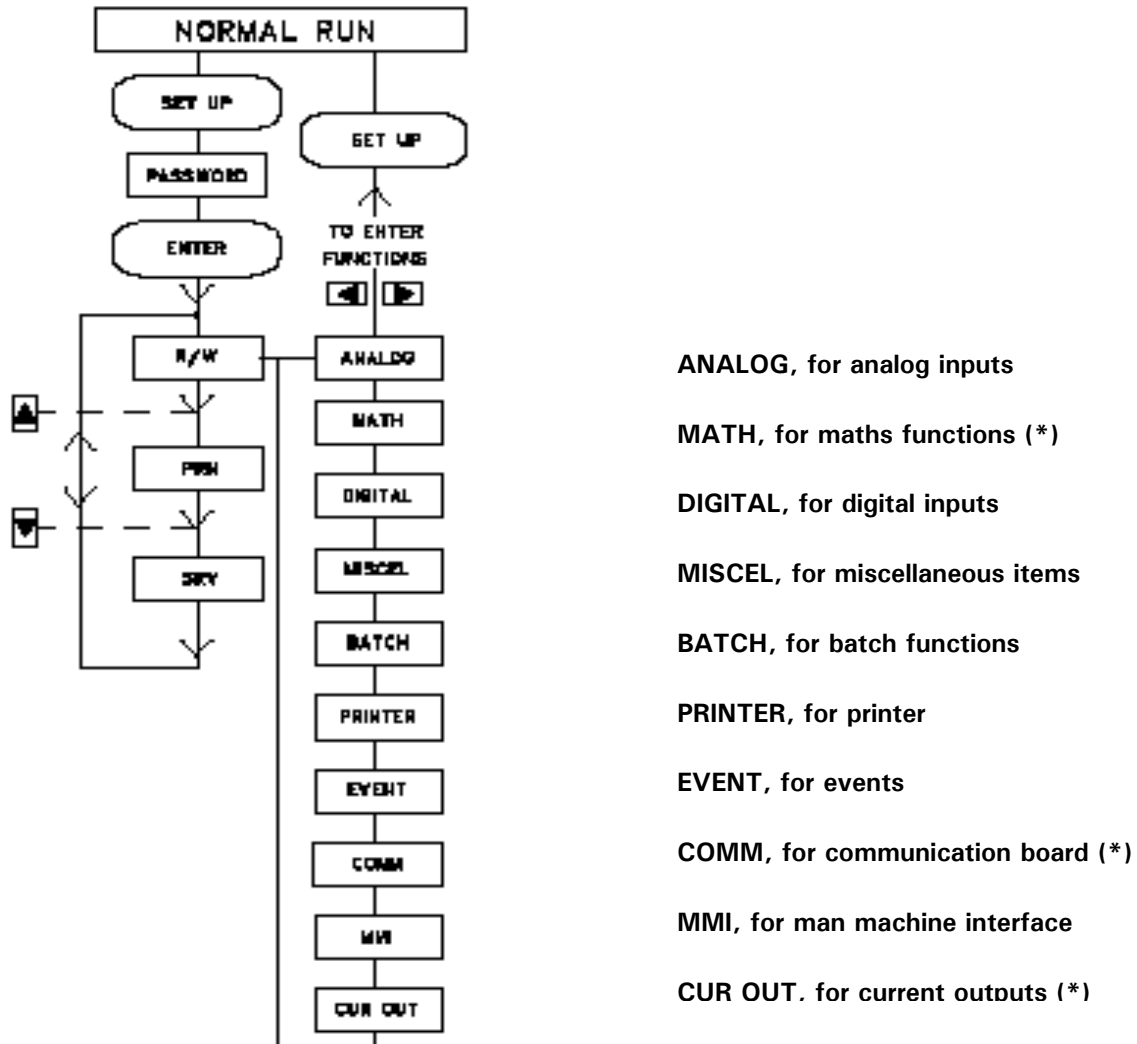

(*) The function appears only if the corresponding option is present.
 Press ENTER to validate your selection, or press SETUP to come back to main function.

8.1.4 ACCESS TO FUNCTIONS DURING SERVICE

TYPES OF SERVICE SELECTION :

The ◀ ▶ keys allows you to select the type of service you want to execute.

The ▲ ▼ keys allows you to select the channel on which you want to execute the service.
 Press ENTER to validate your selection, or press SETUP to come back to main function.

8.2 LIST OF SERVICES

- ➔ ANALOG**
- ➔ MATH**
- ➔ DIGITAL**
- ➔**
- ➔ MISCEL**
- ➔**
- ➔ BATCH**
- ➔**
- ➔ PRINTER**
- ➔**
- ➔ EVENT**
- ➔**
- ➔ MMI**
- ➔**
- ➔ CUR OUT**

FUNCTION ➡

ANALOG

PARAMETERS ➡ **PV CALIB**
 ➡ **JUNCT T o**
 ➡ **CAL DATE**
 ➡ **JUNCT o C**

8. SERVICE

FUNCTION									
ANALOG	PV CALIB								
DEFINITION :	Allows the user to calibrate the 0% and 100% of the measure system.								
HOW TO USE/EXECUTE IT :	<p>The message "1 (channel) CAL 0%" is flashing with "CONNECT 0%". (Asks the user to prepare the system for the 0% calibration). Set input generator to deliver a signal corresponding to low scale (0%).</p> <p>NOTICE: Precision is inherently low for a few thermocouples at low temperatures. For these thermocouples, the low calibration point (CAL 0%) has been shifted :</p> <table data-bbox="646 856 1088 982"><tr><td>Thermocouple</td><td>CAL 0%</td></tr><tr><td>PR20-40</td><td>1100oC = 2012oF</td></tr><tr><td>B</td><td>600oC = 1112oF</td></tr><tr><td>WW26</td><td>400oC = 752oF</td></tr></table> <p>Then press ENTER, calibration starts and "CAL 0%" is flashing. You can press SETUP at any time to cancel the process.</p> <p>Then the message "CAL 100%" flashing with "CONNECT 100%" asks the user to prepare the recorder for the 100% calibration.</p> <p>Set input generator to deliver a signal corresponding to full scale (100%).</p> <p>Then press ENTER, the 100% calibration starts and "CAL 100%" is flashing. You can press SETUP at any time to cancel the process.</p> <p>If you don't cancel the calibration (0% or 100%), "END CAL" is displayed for 3 seconds. Press SETUP to exit.</p>	Thermocouple	CAL 0%	PR20-40	1100oC = 2012oF	B	600oC = 1112oF	WW26	400oC = 752oF
Thermocouple	CAL 0%								
PR20-40	1100oC = 2012oF								
B	600oC = 1112oF								
WW26	400oC = 752oF								
NOTE :	Instrument should be allowed to warm up for period of 30 minutes before calibration.								
NOTICE :	Signal generators should have an accuracy of at least 0.05 %.								

8. SERVICE

<i>FUNCTION</i>	<i>TYPE OF SERVICE</i>
ANALOG	JUNCT T °
DEFINITION :	Allows the user to calibrate the cold junction temperature.
HOW TO USE/EXECUTE IT :	<p>When you enter in the sub-matrix, the message "1T: 25.1 oC" is displayed. Press \square or \square, to modify the current value.</p> <p>Press ENTER to accept this value, or ESC to cancel.</p> <p>If you accept, the calibration of the cold junction is executed.</p> <p>The message "CAL JUNCT" is flashing during few seconds. You can cancel the process by pressing ESC.</p> <p>If you don't cancel, the message "END CAL." is displayed for three seconds.</p>
NOTE :	<p>All units are delivered with the cold junction temperature already calibrated.</p> <p>This action is required only if the input card is changed or modified.</p>

8. SERVICE

<i>FUNCTION</i>	<i>TYPE OF SERVICE</i>
ANALOG	CAL DATE
DEFINITION :	Shows you the date of the last PV calibration or junction calibration.
HOW TO USE/EXECUTE IT :	You can only read the date. Press SETUP to escape.
<i>FUNCTION</i>	<i>TYPE OF SERVICE</i>
ANALOG	JUNCT °C
DEFINITION :	Shows value of the cold junction compensation voltage.
HOW TO USE/EXECUTE IT :	You can only read the value. Press SETUP to escape.
NOTE :	Value in °C.

FUNCTION ➔ **MATH**

PARAMETERS ➔ **TIMER**

<i>FUNCTION</i>	<i>TYPE OF SERVICE</i>
MATH	TIMER
DEFINITION :	Displays the current value of timers used for math functions.
HOW TO USE/EXECUTE IT :	You can only read the value. Press SETUP to escape.

FUNCTION



DIGITAL

PARAMETERS



STATUS

<i>FUNCTION</i>	<i>TYPE OF SERVICE</i>
DIGITAL	STATUS
<i>DEFINITION :</i>	Displays the status of digital input.
<i>HOW TO USE/EXECUTE IT :</i>	You can only read the value. Press SETUP to escape.

FUNCTION



MISCEL

PARAMETERS



SERIAL



FNL TEST



HARDWARE



SOFTWARE



BACKUP



RESTORE

8. SERVICE

<i>FUNCTION</i>	<i>TYPE OF SERVICE</i>
MISCEL	SERIAL #
<i>DEFINITION :</i>	Shows the serial number.
<i>HOW TO USE/EXECUTE IT :</i>	You can only read the value. Press SETUP to escape.
<i>FUNCTION</i>	<i>TYPE OF SERVICE</i>
MISCEL	FNL TEST
<i>DEFINITION :</i>	Shows the date of final factory test.
<i>HOW TO USE/EXECUTE IT :</i>	You can only read the value. Press SETUP to escape.
<i>FUNCTION</i>	<i>TYPE OF SERVICE</i>
MISCEL	HARDWARE
<i>DEFINITION :</i>	Shows the recorder hardware version.
<i>HOW TO USE/EXECUTE IT :</i>	You can only read the value. Press SETUP to escape.

8. SERVICE

<i>FUNCTION</i>	<i>TYPE OF SERVICE</i>
MISCEL	SOFTWARE
<i>DEFINITION :</i>	Shows the recorder software version.
<i>HOW TO USE/EXECUTE IT :</i>	You can only read the value. Press SETUP to escape.
<i>FUNCTION</i>	<i>TYPE OF SERVICE</i>
MISCEL	BACKUP
<i>DEFINITION :</i>	Saves time, date, remaining paper length, math results before changing the battery.
<i>HOW TO USE/EXECUTE IT :</i>	When you press ENTER in the function, the copy is executed.
<i>NOTE</i>	You can execute several backup before restoring the values. But you can not execute many restores without any backup.
<i>FUNCTION</i>	<i>TYPE OF SERVICE</i>
MISCEL	RESTORE
<i>DEFINITION :</i>	Restores the previous backup values after having changed the battery.
<i>HOW TO USE/EXECUTE IT :</i>	When you press ENTER in the function, the recorder resets.

FUNCTION → **BATCH**

PARAMETERS → **BATCH #**

<i>FUNCTION</i>	<i>TYPE OF SERVICE</i>
BATCH	BATCH
<i>DEFINITION :</i>	Displays the batch number.
<i>HOW TO USE/EXECUTE IT :</i>	You can only read the value. Press SETUP to escape.

FUNCTION → **PRINTER**

PARAMETERS → **CHART LG**
→ **0% CHART**
→ **100% CHT**
→ **CHARACTR**

8. SERVICE

<i>FUNCTION</i>	<i>TYPE OF SERVICE</i>
PRINTER	CHART LG
DEFINITION :	Allows the user to know the length of remaining chart.
HOW TO USE/EXECUTE IT :	You can only read the value. Press SETUP to escape.
<i>FUNCTION</i>	<i>TYPE OF SERVICE</i>
PRINTER	0% CHART
DEFINITION :	Chart certification to show the current 0% chart position with 0% print carriage. This is a mechanical adjustment.
HOW TO USE/EXECUTE IT :	The message "(channel nb) CAL 0% " with a flashing number. This number corresponds to the present adjustment (= step motor). To move to the right, increase this number or to the left, decrease the number. (You may introduce a negative number.) You can change the distance value by pressing the ▲ ▼ keys. You accept the value by pressing ENTER. You can leave the 0% chart service by pressing SETUP
NOTE :	When you press ENTER, the head moves and prints at the new 0% chart calibration.

8. SERVICE

<i>FUNCTION</i>	<i>TYPE OF SERVICE</i>
PRINTER	100% CHT
DEFINITION :	Chart certification to show the current 100% chart position with 100% print carriage. This is a mechanical adjustment.
HOW TO USE/EXECUTE IT :	The message "(channel nb) CAL 100% " with a flashing number. This number corresponds to the present adjustment (= step motor). To move to the right, increase this number or to the left, decrease the number. (You may introduce a negative number.) You can change the distance value by pressing the ▲ ▼ keys. You accept the value by pressing ENTER. You can leave the 100% chart service by pressing SETUP.
NOTE :	When you press ENTER, the head moves and prints at the new 100% chart calibration.
<i>FUNCTION</i>	<i>TYPE OF SERVICE</i>
PRINTER	CHARACTR
DEFINITION :	Prints all the characters available with the printer.
HOW TO USE/EXECUTE IT :	The printer test begins when you enter in the function. You stop it by pressing SETUP.
NOTE :	Lines of 12 characters are printed.

FUNCTION



EVENT

PARAMETERS



EV STATE

<i>FUNCTION</i>	<i>TYPE OF SERVICE</i>
EVENT	EV STATE
DEFINITION :	Shows the event status.
HOW TO USE/EXECUTE IT :	You can only read the event status. Press SETUP to escape.

FUNCTION



MMI

PARAMETERS



DIS TEST

<i>FUNCTION</i>	<i>TYPE OF SERVICE</i>
MMI	DIS TEST
DEFINITION :	Confirm that the display is operating correctly.
HOW TO USE/EXECUTE IT :	When you enter in the function, every pixel flashes for 15 seconds. You can stop it by pressing SETUP.

FUNCTION



CUR OUR

PARAMETERS



CUR 0%



CUR 100%

<i>FUNCTION</i>	<i>TYPE OF SERVICE</i>
CUR OUT	CUR 0%
DEFINITION :	Allows the user to calibrate the 0% of the current output channel number. (Use a mA meter for this calibration)
HOW TO USE/EXECUTE IT :	The message "(output nb) CUR 0% " with a 0 flashing. You can change the current output value by pressing the ▲ ("+" flashing) ▼ ("- " flashing) keys. You accept the current output by pressing ENTER. You can leave the 0% current output service by pressing SETUP
NOTE :	When you press ENTER, the new 0% (4mA) current reference is stored in the recorder EEPROM memory. The recorder should be allowed to warm up for period of 1 hour before the current output calibration.

8. SERVICE

<i>FUNCTION</i>	<i>TYPE OF SERVICE</i>
CUR OUT	CUR 100%
DEFINITION :	Allows the user to calibrate the 100% of the current output channel number. (Use a mA meter for this calibration)
HOW TO USE/EXECUTE IT :	The message "(output nb) CUR 100% " with a 0 flashing. You can change the current output value by pressing the ▲ ("+" flashing) ▼ ("- " flashing) keys. You accept the current output by pressing ENTER. You can leave the 0% current output service by pressing SETUP
NOTE :	When you press ENTER, the new 0% (4mA) current reference is stored in the recorder EEPROM memory. The recorder should be allowed to warm up for period of 1 hour before the current output calibration.

9.1 OVERVIEW

You have just received your application software package. This tool has been designed to modify, upload/download and store the recorder configuration.

The main functions of this software are :

- Reading the configuration of your recorder.
- Preparing or modifying the configuration from your PC.
- Downloading configuration from your PC to the recorder.
- Retrieving configuration stored on hard disk.
- Saving configuration on hard disk.
- Reading diagnostics.
- Upgrading software version.
- Creating special customer actuations.
- Monitoring data.

9.2 INSTALLATION

9.2.1 System Requirements

A PC AT Compatible personal computer with

- A Serial Communication card: RS232 as serial port 1
- A hard disk
- A color or B/W monitor
- A mouse optional
- Upto 625 KB RAM Free

9.2.2 New Installation

Insert the PC Loader CD into the CD drive. The setup is launched automatically. Run **Setup.exe** in case the setup does not launch automatically. If you don't have Administrator privilege, the setup will prompt to select Administrator user or enter the Administrator Password. Otherwise it will give "Kernel.error".(This is necessary to update the Registry Settings properly).

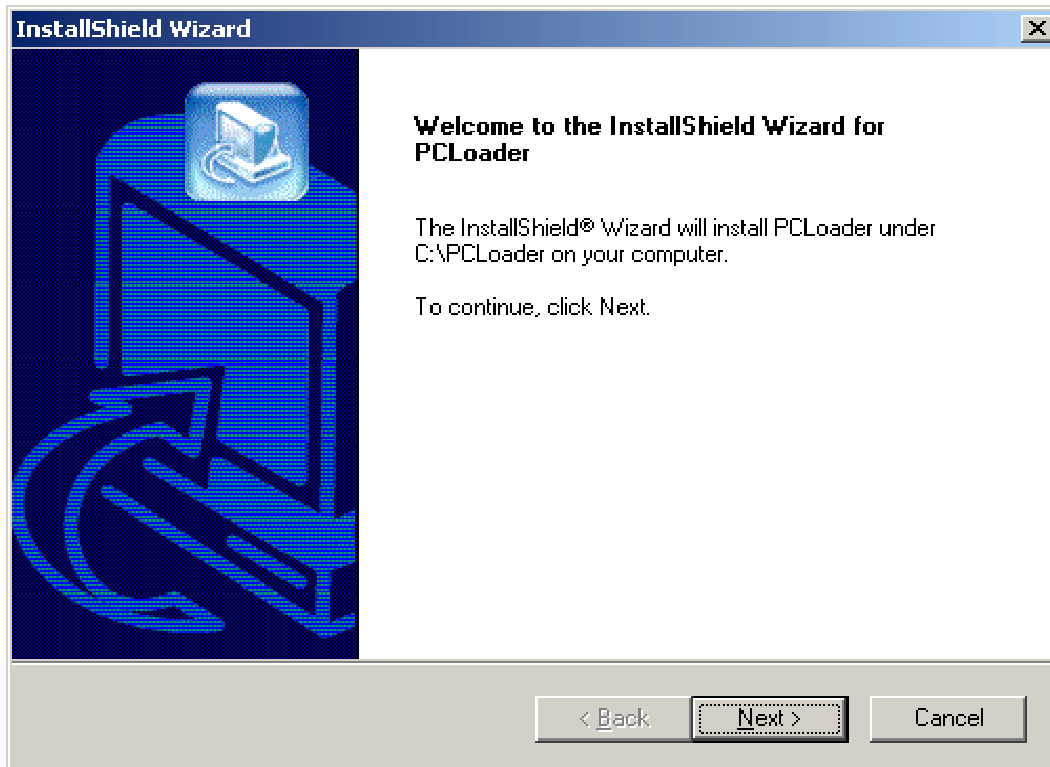

9. PC LOADER

Please ensure you have adequate disk space on **C:** and click **Next>** to proceed with the installation. Please note that PCLoader can only be installed in **C:** .

The progress of the installation is displayed.

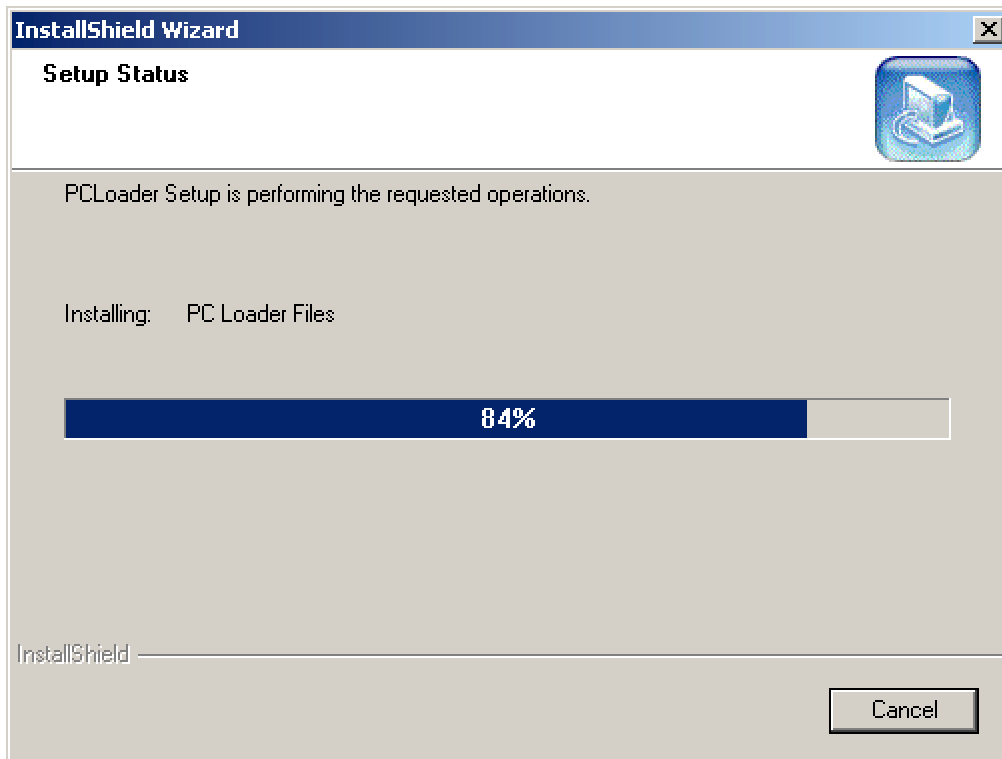

9. PC LOADER

Click **Finish** to complete the installation.

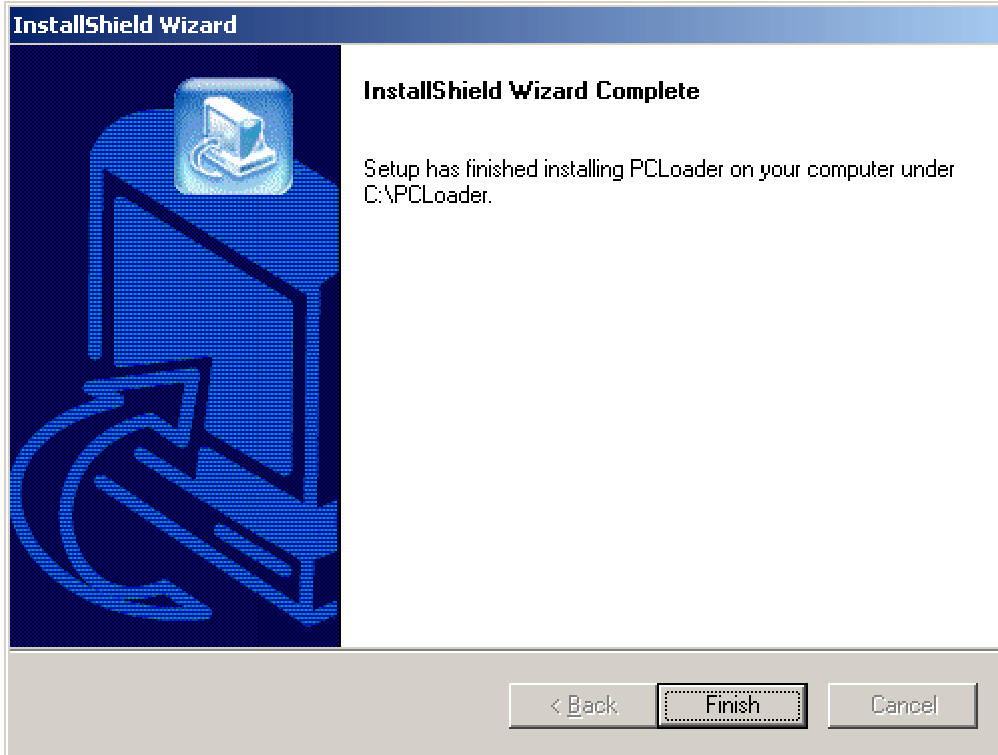

9.2.3 Upgrade old installation

Insert the PC Loader CD into the CD drive. The setup is launched automatically. Run **Setup.exe** in case the setup does not launch automatically. If you don't have Administrator privilege, the setup will prompt to select Administrator user or enter the Administrator Password. Otherwise it will give "Kernel.error".(This is necessary to update the Registry Settings properly).

If an older/similar version of PCLoader is already installed, the installation wizard will prompt you with the following options.

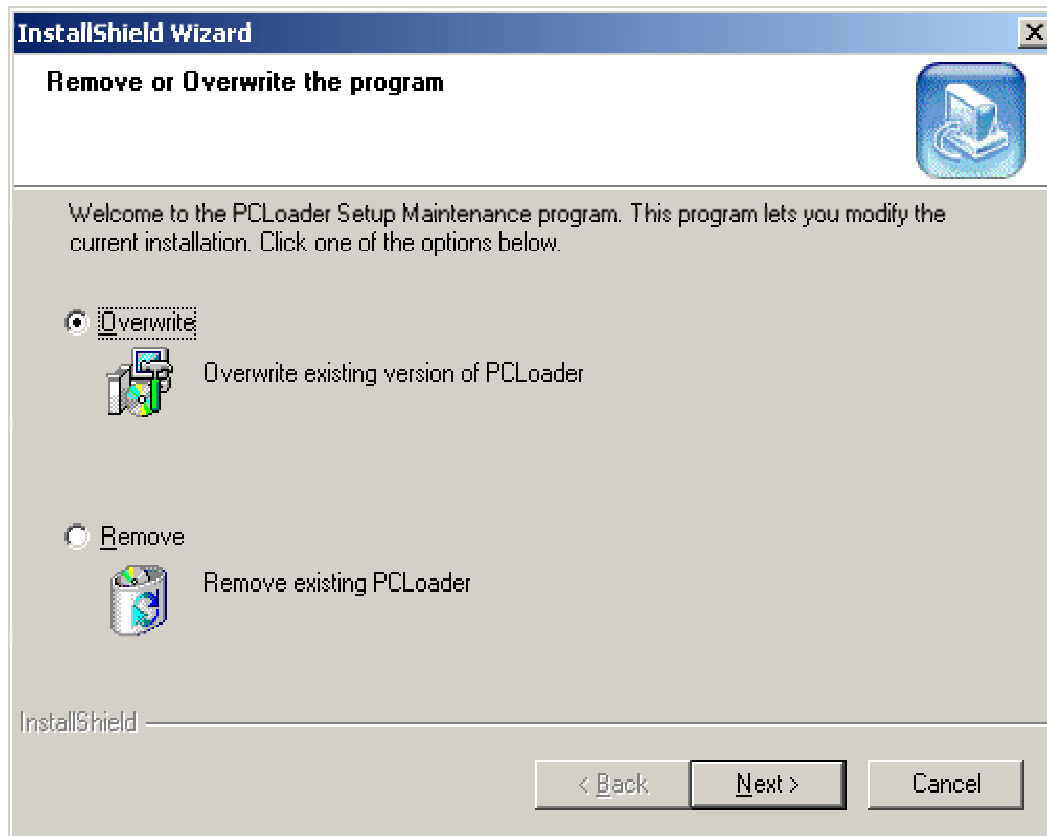

Select Overwrite to directly overwrite the older version and upgrade to the new version without running the set up twice.

Note: If any recorder configuration files are saved in the older PCLoader version you will be prompted

"Setup has found .cnf file. Do you want to retain them?"

Select **"Yes"** to retain the configuration files in their respective directories inside **C:\PCLoader** directory and to continue installation.

Select **"No"** to delete the configuration files along with the other files and to continue installation.

9.2.4 Uninstall

Select **Start > Settings > ControlParel\Add & Remove Programs**, then select **PCLoader**

or

Insert the PC Loader CD into the CD drive. The setup is launched automatically. Run **Setup.exe** in case the setup does not launch automatically.

Select Remove to uninstall the older version of PCLoader. You will be asked to confirm you want to delete the old files.

Note: If any recorder configuration files are saved in the older PCLoader version you will be prompted

“Setup has found .cnf file. Do you want to retain them?”

Select **“Yes”** to retain the configuration files in their respective directories inside **C:\PCLoader** directory and to delete non-configuration files.

Select **“No”** to delete the configuration files along with the other files.

To install the new version see New Installation.

If you don't have Administrator privilege, the setup will prompt to select Administrator user or enter the Administrator Password. Otherwise it will give **“Kernel.error”**.(This is necessary to update the Registry Settings properly).

9.3 USE

9.3.1 Startup

To launch PCLoader, double-click the **PCLoader** icon  on your Desktop or alternately, select **Start > Programs > PCLoader > DPR100**.

9.3.2 Menus

The software is based on the use of menu bars. To confirm a menu, you have three methods :

- Placing the cursor on the chosen menu, then press ENTER
- Pressing the highlighted key letter of the menu's name.
- Using the mouse.

9.3.3 Modifying fields of parameters

Some menus may allow the modification of parameter's values. There are two kinds of modifications according to the type of parameters.

Selective modification : When placing the index on the chosen parameter, you can modify it by pressing the ▲ or ▼ keys to scroll through allowed values. Most modifications are of this type.

- Modifying with the alphanumeric keyboard : in this case, position the cursor on the chosen parameter and type the required value.

9.3.4 Going from a parameter field to another one

- Press ► or ENTER to access to the next field.
- Press ◀ to access to the previous field.

Each time the cursor points to a field, a "help" message is displayed on the bottom line of the screen.

9.3.5 Leaving a menu

To leave a menu, you have two options :

- To leave the present menu and save your modifications, press F10 key.
- To leave the present menu without saving modifications, press ESC key.

9.4 SET UP COMM

In case you choose to use the communication option instead of the jack, you have to define the address of the recorder. (configured in the COMM sub-matrix)

Then you have to configure "NO CALL" in the AUTODIAL parameter of the recorder (COMM) and to configure "NEVER" in the FRQUNCY parameter (REPORT).

9.5 CONFIGURATION

9.5.1 Read and modify

Allows the user to read and modify a configuration.

9.5.2 User actuation

Allows the user to create his own specific sensor/range array, to load/save it, to download/upload it. Up to 2 user actuations can be downloaded into the same recorder.

9.5.2.1 Definition of a user actuation

Select "READ AND MODIFY USER ACTUATION", define the user actuation number and give a file name to save the user actuation.

9.5.2.2 Select the type of sensor

If T/C is chosen, you have to define the ambient temperature and the corresponding voltage at the rear of the recorder, for cold junction compensation.
Then define up to 51 point, less if you want.

Then press F9 to sort your points.

If it is OK, press F10 to save your definition.

9. PC LOADER

9.6 "SERVICE" PARAMETERS

A/D CONVERTER RESULTS

	DESCRIPTION	HOW TO MODIFY THE CURRENT VALUE
MEASURE	Process value	/
COLD JUNCTION OR THIRD WIRE VOLTAGE	Temperature of the cold junction or voltage of the third wire.	/
DATE OF CALIBRATION	Last date of cold junction calibration	/

COLD JUNCTION CALIBRATION

	DESCRIPTION	HOW TO MODIFY THE CURRENT VALUE
COLD JUNCTION TEMPERATURE	The displayed values are the current cold junction temperatures.	Type the desired value and then press ENTER Press F10 to process the calibration.

MATH BATCH

	DESCRIPTION	HOW TO MODIFY THE CURRENT VALUE
TIMER	Current math timer value, if a math package exists.	/
BATCH #	Current batch number.	/

9. PC LOADER

DIGITAL INPUT STATE

	DESCRIPTION	HOW TO MODIFY THE CURRENT VALUE
DIGITAL INPUT	State of digital inputs.	/

RELAY OUTPUTS STATE & RELAY OUTPUTS CONTROL

	DESCRIPTION	HOW TO MODIFY THE CURRENT VALUE
RELAYS COIL STATE	Current state of the relay coil.	/
RELAYS COIL CONTROL	Next state of the relay coil.	Press ▲ ▼ to modify the state. Press F10 to execute.

RECORDER SOFTWARE INFORMATION

	DESCRIPTION	HOW TO MODIFY THE CURRENT VALUE
RECORDER STATE	Current state of the recorder.	/
SOFTWARE VERSION	Software version of the recorder.	/

9. PC LOADER

EVENT STATE

	DESCRIPTION	HOW TO MODIFY THE CURRENT VALUE
CASSETTE OUT	ON if cassette is OUT of the recorder.	/
END OF PAPER	ON if paper length is equal to zero.	/
BATTERY	ON if battery voltage is too low.	/
ALARM	ON if one alarm at least is ON.	/
BURNOUT	ON if one channel at least is on burnout.	/
SHEDTIME	ON if shed time is elapsed.	/

RECORDER SPECIFICATION

	DESCRIPTION	HOW TO MODIFY THE CURRENT VALUE
RECORDER TYPE	Type of the recorder.	Select the desired type by pressing the ▲ or ▼ keys.
SOFTWARE VERSION	Software version of the recorder	/
HARDWARE VERSION	Hardware version of recorder.	/

MODIFY DATE & TIME ON RECORDER

	DESCRIPTION	HOW TO MODIFY THE CURRENT VALUE
DATE	Current date of the recorder	Type the desired value and then press ENTER
TIME	Current time of the recorder	

9.7 MONITORING

9.7.1 PARAMETERS INITIALIZATION

MAIN allows you to define :

- the sample period of the monitoring or archiving.
- a list of recorders you want to monitor/apply archiving and
 - for monitoring : SAMPLING RATE must be active
 - for archiving : SAMPLING RATE and ARCHIVING STATE must be active

ARCHIVING allows you to define the quantity and the size of the archived files.

9.7.2 REAL TIME DISPLAY

You are allowed to select the type of monitoring screen.

When using the ▲ or ▼ keys, you can change the recorder to monitor.

9.7.3 START/STOP ARCHIVING

To start or to stop archiving.

Archived files are stored in C:\PC LOADER\PC100CD\MONITOR directory.

The name of the ASCII files is "ASC XX - YY.EEE" where

- ASC stands for "ASCII"
- XX is the address of the recorder (01-99) or 00 when communication is made through JACK.
- YY is the file group number (00-09)
- EEE is the type of information contained in the file :

ANL stands for "analog input values and digital input status"

MAT stands for "mathematical function results"

AL1 stands for "alarm status and event status"

AL2 stands for "time of occurrence of alarms"

CFG stands for "configuration"

9.8 UPDATE SOFTWARE (FOR JACK ONLY)

Insert the CD that contains the "updated" recorder program in the drive.

To speed up the update, you can copy the entire CD on hard disk (where you want).

Then execute PCLOADER ("GO") and select the "UPDATE SOFTWARE" menu.

Follow the instructions displayed on the screen.

Be sure you have connected the recorder to the PC before any download of code.

The update takes around 10 minutes.

Never switch the Recorder or the computer off during a software download.

10. TROUBLESHOOTING

10.1 FAILURE SYMPTOMS AND TROUBLESHOOTING PROCEDURES

- ✓ Compare the symptoms with those listed below to identify the possible cause and take the corrective action.
- ✓ If the recorder is not restored to normal condition by the following check, please contact your nearest service office.
- ✓

	<h2>CAUTION</h2>
<p>OBSERVE ANTI STATIC PRECAUTIONS</p> <p>Full anti-static precautions MUST be observed when in contact with electronics of your recorder</p> <p>Ensure power disconnected before removing any boards from the recorder. Avoid touching components unless you are protected against electrostatic discharge as many boards have CMOS components which may be damaged.</p>	
<p>Failure to comply with these instructions may result in product damage</p>	

10.2 TROUBLESHOOTING LIST

Before any operation, for mechanical trouble execute an auto-test control. (For complete information see CK 114, kit instruction)

10.2.1 SELF-TEST MODE PEN RECORDER

- ✓ To access self-test mode, press the SETUP key when powering up.
 - ✓ The self-test involves the DIAGNOSTIC and the RUNNING IN.
 - ✓ s soon as the self-test begins, the DIAGNOSTIC starts and the RUNNING IN follows automatically.
- (See fig. 10-2)

1 DIAGNOSTIC :

- ✓ Duration : 5 mn approximately,
- ✓ To show the quality of mechanical adjustments and motor torque margins,
- ✓ To be significant, this operation has to be made in normal conditions :
200C +/-50 °C, 60 %RH +/-15 %, mounted horizontally with new pen cartridge(s).

2 RUNNING IN :

- ✓ Duration : 2 hours,
- ✓ Mechanical burn-in.

NOTE : - The cassette detection is made only at the beginning of the diagnostic.
The self-test is made with the recorder cassette with a 3 m minimum length of chart.

10.2.1.1 Diagnostic pen recorder

10.2.1.1.1 Control of the pen 1 adjustment

9 The figure 10-2 ref. 1 shows the check-test for the height pen 1 adjustment.
9 The scale extends from 1 to 9, a correct adjustment is between 4 and 9.

10. TROUBLESHOOTING

10.2.1.1.2 *Mechanical limits*

- ✓ The figure 10-2 ref. 2 shows the test of mechanical extremes. The vertical line(s) on the right must be over the 100 % chart. The vertical line(s) on the left must be under the 0 % chart.

10.2.1.1.3 *Printing of the mechanical 0 % and 100 %*

- ✓ The figure 10-2 ref. 3 shows the adjustment of the recorder. If the recorder is calibrated, the vertical lines must be written at the same place as the 0 % and the 100 % chart.

10.2.1.1.4 *Chart advance and print test*

- ✓ The figure 10-2 ref. 4 shows the test for chart advance with a diagram written every 20 mm.

10.2.1.1.5 *Printing of information message*

- ✓ The figure 10-2 ref. 5 shows the message.
- ✓ Time and date,
- ✓ Software version,
- ✓ Chart identification number

10.2.1.1.6 *Test for motor torque margins and mechanical slacks*

- ✓ The figure 10-2 ref. 6 is composed of 3 identical patterns for the pens 2 and 3 and the graph for pen 1 is discontinuous on the two first patterns.
- ✓ The first pattern for each channel is executed in subvoltage condition and the movements are accelerated.

10.2.1.1.7 *Adjustment check*

- ✓ For each channel, an adjustment check is executed at the end of the diagnostic. See figure 10-1 ref. 7.

10.2.1.2 *Running in pen recorder (See fig. 10-1)*

- ✓ For 2 hours
- ✓ Consumption : 3 m of chart paper
- ✓ The recorder prints a message every 65 mm, indicating the number of remaining cycles. (Total 36 cycles)
- ✓ For each cycle, the carriage adjustment check result is the following:
on the left channel one, on the middle channel two and on the right channel three.
For each channel: on the right the set value (22 or 23) and on the left the relative error (error values between -3 and +3 included are correct).
- ✓ At the end, the recorder executes a new DIAGNOSTIC, then indicates an end message with recapitulation of defective adjustment check.

10. TROUBLESHOOTING

10.2.1.3 APPENDIX

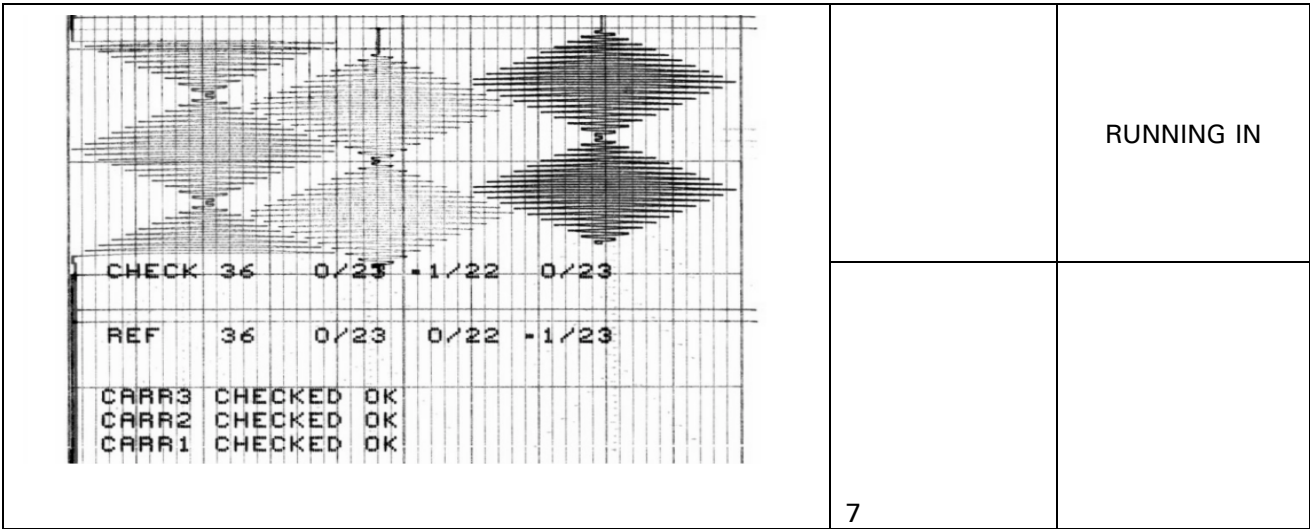

Figure 10-1

10. TROUBLESHOOTING

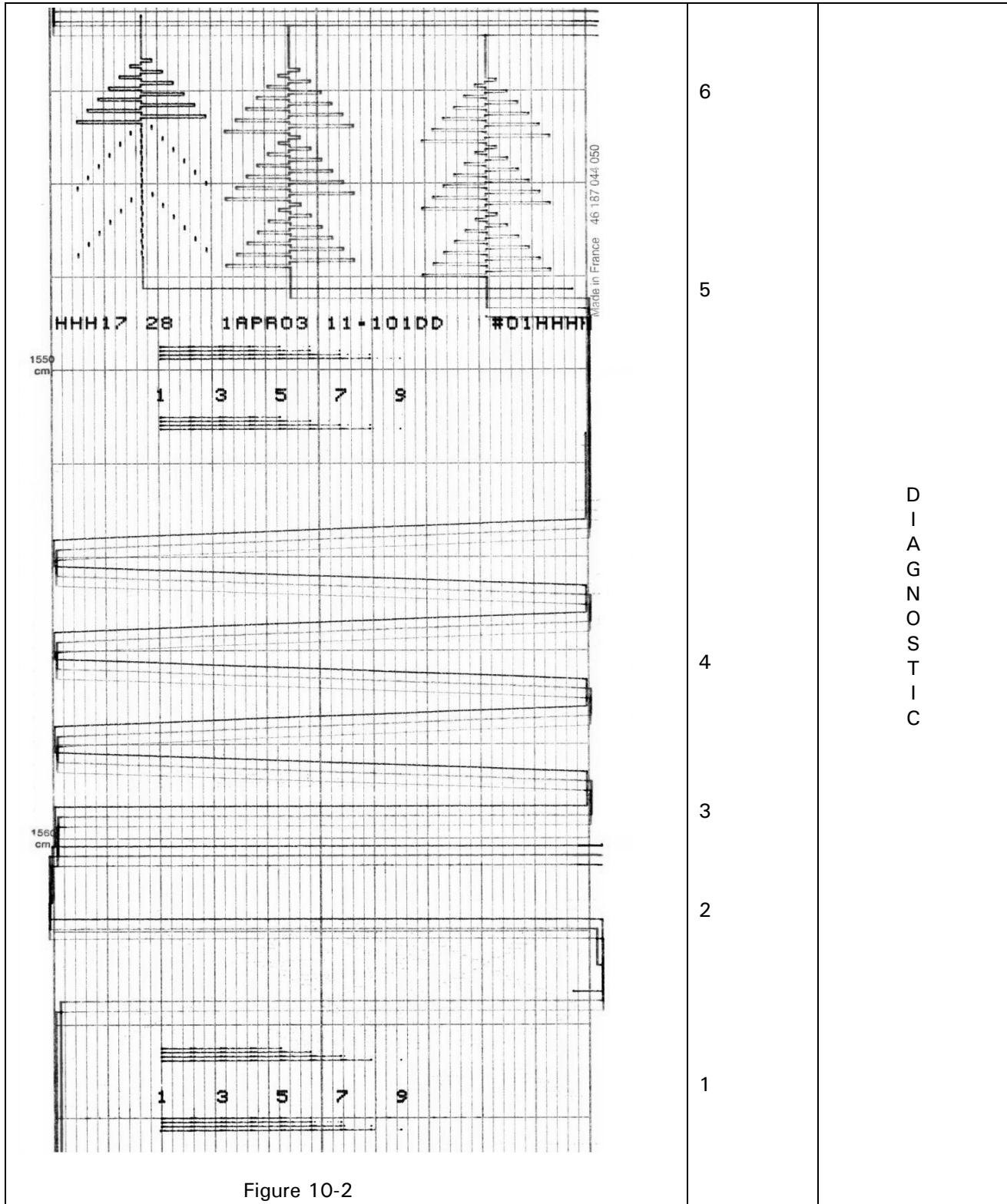

Figure 10-2

10.2.2 SELF-TEST MODE FOR MULTIPOINT RECORDER

- ✓ To access self-test mode, press the ENTER key when powering up.
- ✓ The self-test involves the DIAGNOSTIC and the RUNNING IN.
- ✓ As soon as the self-test begins, the DIAGNOSTIC starts and the RUNNING IN follows automatically. (See fig. 10-3)

1 DIAGNOSTIC :

- ✓ During 5 mn approximately,
- ✓ To show the quality of mechanical adjustments and motor torque margins,
- ✓ To be significant, this operation has to be made in normal conditions, 20 OC +/-50°C, 60 %RH +/-15 %, mounted horizontally with new print wheel.

2 RUNNING IN :

- ✓ During 2 hours,
- ✓ Mechanical burn-in.

NOTE : - The cassette detection is made only at the beginning of the diagnostic.
The self-test is made with the recorder cassette with a 1 m minimum length of chart.

10.2.2.1 Multipoint recorder diagnostic

10.2.2.1.1 Mechanical limits

- ✓ The figure 10-3 ref. 1 shows the test of mechanical extremes.
The vertical lines on the right must be over the 100 % chart.
The vertical lines on the left must be under the 0 % chart.

10.2.2.1.2 Printing of the mechanical 0 % and 100 %

- ✓ The figure 10-3 ref. 2 shows the adjustment of the recorder.
- ✓ If the recorder is calibrated, the vertical lines must be written at the same place as the 0 % and the 100 % chart.

10.2.2.1.3 Checking the color adjustment

- ✓ The figure 10-3 ref. 3 shows the check-test for the color adjustment.
- ✓ The scale extends from 0 to 8.
- ✓ Be careful with the writing of black and brown dashes. From a certain abscissa, the brown dash is higher than the black one.
- ✓ The adjustment is correct when the brown dash becomes higher, between 2 and 4 included.

10. TROUBLESHOOTING

10.2.2.1.4 *Printing of information message*

- ✓ The figure 10-3 ref. 4 shows the message.
- ✓ Time and date,
- ✓ Software version,
- ✓ Chart identification number.

10.2.2.1.5 *Checking the answer of the pen tip*

- ✓ The figure 10-3 ref. 5 shows the printing test.
- ✓ See 2 horizontal lines written in 6 colors.

10.2.2.1.6 *Test for motor torque margins and mechanical slacks*

- ✓ The figure 10-3 ref. 6 is composed of 3 serrated parts and each of them cut with a black line in the middle.
- ✓ The first serrated part and the beginning of the black line are executed with subvoltage, and movements are accelerated. (Coil included)

10.2.2.1.7 *Chart advance and print test*

- ✓ The figure 10-3 ref. 6 shows the test for chart advance with a diagram written every 20 mm.

10.2.2.1.8 *Adjustment check*

- ✓ An adjustment check for carriage and colors is executed at the end of the diagnostic.
- ✓ For the carriage: on the right the set value (22 or 23) and on the left the relative error (error values between - 3 and + 3 included are correct).
- ✓ For the color: on the right the set value (20 or 21) and on the left the relative error (error values between - 3 and + 3 included are correct).

10.2.2.2 *Running in multipoint recorder*

- ✓ For 2 hours
- ✓ Consumption : 1 m of chart paper
- ✓ The recorder prints a message every cycle, indicating the number of remaining cycles, (22 cycles at all),
- ✓ The 2 different graphs are the following (See figure 10-3 ref 7 and 8)
- ✓ For each cycle, the adjustment is controlled for carriage and colors.
- ✓ The adjustment check result is the following: on the left the carriage control and on the right the color control.
- ✓ At the end, the recorder executes a new DIAGNOSTIC, then indicates an end message with recapitulation of defective adjustment check .

10. TROUBLESHOOTING

10.2.2.3 APPENDIX

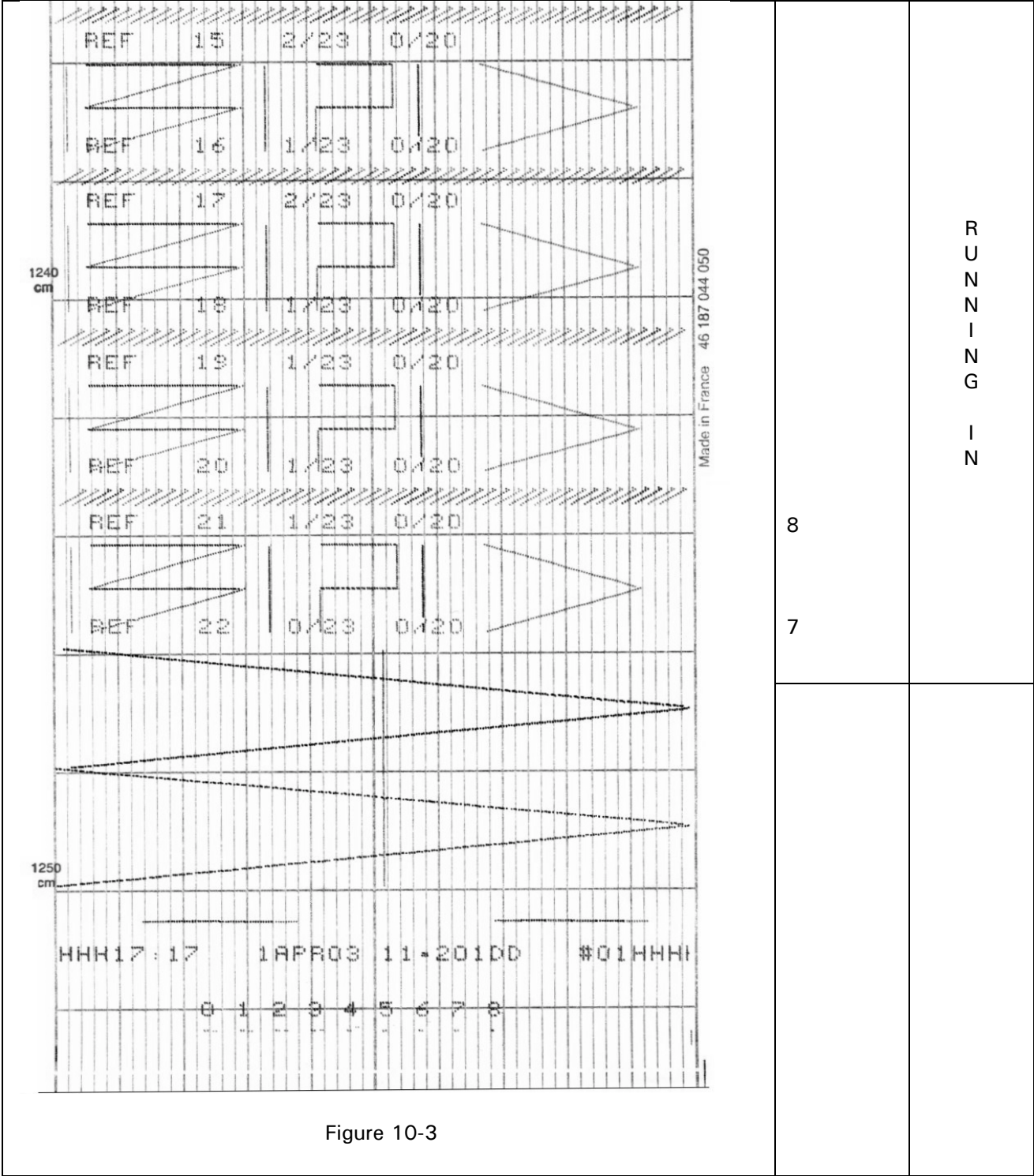

Figure 10-3

10. TROUBLESHOOTING

10.2.3 SYMPTOM : The recorder is inoperative

POSSIBLE CAUSE	CORRECTIVE ACTION
No message is displayed or in case of analog input basic actions, "NO INPUT" is displayed for the considered input.	Check "sensor", "actuation" configuration and switch position on the input card.
Loss of line power	Use an AC voltmeter to check whether power is being applied to the supply terminals L1 and L2/N.
Blown line fuse	Replace line fuse. Ensure that fuse is correct for supply voltage.
The fuse connection is not correct.	Clean the fuse connection.
Power supply module	Check voltage on power supply. (Refer to CK 113) If voltage is not correct, replace power supply module.

10.2.4 SYMPTOM : The display is inoperative

POSSIBLE CAUSE	CORRECTIVE ACTION
Power supply module	If chart illumination failed, replace power supply module.
Wrong connection	Check the flat cable connections on display and mother board (refer to CK 152).
Display module	Replace display module (refer to CK 153).
Mother board	Replace mother board (refer to CK 152).

10. TROUBLESHOOTING

10.2.5 SYMPTOM : The chart is inoperative

POSSIBLE CAUSE	CORRECTIVE ACTION
No message is displayed or in case of analog input basic actions, "NO INPUT" is displayed for the considered input.	Check "sensor", "actuation" configuration and switch position on your input card.
Print inhibit is activated by digital input.	Check the "print action" configuration in the digital input matrix and status of digital inputs.
Chart is incorrectly installed.	Install chart correctly. (See figures on pages 2-8 and 2-9)
Chart is torn.	Advance chart beyond torn sections.
Chart drive gear train is damaged.	Replace chart cassette assembly.
Power supply	Check voltage on power supply. (Refer to CK 113). If voltage is not correct, replace power supply module.
Chart drive logic	If no other action is fixed, replace mother board. (Refer to CK 152)
"END PAPER" message	When you see "END PAPER" message on the display ("end of paper" message), the recorder informs you that the chart arrives at the end. To remove this message, press until you read "PAPLG = ..." (chart length) and press ENTER . After that, the "END PAPER" message disappears.

10.2.6 SYMPTOM : The print carriage is inoperative

POSSIBLE CAUSE	CORRECTIVE ACTION
Carriage drive cable tension is incorrect.	Check and adjust drive cable tension. (Refer to CK 126)
Bad connection	Check wiring connections. (Refer to pages 2-5 to 2-7)
Carriage drive cable is broken.	Replace carriage drive cable. (Refer to CK 126)
Carriage drive motor	Make an auto-test. (Refer to CK 114) Refer carriage drive motor. (Refer to CK 119)
Carriage drive motor logic	Replace mother board. (Refer to CK 152)
Power supply	Check voltage on power supply. (Refer to CK 113). If voltage is not correct, replace power supply module.

10. TROUBLESHOOTING

10.2.7 SYMPTOM : The print head is inoperative

POSSIBLE CAUSE	CORRECTIVE ACTION
Pen recorder	
Pen cartridge missing	Fit pen cartridge. (Refer to pages 2-11 to 2-13)
Pen cartridge wrongly fitted	Install cartridge correctly and push fully home.
Trace instead of alphanumeric printing	Check wiring connections, replace motor 2 and finally replace carriage.
One pen does not move	<ul style="list-style-type: none">- Check wiring.- Check carriage drive cable.- Replace the motor corresponding to that pen.- Replace mother board.
Multipoint recorder	
Ink barrel missing	Fit ink barrel (Refer to pages 2-14 and 2-15)
Ink barrel drive motor	According to the auto-test result (Refer to CK 114), replace ink drive motor. (Refer to page 1-9)
Print head logic	Replace mother board (Refer to CK 152)
Ink barrel drive motor logic	Replace mother board (Refer to CK 152)

10.2.8 SYMPTOM : Printing incorrect color (only for the multipoint recorder)

POSSIBLE CAUSE	CORRECTIVE ACTION
Ink barrel is incorrectly installed.	Check ink barrel installation. (Refer to pages 2-14 and 2-15)
Wiring is disconnected.	Check wiring connections (Refer to pages 2-5 to 2-7)
Color change motor	According to the auto-test result. (Refer to CK 114) Replace color change motor (Refer to CK 119)
Power supply	Check voltage on power supply. (Refer to CK 113). If voltage is not correct, replace power supply module.
Color change motor logic	Replace mother board (Refer to CK 152)

10. TROUBLESHOOTING

10.2.9 SYMPTOM : Wrong date/time

POSSIBLE CAUSE	CORRECTIVE ACTION
Date and time are lost	Replace battery and contact your local office. Refer to CK 152.

10.2.10 SYMPTOM : The alarm relay is inoperative or does not have the desired effect

POSSIBLE CAUSE	CORRECTIVE ACTION
Configuration is incorrect.	Check the jumper selection on relay board Check the "relay" parameter in the alarm matrix.
The connectors are incorrectly fitted.	Connect and refit. (Refer to pages 2-5 to 2-7)
Alarm relay board	Replace the board (Refer to CK 110)

10.2.11 SYMPTOM : Analog input records outside specified accuracy tolerance

POSSIBLE CAUSE	CORRECTIVE ACTION
Recorder configured for wrong sensor or actuation.	Check "sensor" and "actuation" configuration.
"Range" not correct.	Check "range" configuration.
Recorder not configured for the correct supply frequency.	Check "frequency" (50/60 Hz) configuration.
The analog card is not correctly fitted.	Reconnect it.
Open circuit	Check sensor, leads and input terminals.
Bad contact or bad setting on the switches of input board	Check the switch position. Push the switches completely on the high or low position.
Environmental conditions outside rated limits.	Ensure that ambient temperature and relative humidity are within limits given in the product specification sheet.
Analog input card	Replace analog input card. (Refer to CK 110)

10. TROUBLESHOOTING

10.2.12 SYMPTOM : Too much space between points (Multipoint recorder only)

POSSIBLE CAUSE	CORRECTIVE ACTION
Check the chart speed It could be too high for the application.	Reconfigure chart speed.

10.2.13 SYMPTOM : No communication with PC loader

POSSIBLE CAUSE	CORRECTIVE ACTION
User error	See section 9.
Ground wiring not connected.	It is mandatory to connect the ground wiring.
If you choose pen recorder instead of multipoint recorder, you have a communication error.	Select correct type of recorder.
Interface is not operative.	Replace mother board. (Refer to CK 152)
No response from device.	Check wiring (connection, ...) of switched PC loader. Replace PC loader box.
Incompatble version of PC Windows Operating System	Use compatible version of Windows Operating System.

10.2.14 SYMPTOM : The printed traces are unstable

POSSIBLE CAUSE	CORRECTIVE ACTION
The chart paper is not in accordance with our specifications.	Fit correct chart.
Verify the 0 % and the 100 % printer calibration.	Reconfigure.
The printer motor is loosing steps.	Clean the bar on which the printing carriage moves with a dry piece of cloth.

10. TROUBLESHOOTING

10.2.15 SYMPTOM : The chart illumination failed

POSSIBLE CAUSE	CORRECTIVE ACTION
Wiring disconnected	Check wiring connections. (Refer to pages 2-5 to 2-7)
Fluorescent tube connectors are not properly seated.	Check fluorescent tube connectors. (Refer to CK 111)
Fluorescent tube	Replace fluorescent tube. (Refer to CK 111)
Power supply	Check voltage on power supply. (Refer to CK 113)
If voltage is not correct,	replace power supply module.

10.2.16 SYMPTOM : The current output failed

POSSIBLE CAUSE	CORRECTIVE ACTION
Configuration is incorrect.	Check the current "CH #", "LOW VAL" and "HIGH VAL" parameters in the current output matrix.
The connectors are incorrectly fitted.	Connect and refit. (Refer to pages 2-5 to 2-7)
Current output board	Replace the board.
Current output failed	Check the switch "SW1" of the current output board: On position "ON" the wiring matches with internal power supply. On position "OFF" the wiring matches with external power supply. See paragraph 2.5 TERMINAL CONNECTIONS

10. TROUBLESHOOTING

10.3 Error messages

MESSAGE	DESCRIPTION
CASSETTE OUT	The Chart Cassette has been removed
END PAPER	The Chart Length Counter has reached 0
BATTERY FAIL	The Lithium Battery for the Real Time Clock is at the level less than 3V.
ONE ALARM ON	The configured Alarm/Event has occurred
BURNOUT	The input is configured and in a Burnout condition; or an Input in Burnout has been disabled
SHED TIME	The configured time period within which the communications response has not occurred
PRT INHIBIT	All print actions have been inhibited
EV PRECURSOR	Event Precursor mode is enabled and the recorder is in standby.
TEST PASSED	The recorder passes the self-test (either diagnostic or running-in test)
TEST FAILED	The recorder fails the self-test (either diagnostic or running-in test)
NO RESPONSE	There is no communication between the recorder and the PCloder.

11. KITS LIST

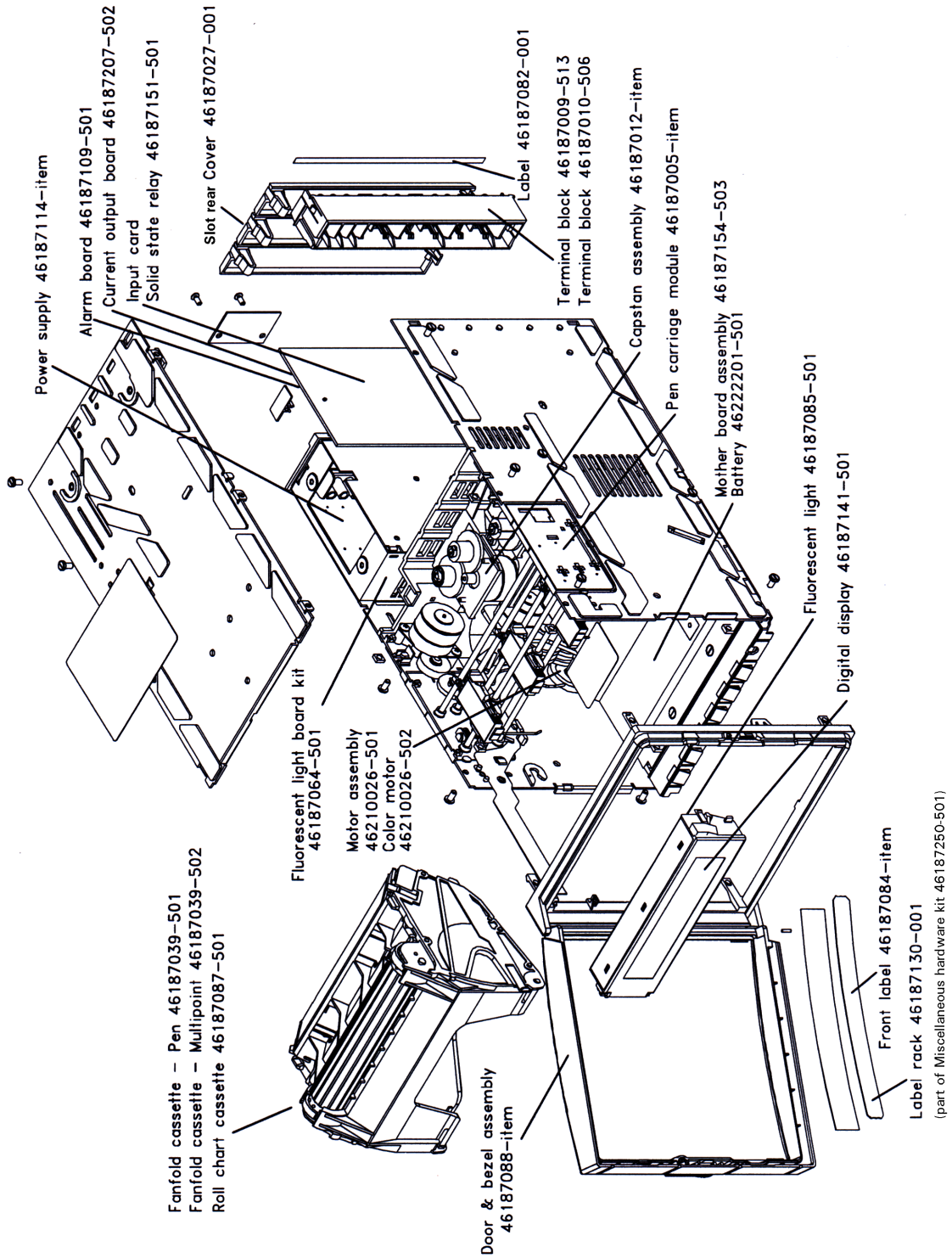

11. KITS LIST

11.1 ELECTRONIC PARTS

KITSLIST	PART #	CK #
ELECTRONIC		
-Universal input card (3 Analog + 2 digital inputs) Opto MOS relay - 2 logic input boards only - Alarm board (6 relays) - Alarm board (2 relays) - Current output board (2 outputs) Note : These kits do not include the rear terminal block.	46187151-501 46187151-502 46187109-501 46187109-502 46187207-502	110
Kit to add or replace fluorescent light module	46187064-501	111
Mother board ass'y	46187154-503	152
Universal power supply with 24 VDC output : - 85 to 264 V (Europe) - 24 VAC/DC (Europe/U.S.) - 48 VAC/DC (Europe/U.S.) - 85 to 264 V (U.S.) CSA -	46187114-501 46187114-502 46187114-503 46187114-504	113
Universal power supply without 24 VDC output : - 85 to 264 V (Europe)	46187114-511	
Digital display Display Cable	46187141-501 46187142-501	153
Communication output board	46187197-501	Communication Option Manual

11. KITS LIST

11.2 MECHANICAL PARTS

KITSLIST	PART #	CK #
MECHANICAL PARTS		
Kit bezel with door ass'y (Latch) Kit bezel with door ass'y (Key lock)	46187088-501 46187088-502	115
Print module : - 1 pen - 2 pen - 3 pen - Multipoint	46187005-511 46187005-521 46187005-531 46187005-561	117
Capstan assembly with motor - Pen Capstan assembly with motor - Multipoint Drive cable - Pen Drive cable - Multipoint	46187012-501 46187012-502 46187156-501 46187156-506	118/126
Motor assembly (except color and carriage multipoint) Motor assembly (color and carriage multipoint only)	46210026-501 46210026-502	119
Portable case	46187074-501	154
Rear cover	46187099-501	155
Chart cassette - Roll Chart cassette - Fanfold - Pen Chart cassette - Fanfold - Multipoint (smooth roller)	46187087-501 46187039-501 46187039-502	
Reroll tube assembly	46180048-501	
Color opto gear kit - Multipoint	46187041-501	218
Side plate kit	51452685-501	

11. KITS LIST

11.3 MISCELLANEOUS PARTS

K I T S L I S T	P A R T #	C K #
MISCELLANEOUS		
Fluorescent tube replacement	46187085-501	124
Input terminal block Alarm terminal block, Current output block	46187009-513 46187010-506	110
Slot rear cover	46187027-100	
Battery	46222201-501	152
PC Loader - Interface + Disk + Cables New PC software diskette only	46187121-001 46187122-501	132
Kit Math package #1 Kit Math package #2 Kit Math package #3 Kit Math package #4	46187201-501 46187201-502 46187201-503 46187201-504	Math Option Manual
Fuse : - Line voltage 1 Amp (Europe) - Line voltage 1 Amp (USA) - 24/48 V AC/DC 3.2 Amp (Europe) - 24/48 V AC/DC 3.2 Amp (USA)	46182886-504 46182886-503 46182886-502 46182886-501	
Panel mounting kit	46187086-502	
Process label : - Pen 1-2-3 - Multipoint 6 pts	46187084-503 46187084-506	
Resistor kit for mA input (250 ohms)	46181080-504	
Cable between PC interface and PC	46210040-501	
Cable Jack between PC interface and Recorder	46225600-001	
Communication Cable between PC and Recorder	46210061-001	
Miscellaneous Hardware kit – includes fuse (US & European), fuse caps, display lens, ground back shield, display metal bracket, hinge pin, slot cover, label holder, Pen & Multi-point label	46187250-501	

11. KITS LIST

11.4 CONSUMABLES

Use this page (or copy) to order your consumables.

Description/Part.	Reference	Quantities	Minimum Order Qty
Pen 1 Blue (See note)	46187001-001		5
Pen 2 Red	46187001-002		5
Pen 3 Green	46187001-003		5
Ink cartridge Multipoint (6 colours)	46180501-001		2
Chart Roll			
40 divisions	46187044-040		25
50 divisions	46187044-050		5
60 divisions	46187044-060		25
65 divisions	46187044-065		25
70 divisions	46187044-070		25
75 divisions	46187044-075		25
100 divisions	46187044-100		25
Special	on request		100
Fanfold			
40 divisions	46187045-040		25
50 divisions	46187045-050		5
60 divisions	46187045-060		25
65 divisions	46187045-065		25
70 divisions	46187045-070		25
75 divisions	46187045-075		25
100 divisions	46187045-100		25
Special	on request		100
- Universal Power Supply 85 to 264 Vac	46182886-504 (Europe: 5×20) 46182886-503 (US: 6.3×32)		10 10
Fuse			
- Power Supply 24 Vac/dc or 48 Vac/dc	46182886-502 (Europe: 5×20) 46182886-501 (US: 6.3×32)		10 10
Front label			
1-2-3 channels	46187084-003		
6 channels	46187084-006		5
Note: As pen 1 prints all messages, it will require replacement before pens 2 or 3. It is recommended to order 3 times the quality of pen 1.			

For the best product performance Honeywell recommends the use of Honeywell charts and pens, use of other manufacture's charts and pens may degrade product performance.

11. PARTS LIST

12. PROMPTS TRANSLATIONS

12.1 MATRICES

EN	FR	GE	IT	SP	SW
----	----	----	----	----	----

R /W	L /E	L /S	L /S	L /E	L /S
PRN	IMP	DRU	STP	IMP	SKR
SRV	SRV	SRV	SRV	SRV	SER

ANALOG	ANALOG	ANALOG	ANALOG	ANALOG	ANALOG
ALARM AN	ALARME	ALARM AN	ALL AN	ALARM AN	LARM AN
DIGITAL	DIGITAL	BIN	DIGITALE	DIGITAL	DIGITAL
MESSAGES	MESSAGES	TEXT	MESSAGGI	MENSAJES	MEDDELA
CHART	ECH DIAG	DIAG	CARTA	GRAFICO	PAPPER
MISCEL	DIVERS	PAR	MISTO	VARIOS	ANDRA
BATCH	LOT no	CHRG	INCR DAT	LOTE	SATS
PRINTER	IMPRIMTE	DRUCKER	STAMPANT	IMPRESR	SKRIVARE
EVENT	EVENEMNT	MELD	EVENTI	SUCESO	HÄNDELSE
MMI	AFF/CLAV	MMI	TASTIERA	MMI	MMI
CUR OUT	SORTIEmA	STRÖMAUS	USCITAmA	SALIDAmA	STRÖM UT

12.PROMPTS TRANSLATIONS

ANALOG MATRIX

EN	FR	GE	IT	SP	SW
SENSOR	CAPTEUR	GEBER	SENSORE	SENSOR	GIVARE
RANGE	GAMME	BEREICH	CAMPO	RANGO	OMRÅDE
T/C COMP	COMP T/C	T/C KOMP	COMP T/C	COMP T/C	T/C KOMP
FILTER	FILTRE	FILTER	FILTRO	FILTRO	FILTER
LOW VAL	VAL BAS	UB WERT	VAL BASS	VAL INF	LÄGRE GR
HIGH VAL	VAL HAUT	OB WERT	VAL ALTO	VAL SUP	ÖVRE GR
BURN OUT	RPT CAPT	F BRUCH	SICUREZ	ROTURA	AVBRÅTT
STD MATH	OPT MATH	STD MATH	OP MAT	OPC MATM	TILLV.MA
CH #	VOIE no	KANALNR	CANALE	CANAL	KANAL NR
ZERO ADJ	ADJ ZERO	NULLJUST	REG ZERO	AJS CERO	NOLLJUST

12.PROMPTS TRANSLATIONS

ALARM AN MATRIX

EN	FR	GE	IT	SP	SW
SP VALUE	CONSIGNE	GRENZWRT	VAL SP	VALOR PC	BÖRVÄRDE
HYSTERES	HYSTERES	HYSTERES	ISTERESI	HISTERS	HYSTERES
OCCURNCE	OCCURNCE	AUFTRITT	STATO	OCURRCIA	NR. LARM
CHANNEL	VOIE	KANAL	CANALE	CANAL	KANAL
AL TYPE	TYPE AL	ALARMTYP	TIPO ALL	TIPO ALM	LARMTYP
CH DIFF	VOIE DIF	KA DIFF	CAN DIF	DIF CNL	KAN DIFF
RELAY#	RELA no	RELAISNR	N RELE	RELE #	RELÄ NR.
ACTION	ACTION	FUNKTION	AZIONE	ACCION	ÅTGÄRD
MESSAG #	MSG no	TEXT NR	N MESSAG	MENSAJ #	MED. NR.
MSG COL	COUL MSG	TEXTFARB	COL MSG	COL MSG	MED. FÄRG
PRNT MSG	TYPE MSG	TEXT DRU	TIPO MSG	TIPO MSJ	MED. TYP
AL = RED	AL = ROUGE	AL = ROT	ALL = ROSS	ALL = ROJO	LA = RÖD

12.PROMPTS TRANSLATIONS

DIGITAL MATRIX

EN	FR	GE	IT	SP	SW
TYPE	TYPE	TYPE	TIPO	TIPO	TYP
CH DIFF	VOIE DIF	KA DIFF	CAN DIF	DIF CNL	KAN.DIFF
ACTION	ACTION	FUNKTION	AZIONE	ACCION	ÅTGÄRD
RELAY #	RELAJ no	RELAISNR	N RELE	RELE	RELÄ NR
MESSAG #	MSG no	TEXT NR	N MESSAG	MENSAJE	MED. NR
MSG COL	COUL MSG	TEXTFARB	COL MSG	COL MSJ	MED.FÄRG
PRNT MSG	TYPE MSG	TEXT DRU	TIPO MSG	TIPO MSJ	MED. TYP
TRACE	TRACE	SPUR	TRACCIA	TRAZO	SPÅR
TR COLOR	COUL TRA	SPURFARB	COL TRAC	COLOR TR	SPÅRFÄRG
RED TRAC	AL= ROUGE	AUFZ ROT	TR ROSSA	TRA ROJO	RÖTTSPÅR
POSITION	POSITION	POSITION	POSIZION	POSICION	PLATS

MESSAGES MATRIX

EN	FR	GE	IT	SP	SW
MESSAGE	MESSAGE	TEXT	MESSAGGI	MENSAJE	MEDDELA

12.PROMPTS TRANSLATIONS

CHART MATRIX

EN	FR	GE	IT	SP	SW
TAG NAME	NOM	KA BEZ	TARGHET	NOM IDEN	TAGNAMN
ENG UNIT	UNITE	EINHEIT	UNIT ING	UNID ING	ING ENHE
DECIMAL	DECIMAL	DEZIMAL	DECIMALE	DECIMAL	DECIMAL
MIN RG1	GAM1 MIN	MIN BER1	MIN C1	MIN RG1	OMR1.MIN
MAX RG1	GAM1 MAX	MAX BER1	MAX C1	MAX RG1	OMR1.MAX
RG1 COL	COUL G1	FARBBER1	COLOR C1	COL RG1	OMR1FÄRG
MIN RG2	GAM2 MIN	MIN BER2	MIN C2	MIN RG2	OMR2.MIN
MAX RG2	GAM2 MAX	MAX BER2	MAX C2	MAX RG2	OMR2.MAX
RG2 COL	COUL G2	FARBBER2	COLOR C2	COL RG2	OMR2FÄRG
ZONING	ZONE	ZONE	ZONA	ZONA	ZON
TRACE	TRACE	SPUR	TRACCIA	TRAZO	SPÅR
RG USED	GAM UTIL	VERW BER	C USATO	RG USADO	OMR ANV

12.PROMPTS TRANSLATIONS

MISCEL MATRIX

EN	FR	GE	IT	SP	SW
TIME	HEURE	ZEIT	ORA	HORA	TID
DATE	DATE	DATUM	DATA	FECHA	DATUM
LANGUAGE	LANGUE	SPRACHE	LINGUA	IDIOMA	SPRÅK
IDNTIF #	no PAP	DIAGR NR	N IDENT	IDNTIF no	IDENT.NR
FREQUNCY	FREQUNCE	FREQUENZ	FREQUENZ	FRECNCIA	FREKVENS
PSSWRD 1	CODE no1	PASSW 1	CODICE 1	CLAVE 1	KODORD 1
PSSWRD 2	CODE no2	PASSW 2	CODICE 2	CLAVE 2	KODORD 2
MATH PAK	OPT.MATH	MATH FKT	FUNZ MAT	PAQ MATM	MATEMATI
USE CONF	CONF UTI	KONF BEN	CONF US	USO CONF	ANV KONF

BATCH MATRIX

EN	FR	GE	IT	SP	SW
START	DEMARRAG	START	PARTENZA	EMPEZAR	ÅTERST.
RESET	RAZ	RUECKSET	RESET	REINCIAR	RESET
BATCH #	no DEBUT	CHARGENR	N DATI	LOTE #	SATS NR.
BACKUP	SAUVER	SICHERN	ARCHIVIO	SALVAR	SPARA
LINE 1	LIGNE 1	ZEILE 1	RIGA 1	LINEA 1	LINJE 1
LINE 2	LIGNE 2	ZEILE 2	RIGA 2	LINEA 2	LINJE 2
LINE 3	LIGNE 3	ZEILE 3	RIGA 3	LINEA 3	LINJE 3
LINE 4	LIGNE 4	ZEILE 4	RIGA 4	LINEA 4	LINJE 4

12.PROMPTS TRANSLATIONS

PRINTER MATRIX

EN	FR	GE	IT	SP	SW
CHART LG	LONG.PAP	PAPIERLG	CARTA	LGDGRAF	PAPP.L[N
SPD UNIT	UNITE	VOR EINH	VELOCITA	UNID VEL	HAST.ENH
SPEED 1	VITESSE1	GESCH 1	VELOC1	VELCD1	HAST.1
SPEED 2	VITESSE2	GESCH 2	VELOC2	VELCD2	HAST.2
SPD USED	VIT.UTIL	GEWAEHLT	VEL USAT	VEL USAD	HAST ANV
TABULAR 1	TABUL. 1	TABELLE1	TABULAT1	TABULAR1	TABELL 1
TABULAR 2	TABUL. 2	TABELLE2	TABULAT2	TABULAR2	TABELL 2
REC MODE	TYPE ENR	BETR ART	TIPO REG	MODO REG	REQ.MOD
PRT MODE	TYPE IMP	AUSDRUCK	TIPO STP	MODO IMP	UTSK.MOD
PRT INTV	INTV IMP	INTERVAL	INTV STP	INTR IMP	UTSKINTV
PRT PV	IMPR VP	DRU PV	VAL STP	IMP VAL	UTSK VAR
PRT RANG	ECHELLES	DRU BER	CAMPO ST	IMP RANG	UTS KOMR
PRT TIME	HEURE?	DRU ZEIT	TEMPO ST	IMP HORA	UTSK TID
PRT TAG	IMP NOM	DRU TAG	TARG STP	IMP IDEN	UTSK TAG
PEN OFFS	RAT. PLUM	ZEITVERS	REG PEN	DESP PLM	SKR OFFS

EVENT MATRIX

EN	FR	GE	IT	SP	SW
TYPE	TYPE	TYPE	TIPO	TIPO	TYP
RELAY #	RELAJ no	RELAISNR	N RELE	RELE no	RELÄ NR.
DISPLAY	AFFICHER	ANZEIGE	INDICAT	VISUALZ	DISPLAY

12.PROMPTS TRANSLATIONS

MMI MATRIX

EN	FR	GE	IT	SP	SW
KEY DOWN	FLECHE B	TASTE UN	TAST GIU	TECL INF	KNAPP NE
KEY UP	FLECHE H	TASTE OB	TAST SU	TECL SUP	KNAPP UP
KEY LEFT	FLECHE G	TASTE LI	TAST SX	TECL IZQ	KNAPP VÄ
KEY RIGH	FLECHE D	TASTE RE	TAST DX	TECL DCH	KNAPP HÖ
DISPLAY	AFFICHER	ANZEIGE	INDICAT	VISUALZ	DISPLAY
BRIGHT	LUMIERE	HELLIGK	LUMINOS	BRILLO	LYSINTN.

CURRENT OUTPUT MATRIX

EN	FR	GE	IT	SP	SW
CH #	VOIE	KANAL	CANALE	CANAL	KANAL
LOW VAL	VAL BAS	UB WERT	VAL BASS	VAL INF	LÄGRE GR
HIGH VAL	VAL HAUT	OB WERT	VAL ALTO	VAL SUP	ÖVRE GR

12.PROMPTS TRANSLATIONS

12.2 SERVICE

ANALOG INPUT SERVICE

EN	FR	GE	IT	SP	SW
PV CALIB	CAL VOIE	EING KAL	CALIB PV	CALIB VP	KALI ÄRV
JUNCT To	To JONCT	TEMPVGST	T GIUNTO	UNION To	C/J TEMP
CAL DATE	CAL DATE	KALDATUM	CAL DATA	FECH CAL	KAL.DAT.
JUNCT oC	JONCT oC	oC VGLST	oC GIUNT	UNION oC	C/J oC

MATH SERVICE

EN	FR	GE	IT	SP	SW
TIMER	TEMPORIS	ZEITGEB	. TIMER	TEMPORZR	TIMMARE

DIGITAL SERVICE

EN	FR	GE	IT	SP	SW
STATUS	ETAT	STATUS	STATI	ESTADO	STATUS

BATCH SERVICE

EN	FR	GE	IT	SP	SW
BATCH #	LOT no	NOTIZ Nr	N DATI	LOTE no	SATS NR.

12.PROMPTS TRANSLATIONS

PRINTER SERVICE

EN	FR	GE	IT	SP	SW
CHART LG	LONG.PAP	PAPIERLG	CARTA	LGD GRAF	PAPP.LÄN
0% CHART	0% PAP	0% DIAG	0% CARTA	GRAF 0%	0% PAPP
100% CHT	100% PAP	100%DIAG	100%CART	GRAF100%	100%PAPP
CHARACTR	SYMBOLES	ZEICHEN	CARATTER	CARACTRZ	KARAKT.

MISCEL SERVICE

EN	FR	GE	IT	SP	SW
SERIAL #	no SERIE	AUTRG NR	N ORDINE	ORDEN no	SERIE NR
FNL TEST	TEST FNL	END TEST	TEST FIN	PRBA FNL	SLUTTEST
HARDWARE	HARDWARE	HARDWARE	HARDWARE	HARWARE	HÅRDVARA
SOFTWARE	LOGICIEL	SOFTWARE	SOFTWARE	SOFTWARE	MJUKVARA
BACKUP	SAUVE	SICHERN	ARCHIVIO	SALVAR	BAT.KVAR
RESTORE	RESTIT.	LADEN	RESTORE	RESTORE	RESTORE

EVENT SERVICE

EN	FR	GE	IT	SP	SW
EV STATE	ETAT EVT	EREIGNIS	STATO EV	ESTD EVEN	HÅ.TILLS

12.PROMPTS TRANSLATIONS

MMI SERVICE

EN	FR	GE	IT	SP	SW
DIS TEST	TEST AFF	ANZ TEST	TEST IND	PRBA DIS	TEST VISU

CURRENT OUTPUT SERVICE

EN	FR	GE	IT	SP	SW
CUR 0%	mA 0%	mA 0%	mA 0%	0% mA	0% mA
CUR 100%	mA 100%	mA 100%	mA 100%	100% mA	mA 100%

12.PROMPTS TRANSLATIONS

12.3 MESSAGES DURING RUN DISPLAY

HOLD MESSAGES

EN	FR	GE	IT	SP	SW
DISPLAY SCAN	SCRUTAT	DURCHLAUF	DISPLAY SCAN	BARRIDO VP	DISPLAY SCAN
HOLD ON #	VUE FIXE	FIXIERE Nr.	# VIA SCELTA	DETENRBARR	no STANNA

PRINT MESSAGES

EN	FR	GE	IT	SP	SW
PRINT TIME	IMP HEURE	DRUCKE ZEIT	TEMPO STAMPA	HORA IMPRES	UTSIKT TID
PRINT VALUES	IMP VAL	DRUCKE WERTE	STP VALORI	IMPRIMIR VAL	UTSIKT VÄRD
CHART HOLD	DIAG FIXE	VORSCHUB AUS	STP ARRESTO	DETENERPAPEL	PAPPER STOP
CHART RUN	DIAG AV	VORSCHUB AN	STAMPA ON	PAPELAVANZA	PAPPER DRIV.
SPEED/TAB #	VIT/no TAB	GESCHW/TAB Nr	CAMB VELOC #	VELOCIDAD IMP	HAST./TAB.NR
CHART ADV	AVANCE	MAN.VORSCHUB	AVANZ CARTA	AVANZMANPAP	PAPPER ANV.
PAPLG	LONG DIAG	VORRAT	LUNG CARTA	LONGITUPAPEL	PAPPER LANGD

RESET MESSAGES

EN	FR	GE	IT	SP	SW
RESET MATH #	RAZ MATH no	RESETMATHENr	RESET MAT #	REINICMAT no	RESET MATEM
ALL MATH	TOUS MATHS	VOLLSTÄNDIG	RES TUT MATE	REINICOMPLET	ALLA MATEM
RESET BATCH	RAZ LOT	RESET NOTIZ	RESET BATCH	REINIC BATCH	RESET SPARA
INCR BATCH	INCR LOT	NÄCHSTENOTIZ	INCR BATCH	INCREM BATCH	TILL. SPARA

HOLD MESSAGES (adding)

EN	FR	GE	IT	SP	SW
SCAN #&#	SCRUT no &no	ZEIGE Nr & Nr	SCAN #&#	LEER no &no	SKANNA

13. CONFIGURATION WORKSHEET

13.1 ANALOG INPUTS

Factory configuration	Thermocouple	J-50/150oC	None	0	-50	+ 150	No Burnout	No	No	0
CH #	SENSOR	RANGE	T/C COMP	FILTER	LOW VAL	HIGH VAL	BURN OUT	STD MATH	CH #	ZERO ADJUST
1										
2										
3										
4										
5										
6										

13.2 ANALOG ALARMS

Factory configuration	0	0	0	1	None	1	No Relay	None	#1	Red	No	No
CH #	SP VALUE	HYST ERES	OCCUR NCE	CHANN EL	AL TYPE	CH DIFF	RELAY#	ACTION	MESS AG#	MSG COL	PRNT MSG	AL= RED
1												
2												
3												
4												
5												
6												
7												
8												
9												
10												
11												
12												

13. CONFIGURATION WORKSHEET

13.3 MATH

Factory configuration	No	2.000	2.000	2.000	CH 1	CH 2	CH 3	Logic 1 closed	Logic 1 opened	Enable
CH #	FUNCTION	COEF A	COEF B	COEF C	VAR A	VAR B	VAR C	START	RESET	BACKUP
1										
2										
3										
4										
5										
6										

13.4 DIGITAL INPUTS

Factory configuration	None	DI. 1	None	No	#1	Red	No message	Disable	No
CH #	TYPE	CH DIFF	ACTION	RELAY #	MESSAG#	MSG COL	PRNT MSG	TR COLOR	RED TRAC
1									
2									
3									
4									

13. CONFIGURATION WORKSHEET

13.5 MESSAGES

Factory configuration	No MESSAGE											
	MESSAGE #											
1												
2												
3												
4												
5												
6												
7												
8												
9												
10												
11												
12												

13.6 CHART

Factory Configuration	No Tag				No Eng. U				-50	+	*	-50	+	**	0 to 100 %	Ana-log In-put #	With RG1	
CH #	TAG NAME				ENG UNIT				DECI MAL	MIN RG1	MAX RG1	RG1 COL	MIN RG2	MAX RG2	RG2 COL	ZON ING	TRA CE	RG USED
1																		
2																		
3																		
4																		
5																		
6																		

13. CONFIGURATION WORKSHEET

*Pen : same as ink cartridge

** Mpt : CH1 = purple CH2 = red CH3 = black CH4 = green CH5 = blue CH6 = brown

Factory Configuration	No Tag				No Eng. U					-50	+	*	-50	+	**	0 to 100 %	Ana-log In-put #	With RG1
CH #	TAG NAME				ENG UNIT				DECI MAL	MIN RG1	MAX RG1	RG1 COL	MIN RG2	MAX RG2	RG2 COL	ZON ING	TRA CE	RG USED
1																		
2																		
3																		
4																		
5																		
6																		

13.7 MISCELLANEOUS

Factory configuration	*	*	**	1	+ 50	None	None	None	Conf 1
	TIME	DATE	LANGUAGE	IDNTIF #	FREQUNCY	PSSWRD 1	PSSWRD 2	MATH PAK	USE CONF

*Time / Date

**According to Operator Manual

13.8 BATCH

Factory configuration	None	No Reset	Enable	1	No	No	No	No
	START	RESET	BACKUP	BATCH #	LINE 1	LINE 2	LINE 3	LINE 4

↑ ↑ ↑ ↑

14 digits max.

13. CONFIGURATION WORKSHEET

13.9 PRINTER

Factory configuration		
Roll = 2400 Fanfold 1800 0	CHART LG	
mm/h	SPD UNIT	
60	SPE-ED 1	
120	SPE-ED 2	
SPD 1	SPD USED	
	TABU- LAR 1	
	TABU- LAR 2	
Print	REC MODE	
Trend	PRT MODE	
120 mm	PRT INTV	
Enable	PRT PV	
Enable	PRT RANG	
Enable	PRT TIME	
Disable	PRT TAG	
Disable	PEN OFFS	

13. CONFIGURATION WORKSHEET

13.10 EVENT

Factory configuration		No relay	Enable
	TYPE	RELAY #	DISPLAY
1	Cassette out		
2	End Paper		
3	Battery		
4	Alarm		
5	Burnout		
6	Shed time		

(except Shed time)

13.11 MMI

Factory configuration	Enable	Enable	Enable	Disable	True	80%
	KEY DOWN	KEY UP	KEY LEFT	KEY RIGH	DISPLAY	BRIGHT

13.12 CURRENT OUTPUT

Factory configuration			
OUT-PUT	CH #	LOW VAL	HIGH VAL
1			
2			

SIKKERHEDSKRAV

DA2I-6002



For at undgå elektrisk stød med mulighed for personskade, skal alle sikkerhedsbestemmelser i denne manual følges nøje.



Beskyttende jordterminal. Terminalen er forberedt for og skal forbindes til beskyttelses-jordledning i henhold til stærkstrømsbekendtgørelsen (DK).

- Hvis udstyret ikke bruges som specificeret i manualen, kan den beskyttelse udstyret yder blive nedsat eller forsvinde.
- Erstat kun komponenter som udtrykkeligt er specificeret som udskiftelige i manualen.
- Al ledningsforbindelse skal følge strækstrømsbekendtgørelsen (DK) og udføres af autoriseret erfarent personel.
- Den beskyttende jordterminal skal forbindes først af alle forbindelser (og fjernes som den sidste).
- Jvf. stærkstrømsreglementet skal der installeres en afbryder til forsyningsspændingen nær udstyret.
- Hver leder skal have ekstra beskyttelse ifølge stærkstrømsbekendtgørelsen (DK).

UDSTYRS SPECIFIKATIONER

Strømforsyning : 85 til 264 V AC

Frekvens : 50/60 Hz

Effektforbrug : 55 VA max.

OMGIVELSE SPECIFIKATIONER

Placer ikke udstyret i nærheden af brandbare væsker eller dampe.

Fugtighed	Rullepapir	10 - 90 % RH ikke kondenserende
	Foldepapir	15 - 80 % RH ikke kondenserende
Temperatur	Drift	0 til 50°C (32 til 120°F)
	Opbevaring	-40 til 70°C (-40 til 160°F)
Vibrationer	Frekvens	10 til 60 Hz, amplitude 0.07 mm
		60 til 150 Hz, acceleration 1 g

UDSTYRS INSTALLATION

Skrivere skal monteres i en tavle for at forhindre adgang til bagterminaler.

(Maksimal tavletykkelse 15 mm)

INSTRUKTION FOR RENGØRING

Brug kun en tør bomuldklud til rengøring af udstyret.

UDSKIFTNING AF SIKRING

Sikring : For at forebygge brand, vær sikker på at sikringen opfylder kravene til strøm, spænding og karakteristik. Sluk for spændingen før sikringen udskiftes. Brug ikke en sikring af anden type.

VEILIGHEIDSVEREISTEN

DU2I-6002



Ter vermindering van het gevaar van elektrische schokken die lichamelijk letsel kunnen veroorzaken, dient u alle veiligheidsaanwijzingen in dit document te volgen.



Beschermende aarde-aansluiting. Bestemd voor aansluiting van de aardingsdraad van de voeding.

- Indien de apparatuur wordt gebruikt anders dan door de fabrikant gespecificeerd, kan de bescherming, die de apparatuur biedt ongedaan worden gemaakt.
- Alleen die onderdelen mogen worden vervangen die door de fabrikant als uitwisselbaar zijn aangemerkt.
- Alle bedrading moet in overeenstemming zijn met plaatselijke standaards en zijn uitgevoerd door geautoriseerd ervaren personeel.
- De aardingsdraad moet worden aangesloten vóórdat alle andere bedrading wordt aangesloten (en als laatste worden verbroken).
- Een schakelaar in de netstroomtoevoer is vereist, vlakbij het instrument.
- Elke stroomdraad moet beveiligd zijn met een zekering gelijkwaardig aan zowel de recorderzekering (zekering type) als die van de zekeringhouder.

Apparatuur voorwaarden

Aansluitspanning: 85 tot 264 V AC

Frequentie: 50/60 Hz

Toegestane belasting: 55 VA max.

Omgevingscondities

Gebruik het instrument niet in de aanwezigheid van ontvlambare vloeistoffen of dampen. Het gebruik van elk elektrisch instrument in een dergelijke omgeving vormt een gevaar voor uw veiligheid.

Relatieve vochtigheid	Rol	10 tot 90 % RH niet condenserend
	Vouwkaart	15 tot 80 % RH niet condenserend
Temperatuur	Omgevingstemp.	0 tot 50°C (32 tot 120°F)
	Opslag	-40 tot 70°C (-40 tot 160°F)
Trillingen	Frequentie	10 tot 60 Hz, amplitude 0.07 mm
		60 tot 150 Hz, versnelling 1 g

Montage van de apparatuur

De recorder moet worden gemonteerd in een paneel om de toegankelijkheid tot de achterste aansluitpunten te beperken (paneeldikte maximaal 15 mm)

Schoonmaken

Alleen een droge katoenen doek gebruiken voor het schoonmaken van het instrument.

Vervanging van verbruiksmaterialen

Zekering: ter voorkoming van brand dient u de zekering met de gespecificeerde standaard te gebruiken (stroomspanning, type). Voor u de zekering vervangt moet u de netspanning uitschakelen en de stroomtoevoer onderbreken. Gebruik geen andere zekering en sluit de zekeringhouder niet kort.

TURVALLISUUSMÄÄRÄYKSET

FI2I-6002



Noudata tämän ohjeen kaikkia turvaohjeita välttääksesi sähkötapaturman vaaraa.



Suojamaaliitin. Kytke maadoitusjohdin tähän liittimeen.

- Jos laitetta käytetään olosuhteissa, joihin sitä ei ole suunniteltu, käyttöturvallisuus voi heikentyä.
- Älä vaihda mitään komponenttia tai osaa, jota valmistaja ei ole määritellyt käyttäjän vaihdettavaksi.
- Johdotukset on tehtävä noudattaen paikallisia määräyksiä ja tekijällä on oltava riittävä ammattitaito.
- Ensimmäiseksi on kytkettävä suojamaa-liitin (ja viimeiseksi irroitettava).
- Syöttöjännitekytkin on sijoitettava lähelle laitetta.
- Suojaa johtimet asianmukaisilla sulakkeilla.

LAITTEEN VAATIMUKSET

Syöttöjännite: 85 ... 264 V AC

Taajuus: 50/60 Hz

Tehonkulutus: 55 VA max.

KÄYTTÖOLosuhteet

Älä käytä laitetta paikassa jossa on syttyviä nesteitä tai kaasuja, koska laitteen käyttö aiheuttaa räjähdysvaaran.

Kosteus	Rulla	10 ... 90 % RH non condensing
	Laskostuva	15 ... 80 % RH non condensing
Lämpötila	Käyttö	0 ... 50 ast. C (32 ... 120 ast. F)
	Varastointi	-40 ... 70 ast. C (-40 ... 160 ast. F)
Tärinä	Taajuus	10 ... 60 Hz, amplitude 0.07 mm
		60 ... 150 Hz, kiihtyvyys 1 g

LAITTEEN ASENNUS

Piirturi on asennettava paneeliin siten, että peräliittimille jää riittävästi tilaa.

(Paneelin maksimi paksuus 15 mm)

PUHDISTUSOHJEET

Käytä vain kuivaa puuvillakangasta laitteen puhdistukseen.

KULUTUSOSIEN VAIHTAMINEN

Käytä aina oikean tyyppistä sulaketta (virta, jännite, tyyppi). Katkaise syöttöjännite laitteesta ennen sulakkeen vaihtoa. Älä käytä ohjeista poikkeavaa sulaketta tai oikosulje sulakepesää.

ΑΠΑΙΤΗΣΕΙΣ ΑΣΦΑΛΕΙΑΣ

GR21-6002



ΓΙΑ ΝΑ ΜΕΙΩΘΕΙ Ο ΚΙΝΔΥΝΟΣ ΗΛΕΚΤΡΟΠΛΗΞΙΑΣ Η ΟΠΟΙΑ ΜΠΟΡΕΙ ΝΑ ΠΡΟΚΑΛΕΣΕΙ ΤΡΑΥΜΑΤΙΣΜΟ, ΑΚΟΛΟΥΘΗΣΤΕ, ΟΛΕΣ ΤΙΣ ΟΔΗΓΙΕΣ ΑΣΦΑΛΕΙΑΣ ΠΟΥ ΠΑΡΑΤΙΘΕΝΤΑΙ Σ' ΑΥΤΟ ΤΟ ΦΥΛΛΑΔΙΟ.



ΠΡΟΣΤΑΤΕΥΤΙΚΗ ΓΕΙΩΣΗ ΠΑΡΕΧΕΤΑΙ ΓΙΑ ΤΗΝ ΣΥΝΔΕΣΗ ΜΕ ΤΟ ΣΥΣΤΗΜΑ ΓΕΙΩΣΗΣ ΤΗΣ ΕΓΚΑΤΑΣΤΑΣΗΣ.

- ΑΝ Η ΣΥΣΚΕΥΗ ΧΡΗΣΙΜΟΠΟΙΗΘΕΙ ΜΕ ΤΡΟΠΟ ΠΟΥ ΔΕΝ ΣΥΜΦΩΝΕΙ ΜΕ ΤΙΣ ΟΔΗΓΙΕΣ ΤΟΥ ΚΑΤΑΣΚΕΥΑΣΤΗ ΠΙΘΑΝΟΝ ΝΑ ΜΕΙΩΘΕΙ Η ΠΡΟΣΤΑΣΙΑ ΠΟΥ ΠΡΟΣΦΕΡΕΙ.
- ΝΑ ΜΗΝ ΑΝΤΙΚΑΘΙΣΤΑΤΑΙ ΚΑΝΕΝΑ ΕΞΑΡΤΗΜΑ Η/ ΤΜΗΜΑ ΤΟΥ ΟΡΓΑΝΟΥ ΠΟΥ ΔΕΝ ΑΝΑΦΕΡΕΤΑΙ ΣΑΦΩΣ ΑΠΟ ΤΟΝ ΚΑΤΑΣΚΕΥΑΣΤΗ ΩΣ ΑΝΤΑΛΛΑΞΙΜΟ.
- ΟΛΕΣ ΟΙ ΚΑΛΩΔΙΩΣΕΙΣ ΠΡΕΠΕΙ ΝΑ ΕΙΝΑΙ ΣΥΜΦΩΝΕΣ ΜΕ ΤΗΝ ΤΟΠΙΚΗ ΝΟΜΟΘΕΣΙΑ ΚΑΙ Η ΕΓΚΑΤΑΣΤΑΣΗ ΤΟΥΣ ΠΡΕΠΕΙ ΝΑ ΓΙΝΕΙ ΑΠΟ ΕΙΔΙΚΕΥΜΕΝΟ ΚΑΙ ΕΜΠΕΙΡΟ ΠΡΟΣΩΠΙΚΟ.
- Η ΓΕΙΩΣΗ ΠΡΕΠΕΙ ΝΑ ΣΥΝΔΕΘΕΙ ΠΡΙΝ ΑΠΟ ΟΠΟΙΑΔΗΠΟΤΕ ΑΛΛΗ ΚΑΛΩΔΙΩΣΗ, ΚΑΙ ΤΕΛΕΥΤΑΙΑ ΚΑΤΑ ΤΗΝ ΑΠΟΣΥΝΔΕΣΗ.
- ΕΝΑΣ ΔΙΑΚΟΠΤΗΣ ΤΗΣ ΚΥΡΙΑΣ ΠΑΡΟΧΗΣ ΑΠΑΙΤΕΙΤΑΙ ΚΟΝΤΑ ΣΤΟ ΟΡΓΑΝΟ.
- ΚΑΘΕ ΚΑΛΩΔΙΟ ΠΡΕΠΕΙ ΝΑ ΠΡΟΣΤΑΤΕΥΕΤΑΙ ΑΠΟ ΑΣΦΑΛΕΙΑ ΙΣΟΔΥΝΑΜΗ ΜΕ ΤΗΝ ΑΣΦΑΛΕΙΑ ΤΟΥ ΚΑΤΑΓΡΑΦΙΚΟΥ, ΚΑΘΩΣ ΕΠΙΣΗΣ ΚΑΙ ΜΕ ΑΣΦΑΛΕΙΟΘΗΚΗ.

ΤΕΧΝΙΚΑ ΣΤΟΙΧΕΙΑ ΟΡΓΑΝΟΥ

ΤΡΟΦΟΔΟΣΙΑ : 85 - 264 V ac

ΣΥΧΝΟΤΗΤΑ : 50/60 Hz

ΙΣΧΥΣ : 55 VA ΜΕΓΙΣΤΗ

ΣΥΝΘΗΚΕΣ ΠΕΡΙΒΑΛΛΟΝΤΟΣ

ΝΑ ΜΗΝ ΧΡΗΣΙΜΟΠΟΙΕΙΤΑΙ ΤΟ ΟΡΓΑΝΟ ΣΕ ΧΩΡΟΥΣ ΜΕ ΠΑΡΟΥΣΙΑ ΕΥΔΕΚΤΩΝ ΥΓΡΩΝ Η ΑΤΜΩΝ. ΧΡΗΣΗ ΟΠΟΙΟΥΔΗΠΟΤΕ ΗΛΕΚΤΡΙΚΟΥ ΟΡΓΑΝΟΥ ΣΕ ΤΕΤΟΙΟ ΠΕΡΙΒΑΛΛΟΝ ΑΠΟΤΕΛΕΙ ΚΙΝΔΥΝΟ ΑΤΥΧΗΜΑΤΟΣ.

ΥΓΡΑΣΙΑ	ΧΑΡΤΙ ΡΟΛΛΟ ΧΑΡΤΙ ΔΙΠΛΩΜΕΝΟ	10 - 90 % RH ΜΗ ΣΥΜΠΥΚΝΩΜΕΝΗ 15 - 80 % RH ΜΗ ΣΥΜΠΥΚΝΩΜΕΝΗ
ΘΕΡΜΟΚΡΑΣΙΑ	ΠΕΡΙΒΑΛΛΟΝΤΟΣ ΑΠΟΘΗΚΕΥΣΗΣ	0 / 50 DEG C (32 / 120 DEG F) - 40 / 70 DEG C (-40 / 160 DEG F)
ΤΑΛΑΝΤΩΣΗ	ΣΥΧΝΟΤΗΤΑ	10 - 60 Hz, ΜΕΓΕΘΟΣ 0.07 mm 60 - 150 Hz, ΕΠΙΓΑΧΥΝΣΗ 1 g

ΤΟΠΟΘΕΤΗΣΗ ΜΗΧΑΝΗΜΑΤΟΣ

ΤΟ ΚΑΤΑΓΡΑΦΙΚΟ ΟΡΓΑΝΟ ΠΡΕΠΕΙ ΝΑ ΤΟΠΟΘΕΤΗΘΕΙ ΣΤΗΝ ΠΡΟΣΟΨΗ ΤΟΥ ΠΙΝΑΚΑ, ΕΤΣΙ ΩΣΤΕ ΝΑ ΜΗΝ ΜΠΟΡΕΙ Ο ΧΕΙΡΙΣΤΗΣ ΝΑ ΕΧΕΙ ΠΡΟΣΒΑΣΗ ΣΤΟ ΠΙΣΩ ΜΕΡΟΣ, ΜΕΓΙΣΤΟ ΠΑΧΟΣ ΠΙΝΑΚΟΣ 15 mm.

ΟΔΗΓΙΕΣ ΚΑΘΑΡΙΣΜΟΥ

ΧΡΗΣΙΜΟΠΟΙΗΣΤΕ ΜΟΝΟ ΕΝΑ ΣΤΕΓΝΟ ΒΑΜΒΑΚΕΡΟ ΥΦΑΣΜΑ ΓΙΑ ΤΟΝ ΚΑΘΑΡΙΣΜΟ ΤΟΥ ΟΡΓΑΝΟΥ.

ΑΝΤΙΚΑΤΑΣΤΑΣΗ ΑΝΑΛΩΣΙΜΟΥ ΥΛΙΚΟΥ

ΑΣΦΑΛΕΙΑ : ΠΡΟΣ ΑΠΟΦΥΓΗ ΠΥΡΚΑΙΑΣ Η ΑΣΦΑΛΕΙΑ ΘΑ ΠΡΕΠΕΙ ΝΑ ΑΝΤΙΚΑΘΙΣΤΑΤΑΙ ΜΕ ΝΕΑ, ΒΑΣΗ ΤΩΝ ΠΡΟΤΕΙΝΟΜΕΝΩΝ ΠΡΟΔΙΑΓΡΑΦΩΝ (ΤΑΣΗ, ΕΝΤΑΣΗ, ΤΥΠΟΣ). ΠΡΙΝ ΑΠΟ ΤΗΝ ΑΝΤΙΚΑΤΑΣΤΑΣΗ ΝΑ ΔΙΑΚΟΠΤΕΤΑΙ Η ΠΑΡΟΧΗ ΤΑΣΗΣ Η/ ΝΑ ΑΠΟΣΥΝΔΕΕΤΑΙ Η ΚΑΛΩΔΙΩΣΗ ΠΑΡΟΧΗΣ. ΝΑ ΜΗΝ ΧΡΗΣΙΜΟΠΟΙΗΓΑΙ ΑΣΦΑΛΕΙΑ ΔΙΑΦΟΡΕΤΙΚΗ ΑΠΟ ΤΗΝ ΠΡΟΤΕΙΝΟΜΕΝΗ, ΚΑΙ ΝΑ ΜΗΝ ΒΡΑΧΥΚΥΚΛΩΝΕΤΑΙ Η ΑΣΦΑΛΕΙΟΘΗΚΗ.

Instruções de segurança

PO2I-6002



Para reduzir o risco de choque eléctrico que pode causar danos corporais, seguir todas as normas de segurança contidas nesta documentação.



Terminal de protecção de terra. Fornecido para ligação do condutor do sistema da protecção de terra.

- Se este equipamento for usado de modo não especificado pelo fabricante, a protecção fornecida pelo equipamento pode não ser adequada.
- Não se deve substituir qualquer componente (ou peça) que não seja explicitamente especificado como substituível pelo nosso revendedor.
- Toda a cabelagem tem que estar de acordo com as normas locais e deve ser conduzida por pessoal autorizado com experiência.
- O terminal de terra deve ser ligado antes de ser feita qualquer outra cabelagem (e desligado em último lugar).
- Deve haver um interruptor da alimentação principal junto do equipamento.
- Cada fio deve estar protegido com um fusível equivalente ao do Registador (tipo de fusível), o mesmo se aplicando ao suporte do fusível.

Especificações do Equipamento

Voltagem: 85 a 264 Vca

Frequência: 50/60 Hz

Potência ou consumo de Corrente: 55 VA max.

Condições Ambientais

Não operar o instrumento na presença de líquidos ou vapores inflamáveis. A operação de qualquer instrumento eléctrico em tal ambiente constitui um perigo para a segurança.

Humidade	Rolo	10 a 90 % RH não condensado
	Leque	15 a 80 % RH não condensado
Temperatura	Ambiente	0 a 50°C (32 a 120°F)
	Armazenagem	-40 a 70°C (-40 a 160°F)
Vibrações	Frequência	10 a 60 Hz, amplitude de 0.07 mm
		60 a 150 Hz, 1g de aceleração

Instalação do Equipamento

O Registador deve ser montado num painel para limitar o acesso do operador aos terminais traseiros (espessura máxima do painel 15 mm).

Instruções de Limpeza

Usar apenas um cotonete seco para limpar a unidade.

Substituição de Consumíveis

Fusível: Para evitar um incêndio certifique-se de que usa um fusível com especificações standard (voltagem, corrente, tipo). Antes de substituir o fusível, desligue a alimentação e desligue os fios da fonte de alimentação. Não usar fusíveis diferentes ou fazer curto circuito do suporte de fusível.

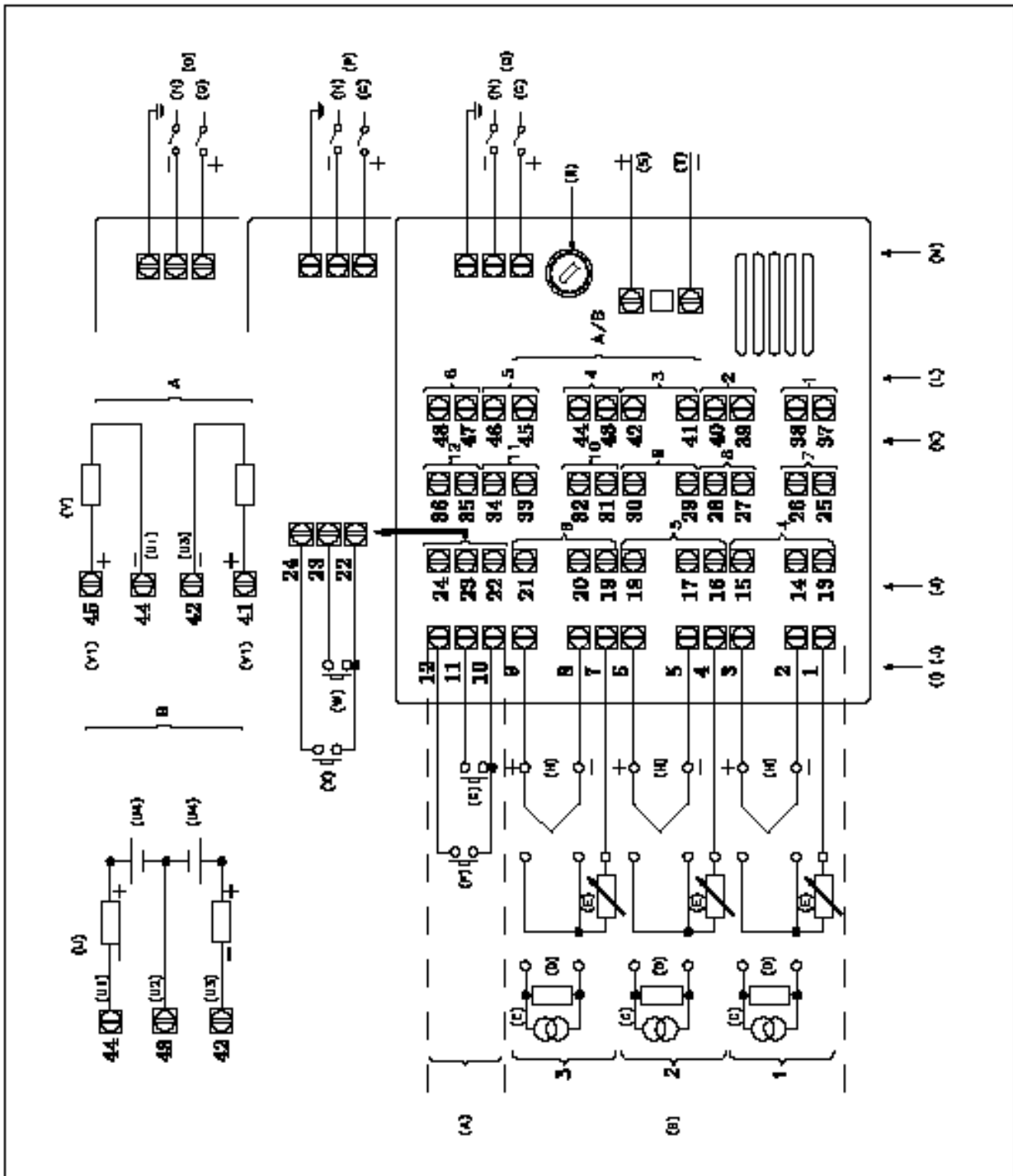

PQ

- (A) Entradas lógicas
- (B) Entradas analógicas
- (C) mA
- (D) 250 ohms
- (E) RTD
- (F) L2
- (G) L1
- (H) T/C, mV, V
- (I) Entradas analógicas para registor de caneta
- (J) Entradas analógicas para registor multiponto
- (K) 7 a 12 saídas de alarme
- (L) 1 a 6 saídas de alarme ou 1 a 2 saídas corrente
- (M) Fonte de alimentação
- (N) L2/N
- (O) 24 V ca/cc
- (P) 48 V ca/cc
- (Q) 100 a 240 V ca/cc
- (R) Fusível de 100 a 240 V ca = 1 A
24 ou 48 V ca/cc = 3.2 A
- (S) Saída de 24 V cc
- (T) Máximo de 75 mA
- (U) Gerador externo
- (U1) OUT 2
- (U2) 0 V
- (U3) OUT 1
- (U4) 24 V DC max.
- (V) Gerador interno
- (V1) +12 V
- (W) L3
- (X) L4

DU

- (A) Logische ingangen
 - (B) Analoge ingangen
 - (C) mA
 - (D) 250 ohm
 - (E) RTD
 - (F) L2
 - (G) L1
 - (H) T/C, mV, V
 - (I) Analoge ingangen, pen recorder
 - (J) Analoge ingangen, meerpunts recorder
 - (K) 7 tot 12 alarm uitgangen
 - (L) 1 tot 6 alarm uitgangen of 1 tot 2 stroom uitgangen
 - (M) Netvoeding
 - (N) L2/N
 - (O) 24 V AC/DC
 - (P) 48 V AC/DC
 - (Q) 100 tot 240 V AC/DC
 - (R) Zekering 100 tot 240 V AC = 1 A
24 of 48 V AC/DC = 3.2 A
 - (S) 24 V DC uitgang
 - (T) 75 mA max.
 - (U) Externe generator
 - (U1) OUT 2
 - (U2) 0 V
 - (U3) OUT 1
 - (U4) 24 V DC max.
 - (V) Interne generator
 - (V1) +12 V
 - (W) L3
 - (X) L4
-

GR

- (A) ΛΟΓΙΚΗ ΕΙΣΟΔΟΣ
- (B) ΑΝΑΛΟΓΙΚΗ ΕΙΣΟΔΟΣ
- (C) mA
- (D) 250 ohms
- (E) RTD
- (F) L2
- (G) L1
- (H) T/C, mV, V
- (I) ΑΝΑΛΟΓΙΚΕΣ ΕΙΣΟΔΟΙ ΚΑΤΑΓΡΑΦΙΚΗΣ ΠΕΝΝΑΣ
- (J) ΑΝΑΛΟΓΙΚΕΣ ΕΙΣΟΔΟΙ ΚΑΤΑΓΡΑΦΙΚΟΥ ΠΟΛΛΑΠΛΩΝ ΕΙΣΡΑΦΩΝ
- (K) 7 - 12 ΣΥΝΑΓΕΡΜΟΙ ΕΞΟΔΟΥ
- (L) 1 - 6 ΣΥΝΑΓΕΡΜΟΙ ΕΞΟΔΟΥ Η΄
1 - 2 ΡΕΥΜΑΤΑ ΕΞΟΔΟΥ
- (M) ΤΡΟΦΟΔΟΣΙΑ
- (N) L2/N
- (O) 24 V AC/DC
- (P) 48 V AC/DC
- (Q) 100 - 240 V AC/DC
- (R) ΑΣΦΑΛΕΙΑ
- (S) ΕΞΟΔΟΣ ΣΥΝΕΧΗΣ ΤΑΣΗΣ
- (T) ΕΞΩΤΕΡΙΚΗ / ΕΣΩΤΕΡΙΚΗ ΤΡΟΦΟΔΟΣΙΑ
- (U) ΕΞΩΤΕΡΙΚΗ ΓΕΝΝΗΤΡΙΑ
- (U1) OUT 2
- (U2) 0 V
- (U3) OUT 1
- (U4) 24 V DC max.
- (V) ΕΣΩΤΕΡΙΚΗ ΓΕΝΝΗΤΡΙΑ
- (V1) +12 V
- (W) L3
- (X) L4

DA

- (A) Logiske indgange
 - (B) Analoge indgange
 - (C) mA
 - (D) 250 Ohm
 - (E) RTD (PT 100)
 - (F) L2
 - (G) L1
 - (H) T/C, mV, V
 - (I) Analoge indgange lineskriver
 - (J) Analoge indgange multipunktskriver
 - (K) 7 til 12 alarm udgange
 - (L) 1 til 6 alarm udgange eller 1 til 2 strømudgange
 - (M) Strømforsyning
 - (N) L2/N
 - (O) 24 V AC/DC
 - (P) 48 V AC/DC
 - (Q) 100 - 240 V AC/DC
 - (R) Sikring 100 - 240 V AC = 1 A
24 eller 48 V AC/DC = 3.2 A
 - (S) 24 V DC udgang
 - (T) 75 mA max.
 - (U) Extern generator
 - (U1) OUT 2
 - (U2) 0 V
 - (U3) OUT 1
 - (U4) 24 V DC max.
 - (V) Intern generator
 - (V1) +12 V
 - (W) L3
 - (X) L4
-

EL

- (A) Logiikkatulot
 - (B) Analogiatulot
 - (C) mA
 - (D) 250 ohms
 - (E) RTD
 - (F) L2
 - (G) L1
 - (H) T/C, mV, V
 - (I) Analogiatulot kynäpiirturi
 - (J) Analogiatulot monipistepiirturi
 - (K) 7 ... 12 hälytyslähdöt
 - (L) 1 ... 6 hälytyslähdöt tai 1 ... 2 virtalähdöt
 - (M) Jännitelähde
 - (N) L2/N
 - (O) 24 V AC/DC
 - (P) 48 V AC/DC
 - (Q) 100 ... 240 V AC/DC
 - (R) Sulake 100 ... 240 V AC = 1 A
24 tai 48 V AC/DC = 3.2 A
 - (S) 24 V DC lähtö
 - (T) 75 mA max.
 - (U) External generator
 - (U1) OUT 2
 - (U2) 0 V
 - (U3) OUT 1
 - (U4) 24 V DC max.
 - (V) Internal generator
 - (V1) +12 V
 - (W) L3
 - (X) L4
-

Sales and Service

For application assistance, current specifications, pricing, or name of the nearest Authorized Distributor, contact one of the offices below.

ARGENTINA

Honeywell S.A.I.C.
Belgrano 1156
Buenos Aires
Argentina
Tel. : 54 1 383 9290

ASIA PACIFIC

Honeywell Asia
Pacific Inc.
Room 3213-3225
Sun Kung Kai Centre
N° 30 Harbour Road
Wanchai
Hong Kong
Tel. : 852 829 82 98

AUSTRALIA

Honeywell Limited
5 Thomas Holt Drive
North Ryde Sydney
Nsw Australia 2113
Tel. : 61 2 353 7000

AUSTRIA

Honeywell Austria
G.M.B.H.
Handelskai 388
A1020 Vienna
Austria
Tel. : 43 1 727 800

BELGIUM

Honeywell S.A.
3 Avenue De Bourget
B-1140 Brussels
Belgium
Tel. : 32 2 728 27 11

BRAZIL

HONEYWELL DO
Brazil
And Cia
Rua Jose Alves Da
Chunha
Lima 172
Butanta
05360.050 Sao Paulo
Sp
Brazil
Tel. : 55 11 819 3755

BULGARIA

HONEYWELL EOOD
14, Iskarsko Chausse
POB 79
BG- 1592 Sofia
BULGARIA
Tel. : 359-791512/
794027/ 792198

CANADA

Honeywell Limited
The Honeywell Centre
300 Yorkland Blvd.
Toronto, Ontario
M2j 1s1
Canada
Tel.: 800 461 0013
Fax:: 416 502 5001

CZECH REPUBLIC

HONEYWELL,
Spol.S.R.O.
Budejovicka 1
140 21 Prague 4
Czech Republic
Tel. : 42 2 6112 3434

DENMARK

HONEYWELL A/S
Automatikvej 1
DK 2860 Soeborg
DENMARK
Tel. : 45 39 55 56 58

FINLAND

HONEYWELL OY
Ruukintie 8
FIN-02320 ESPOO 32
FINLAND
Tel. : 358 0 3480101

FRANCE

HONEYWELL S.A.
Bâtiment « le Mercurey »
Parc Technologique de St
Aubin
Route de l'Orme
(CD 128)
91190 SAINT-AUBIN
FRANCE
Tel. from France:
01 60 19 80 00
From other countries:
33 1 60 19 80 00

GERMANY

HONEYWELL AG
Kaiserleistrasse 39
D-63067 OFFENBACH
GERMANY
Tel. : 49 69 80 64444

HUNGARY

HONEYWELL Kft
Gogol u 13
H-1133 BUDAPEST
HUNGARY
Tel. : 36 1 451 43 00

ICELAND

HONEYWELL
Hataekni .hf
Armuli 26
PO Box 8336
128 reykvjavik
Iceland
Tel. : 354 588 5000

ITALY

HONEYWELL S.p.A.
Via P. Gobetti, 2/b
20063 Cernusco Sul
Naviglio
ITALY
Tel. : 39 02 92146 1

MEXICO

HONEYWELL S.A. DE
CV
AV. CONSTITUYENTES
900
COL. LOMAS ALTAS
11950 MEXICO CITY
MEXICO
Tel. : 52 5 259 1966

THE NETHERLANDS

HONEYWELL BV
Laaderhoogweg 18
1101 EA AMSTERDAM
ZO
THE NETHERLANDS
Tel. : 31 20 56 56 911

NORWAY

HONEYWELL A/S
Askerveien 61
PO Box 263
N-1371 ASKER
NORWAY
Tel. : 47 66 76 20 00

POLAND

HONEYWELL Sp.z.o.o
Ul Domainewska 41
02-672 WARSAW
POLAND
Tel. : 48 22 606 09 00

PORTUGAL

HONEYWELL
PORTUGAL LDA
Edificio Suecia II
Av. do Forte nr 3 - Piso 3
2795 CARNAXIDE
PORTUGAL
Tel. : 351 1 424 50 00

REPUBLIC OF IRELAND

HONEYWELL
Unit 1
Robinhood Business
Park
Robinhood Road
DUBLIN 22
Republic of Ireland
Tel. : 353 1 4565944

REPUBLIC OF SINGAPORE

HONEYWELL PTE LTD
BLOCK 750E CHAI
CHEE ROAD
06-01 CHAI CHEE
IND.PARK
1646 SINGAPORE
REP. OF SINGAPORE
Tel. : 65 2490 100

REPUBLIC OF SOUTH AFRICA

HONEYWELL
Southern Africa
PO BOX 138
Milnerton 7435
REPUBLIC OF SOUTH
AFRICA
Tel. : 27 11 805 12 01

ROMANIA

HONEYWELL Office
Bucharest
147 Aurel Vlaicu Str.,
Sc.Z.,
Apt 61/62
R-72921 Bucharest
ROMANIA
Tel. : 40-1 211 00 76/
211 79

RUSSIA

HONEYWELL INC
4 th Floor Administrative
Building of AO "Luzhniki"
Management
24 Luzhniki
119048 Moscow
RUSSIA
Tel. : 7 095 796 98 00/01

SLOVAKIA

HONEYWELL Ltd
Mlynske nivy 73
PO Box 75
820 07 BRATISLAVA 27
SLOVAKIA
Tel. : 421 7 52 47
400/425

SPAIN

HONEYWELL S.A
Factory
Josefa Valcarcel, 24
28027 MADRID
SPAIN
Tel. : 34 91 31 3 61 00

SWEDEN

HONEYWELL A.B.
S-127 86 Skarholmen
STOCKHOLM
SWEDEN
Tel. : 46 8 775 55 00

SWITZERLAND

HONEYWELL A.G.
Hertistrasse 2
8304 WALLISELLEN
SWITZERLAND
Tel. : 41 1 831 02 71

TURKEY

HONEYWELL A.S.
Caryiryolu Sok No. 7
Ucgen Plaza, Kat 5-6-7
Icerenkoy 81120
Istanbul
Turkey
Tel (90-216) 575 66 00

UNITED KINGDOM

HONEYWELL
Newhouse Industrial Estate
Motherwell. ML1. 5SB
Scotland. UK.
Tel: +44 (0)1698 481481
Fax: +44 (0) 1698
481276

U.S.A.

HONEYWELL INC.
INDUSTRIAL PROCESS
CONTROLS
1100 VIRGINIA DRIVE
PA 19034-3260
FT. WASHINGTON
U.S.A.
Tel. : 1-800-343-0228

VENEZUELA

HONEYWELL CA
APARTADO 61314
1060 CARACAS
VENEZUELA
Tel. : 58 2 239 0211