

How to Select and Specify

Not all optional features are appropriate or available for all valves.

Table 1 lists the optional electrical feature prefixes available for each Red-Hat II® solenoid and coil. Specify these features by adding the indicated prefixes to the valve catalog number.

For those prefixes marked with a “•” or for optional Red-Hat® electrical features not covered here, contact your local ASCO sales office.

Table 2 lists the suffixes for optional construction features available for each valve Series. Specify these features by adding the indicated suffixes to the valve catalog number.

Table 1: Optional Red-Hat II® Electrical Feature Prefixes (For Red-Hat® optional electrical features, contact your local sales office.)

Code	Solenoid
EF	Type 7 Explosionproof
EV	Type 7 Explosionproof with 316 Stainless Steel Hub and Stainless Steel Base Plate
GP	Panel Mount Type 1 General Purpose Solenoid
J	Junction Box
JP	Panel Mount Junction Box
OF	Open Frame Spade and Screw Terminal Solenoids
OP	Panel Mount Spade, Screw and DIN Terminal Solenoids
Code	Coil
HB	Class H - Intermediate Power
• HC	Class H - Battery Charging Coil
HT	Class H - High Temperature
KB	Class H - Intermediate Power - Screw Terminals
• KC	Class H - Battery Charging Circuit - Screw Terminals
KF	Class F - High Temperature - Screw Terminals
KH	Class H - High Temperature - Screw Terminals
KP	Class F - Intermediate Power - Screw Terminals
SC	Class F - High Temperature - DIN Connection
SD	Class F - Intermediate Power - DIN Connection
SF	Class F - High Temperature - Spade Terminals
SP	Class F - Intermediate Power - Spade Terminals
SS	Class H - Intermediate Power - Spade Terminals
ST	Class H - High Temperature - Spade Terminals
SU	Class H - High Temperature - DIN Connection
SV	Class H - Intermediate Power - DIN Connection
• SW	Class H - Battery Charging Circuit - Spade Terminals
Code	Feature
• L	72" continuous leads
• X	Other special constructions

Table 2: Suffixes for Optional Construction Features

SUFFIX I		SUFFIX II		SUFFIX III	
Code	Seat/Disc/Etc. Material	Code	Form of Flow	Code	Feature
E	EPDM (Ethylene Propylene)	† F	Normally Closed	† HW	Hot Water Construction
J	CR (Neoprene)	† G	Normally Open	† LT	Low Temperature
† K	Air Operated, 3-30 psi	† U	Universal	M	Metering Device
N	Oxygen			† MB	Mounting Bracket
† Q	Long-Life Construction			MO	Manual Operator
† R	Resilient			MS	Screw Type Manual Operator
T	PTFE (Teflon*)			† VH	High Vacuum
V	FPM (Viton*)			† VM	Medium Vacuum

† Covered on the pages of the Series in which it is used.
* DuPont Co. trademark.

Note: See chart on page 10.02 for specific power and temperature ratings.

An example of an ASCO valve catalog number with prefixes and suffixes:

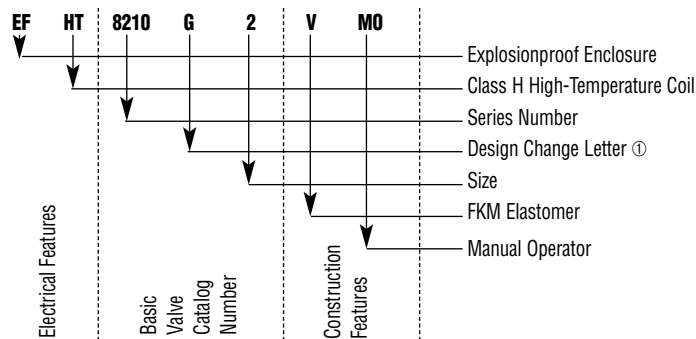

① The Design Change Letter indicates a major design change affecting spare parts kits, rebuild kits, and coils. The correct replacement parts for each change letter are shown in ASCO's Rebuild Kits and Coils Catalog.

Optional Electrical Features

Most optional electrical features shown here can be included on ASCO valves approved by UL, FM, and CSA.

Identify the options you want by adding the appropriate prefix to the catalog number of the valve you are specifying.

To determine the proper prefix, use the Valve Series Specification Table for the valve you are ordering to determine its watt rating/class of coil insulation.

Red-Hat II Solenoid Options

Using Table 3, find the desired solenoid option in the left column and the watt rating/class of coil insulation in the next column. The choice of prefixes is shown in the next two columns on that line. The first column indicates the prefix if Class F temperature protection is sufficient for your requirements. The second column provides the desired solenoid option, plus the higher temperature protection of a Class H coil.

For example, to select an 8262G2 valve with a Class H Open Frame Spade Terminal Solenoid, assuming the voltage to be 120 volts AC, 60 Hz:



- In the Specification Table for Series 8262, the Watt Rating/Class of Coil Insulation is 6.1/F for Catalog Number 8262G2.
- Using Table 3, find the listing for “Open Frame Solenoid with Spade Terminal Coil” in the left column. Then, find 6.1/F under AC coils in the next column. Reading across the column headed “Class H Coil,” you’ll find the prefix “OFST.” To order, specify Catalog Number OFST8262G2, 120/60.



(Note: Always include the voltage and frequency.)



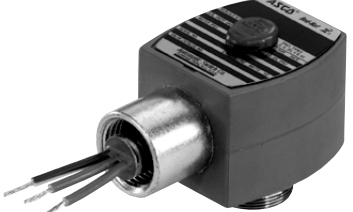

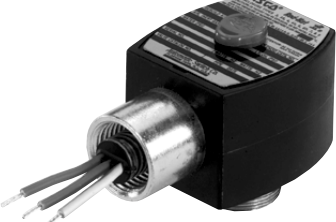
Table 3: Solenoid Options for Red-Hat II® Valves

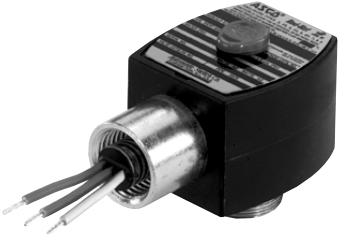
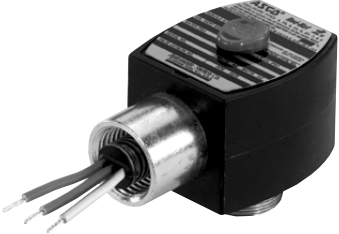

Solenoid Option Required	Watt Rating/Class of Insulation		Class F Coil Prefix	Class H Coil Prefix
	AC	DC		
General Purpose Solenoid (Standard Valve Construction)	6.1/F 10.1/F	1.4/F 10.6/F 11.6/F	—	— HT HT
	9.1/F 17.1/F	22.6/F	—	HB
Panel Mount Type 1 General Purpose Solenoid	6.1/F 10.1/F	10.6/F 11.6/F	GP	GPHT
	9.1/F 17.1/F	22.6/F	GP	GPHB
Type 7 Explosionproof Solenoid	6.1/F 10.1/F	10.6/F 11.6/F	EF	EFHT
	9.1/F 17.1/F	22.6/F	EF	EFHB
	10.1/F 15.1/F 17.1/F	1.4/F 11.6/F 22.6/F	EV	— EVHT EVHB
Open Frame Solenoid with Spade Terminal Coil	6.1/F 10.1/F	10.6/F 11.6/F	OFSF	OFST
	9.1/F 17.1/F	22.6/F	OFSP	OFSS
Panel Mount Solenoid with Spade Terminal Coil	6.1/F 10.1/F	10.6/F 11.6/F	OPSF	OPST
	9.1/F 17.1/F	22.6/F	OPSP	OPSS
Open Frame Solenoid with Screw Terminal Coil	6.1/F 10.1/F	10.6/F 11.6/F	OFKF	OFKH
	9.1/F 17.1/F	22.6/F	OFKP	OFKB
Panel Mount Solenoid with Screw Terminal Coil	6.1/F 10.1/F	10.6/F 11.6/F	OPKF	OPKH
	9.1/F 17.1/F	22.6/F	OPKP	OPKH
Junction Box with Spade Terminal Coil	6.1/F 10.1/F	10.6/F 11.6/F	JSF	JST
	9.1/F 17.1/F	22.6/F	JSP	JSS
Panel Mount Junction Box with Spade Terminal Coil	6.1/F 10.1/F	10.6/F 11.6/F	JPSF	JPST
	9.1/F 17.1/F	22.6/F	JPSP	JPSS
Junction Box with Screw Terminal Coil	6.1/F 10.1/F	10.6/F 11.6/F	JKF	JKH
	9.1/F 17.1/F	22.6/F	JKP	JKB
Panel Mount Junction Box with Screw Terminal Coil	6.1/F 10.1/F	10.6/F 11.6/F	JPKF	JPKH
	9.1/F 17.1/F	22.6/F	JPKP	JPKB
DIN Connection Solenoid	6.1/F 10.1/F	10.6/F 11.6/F	SC	SU
	9.1/F 17.1/F	22.6/F	SD	SV
Panel Mount DIN Connection Solenoid	6.1/F 10.1/F	10.6/F 11.6/F	OPSC	OPSU
	9.1/F 17.1/F	22.6/F	OPSD	OPSV

Important Note: One-piece molded epoxy Red-Hat II® solenoids are a unique combination of coil and enclosure. When ordering some Red-Hat II options, it may be necessary to specify the appropriate catalog number prefixes for both the enclosure and the coil.

<p>Type 1 General Purpose Solenoids with Class F High-Temperature Coils</p>	<p>Enclosures:</p> <ul style="list-style-type: none"> • Also meet Type 2 Dripproof, Types 3 and 3S Raintight, and Types 4 and 4X Watertight requirements. • Supplied standard with 1/2" threaded conduit hub and built-in strain relief for leads. <p>Coils:</p> <ul style="list-style-type: none"> • Insulation system for coil temperatures up to 311°F (155°C).^① • For ambient temperature requirement, refer to specific Series and charts in Engineering Information Section, beginning on page 11.00. • Suitable for 50 and 60 Hz.^② 	<p>Ordering Information: Supplied standard on all Red-Hat II valves.</p>	
<p>Type 1 General Purpose Solenoids with Class H High-Temperature Coils</p>	<p>Enclosures:</p> <ul style="list-style-type: none"> • Same as Class F. <p>Coils:</p> <ul style="list-style-type: none"> • Insulation system suitable for coil temperatures up to 356°F (180°C).^① • For ambient temperature requirements, refer to specific Series and charts in Engineering Information Section, page 11.00. • Suitable for 50 and 60 Hz.^② 	<p>Ordering Information: Depending on wattage, use catalog number prefix "HT" or "HB" (e.g., HT8210G2).</p>	
<p>Panel Mount Type 1 General Purpose Solenoids with Class F or H High-Temperature Coils</p>	<p>Enclosures:</p> <ul style="list-style-type: none"> • Same as above, but with provision for mounting on a panel (panel not included). <p>Coils:</p> <ul style="list-style-type: none"> • Same as Class F or H above. 	<p>Ordering Information: For Class F coil, use catalog number prefix "GP" (e.g., GP8210G2) and specify voltage. For Class H coil, depending on wattage, use catalog number prefix "GPHT" or "GPHB" (e.g., GPHT8210G2) and specify voltage.</p>	
<p>Type 7 (A, B, C, and D) Explosionproof Solenoids with Class F High-Temperature Coils</p>	<p>Enclosures:</p> <ul style="list-style-type: none"> • Also meets Types 3 and 3S Raintight, Types 4 and 4X Watertight, Types 6 and 6P Submersible, and Type 9 (E, F, and G) Dust Ignitionproof requirements. Refer to Engineering Information Section, beginning on page 11.00 for details. <p>Coils:</p> <ul style="list-style-type: none"> • Insulation systems suitable for coil temperatures up to 311°F (155°C) ^① • For ambient temperature requirements, refer to specific Series charts in Engineering Section, page 11.00. • Suitable for 50 and 60 Hz. ^② 	<p>Approvals: UL listed; CSA certified.</p> <p>Ordering Information: Use catalog number prefix "EF" (e.g., EF8210G2) and specify voltage.</p>	
<p>Notes: ^① UL limitations are 284°F (140°C) for Class F insulation systems and 320°F (160°C) for Class H insulation systems. ^② Can be supplied for 50 Hz at a reduced voltage, which is standard throughout the world; i.e., 120/60, 110/50.</p>			

<p>Type 7 (A, B, C, and D) Explosionproof Solenoids with Class H High-Temperature Coils</p>	<p>Enclosure:</p> <ul style="list-style-type: none"> • Same as Class F Explosionproof Coil: Insulation system suitable for coil temperatures up to 356°F (180°C).^① For ambient temperature requirements, refer to specific Series and charts in Engineering Information Section, beginning on page 11.00 • Suitable for 50 and 60 Hz.^② 	<p>Approvals: UL listed; CSA certified.</p> <p>Ordering Information: Depending on wattage, use catalog number prefix “EFHT” or “EFHB” (e.g., EFHT8210G2) and specify voltage.</p>	
<p>Type 7 (A, B, C, and D) Explosionproof Solenoids with Class F or H High-Temperature Coils</p>	<p>Enclosure:</p> <ul style="list-style-type: none"> • Same as above, but with 316 stainless steel conduit hub and stainless steel base plate. <p>Coils:</p> <ul style="list-style-type: none"> • Same as Class F or H Coil. 	<p>Ordering Information: For Class F Coil, use catalog number prefix “EV” (e.g., EV8262G220) and specify voltage. For Class H coil, depending on wattage, use catalog number prefix “EVHT” or “EVHB” (e.g., EVHT8327G2) and specify voltage.</p>	
<p>Type 7 (A, B, C, and D) Low Power Solenoids with Class F DC Surge Suppression Coils</p>	<p>Enclosure:</p> <ul style="list-style-type: none"> • Same as Class F Explosionproof coil. <p>Coils:</p> <ul style="list-style-type: none"> • Built-in surge suppression diodes. • Low power – 1.7 Watts. • Class F insulation only. 	<p>Ordering Information: Fo Surge Suppression coils, use catalog number prefix “EDMD” or “EVMF” (e.g., EFMF8314G300), and specify voltage.</p> <p>Note: Surge Suppression coils are only available for Explosionproof Low Power coils.</p>	
<p>Open Frame Solenoids with Class F or H High-Temperature Spade Terminal Coils</p>	<ul style="list-style-type: none"> • Valves with Open Frame solenoid construction are intended for use when a solenoid enclosure is not needed; e.g., mounting in a control cabinet. • Same as Class F or H above, but with 1/4" spade terminals. • Suitable for 50 and 60 Hz. ^② 	<p>Ordering Information: For Class F coil, depending on wattage, use catalog number prefix “OFSF” or “OFSP” (e.g., OFSF8210G2) and specify voltage. For Class H coil, depending on wattage, use catalog number prefix “OFSS” or “OFST” (e.g., OFST8210G2) and specify voltage.</p> <p>Note: Spade Terminal Coils are not available above 250 volts AC or DC.</p>	
<p>Panel Mount Solenoids with Class F or H High-Temperature Spade Terminal Coils</p>	<p>Same as above, but with provision for mounting on a panel (panel not included).</p>	<p>Ordering Information: For Class F coil, use catalog number prefix “OPSF” or “OPSP” (e.g., OPSF8210G2) and specify voltage. For Class H coil, depending on wattage, use catalog number prefix “OPSS” or “OPST” (e.g., OPST8210G2) and specify voltage.</p> <p>Note: Spade Terminal Coils are not available above 250 volts AC or DC.</p>	
<p>Notes: ^① UL limitations are 284°F (140°C) for Class F insulation systems and 320°F (160°C) for Class H insulation systems. ^② Can be supplied for 50 Hz at a reduced voltage, which is standard throughout the world; i.e., 120/60, 110/50.</p>			

<p>Open Frame Solenoids with Class F or H High-Temperature Screw Terminal Coils</p>	<ul style="list-style-type: none"> Valves with Open Frame solenoid construction are intended for use when a solenoid enclosure is not needed; e.g., mounting in a control cabinet. Same as Class F or H above, but with #8 screws terminals. Suitable for 50 and 60 Hz.② 	<p>Ordering Information: For Class F coil, depending on wattage, use catalog number prefix "OFKF" or "OFKP" (e.g., OFKF8210G2) and specify voltage. For Class H coil, depending on wattage, use catalog number prefix "OFKH" or "OFKB" (e.g., OFKH8210G2) and specify voltage.</p> <p>Note: Screw Terminal Coils are not available above 250 volts AC or DC.</p>	
<p>Panel Mount Solenoids with Class F or H High-Temperature Screw Terminal Coils</p>	<p>Coils:</p> <ul style="list-style-type: none"> Same as above, but with provision for mounting on a panel (panel not included). 	<p>Ordering Information: For Class F coil, depending on wattage, use catalog number prefix "OPKF" or "OPKP" (e.g., OPKP8210G2) and specify voltage. For Class H coil, depending on wattage, use catalog number prefix "OPKH" or "OPKB" (e.g., OPKH8210G2) and specify voltage.</p> <p>Note: Screw Terminal Coils are not available above 250 volts AC or DC.</p>	
<p>Junction Box Solenoids with Class F or H High-Temperature Spade or Screw Terminal Coils</p>	<ul style="list-style-type: none"> Enclosures meet Type 1 General Purpose, Type 2 Dripproof, Types 3 and 3S Raintight, and Types 4 and 4X Watertight requirements. Supplied standard with 1/2" threaded conduit hub and grounding provision. Must be ordered with spade or screw terminals. 	<p>Ordering Information: For Class F coil, depending on wattage, use catalog number prefix "JSF," "JSP," "JKF," or "JKB" (e.g., JSF8210G2) and specify voltage. For Class H coil, depending on wattage, use catalog number prefix "JSS," "JST," "JKH," or "JKB" (e.g., JKH8210G2) and specify voltage.</p> <p>Note: Junction Box Options are not available above 250 volts AC or DC.</p>	
<p>Class F General Purpose Only with Quick Disconnect Pin Connectors</p>	<ul style="list-style-type: none"> Available for wattages 10.1, 17.1, 11.6, and 22.6. Materials: aluminum, stainless steel and non-metallic, 3 & 4 pin in popular sizes. 	<p>Ordering Information: For Class F coil, depending on wattage, use catalog number prefix "VT" or "VB" and specify voltage.</p>	
<p>Notes: ① UL limitations are 284°F (140°C) for Class F insulation systems and 320°F (160°C) for Class H insulation systems. ② Can be supplied for 50 Hz at a reduced voltage, which is standard throughout the world; i.e., 120/60, 110/50.</p>			

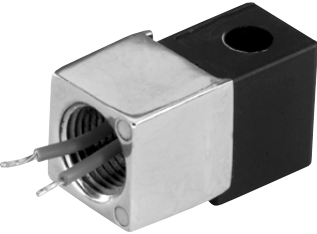
<p>Class F or H High-Temperature Coils with DIN Connections</p>	<ul style="list-style-type: none"> • Meets ISO 4400/DIN 43650 requirements. • Class F insulation system suitable for coil temperatures up to 311°F (155°C).^① <i>For ambient temperature requirements, refer to specific Series and charts in Engineering Information Section, beginning on page 11.00.</i> • Class H insulation system suitable for coil temperatures up to 356°F (180°C).^① <i>For ambient temperature requirements, refer to specific Series and charts in Engineering Information Section, beginning on page 11.00.</i> • Enclosure protection with DIN connector equivalent to Types 1 and 4. • Suitable for 50 and 60 Hz.^② 	<p>Ordering Information: For Class F Coil, depending on wattage, use catalog number prefix "SC" or "SD" (e.g., SC8210G2) and specify voltage.</p> <p>For Class H coil, depending on wattage, use catalog number prefix "SU" or "SV" (e.g., SU8210G2) and specify voltage.</p> <p>Note: Optional DIN-type strain-relief connector kit includes a gasket and mounting screw. Outlet accommodates cable with O.D. of 0.310" to 0.400".</p> <p>Note: DIN Connection Coils are not available above 250 volts AC or DC.</p> <p>Must be ordered separately as Kit No. K236034.</p>	
<p>Junction Box for Class F or H Coils</p>	<p>Junction box (shown installed on Red-Hat II solenoid) is a zinc coated steel housing with two 7/8" knock-outs for through wiring. UL listed when ordered factory assembled. Also available, without UL listing, as a kit with grounding screw for field installation.</p>	<p>Ordering Information: For factory assembly, add prefix "JB" to Valve Catalog Number. For kit, use number K272140.</p>	
<p>Sub-Miniature Coils for Series 8225, 8325, 8280, 8380, 8401, and 8551 Class F High-Temperature Molded Coils with DIN Connection</p>	<p>These sub-miniature coils meet 3 x DIN 46244 requirements.</p> <ul style="list-style-type: none"> • Insulation system suitable for coil temperatures up to 311°F (155°C).^① <i>For ambient temperature requirements, refer to specific Series and charts in Engineering Information Section, beginning on page 11.00.</i> • Suitable for 50 and 60 Hz.^② • "Enclosure Protection" with DIN connector equivalent to Types 1 and 4. 	<p>Ordering Information: Use catalog prefix "SC" (e.g., SC8225A1V) and specify voltage.</p> <p>Note: Optional DIN-type strain-relief connector kit includes a gasket and mounting screw. Outlet accommodates cables with O.D. of 0.310" to 0.400". Must be ordered separately as Kit No. K226061-1.</p>	
<p>1/2" Threaded Conduit Hubs</p>	<p>These conventional threaded hubs allow connection with 1/2" BX cable. Can be supplied with leaded coil only. Kit includes gasket and attaching screw.</p>	<p>Ordering Information: Order separate Kit No. K224735.</p>	
<p>Notes: ^① UL limitations are 284°F (140°C) for Class F insulation systems and 320°F (160°C) for Class H insulation systems. ^② Can be supplied for 50 Hz at a reduced voltage, which is standard throughout the world; i.e., 120/60, 110/50.</p>			

Optional Construction Features

Standard valve construction materials for standard valves are shown on the Series pages. If handling fluids other than those listed in the Specifications section, you may require special constructions, however. The most frequently used elastomers are listed in Table 4 along with the Valve Series in which they are available. Other considerations for a variety of liquids and gases are included in the Valve Material Selection Guide, which starts on page 11.20. A solenoid valve must use certain construction material for proper electrical function. *If you cannot find the specific fluid in the guide, please consult your local ASCO office.*

Certain fluids may also require that we change the solenoid shading coil. The standard valves use a copper shading coil. Aluminum and silver are also available and, due to their different magnetic properties, additional electrical changes may be necessary. *When a change in shading coil material is indicated in the guide, please consult your local ASCO office.*

Table 4: Optional Construction Features for ASCO Solenoid Valves Handling Liquids and Gases other than Air, Inert Gas, Water, and Light Oil. Orders entered using this table MUST state actual fluid and pressure of application.

Pipe Size (ins.)	Series Number or Valve Type	Valve Construction Number	Special Construction Features ③ ELASTOMERS				
			EPDM	Oxygen Service	PTFE	FKM	CR
			Use Suffix "E"	Use Suffix "N" ①	Use Suffix "T" ②	Use Suffix "V"	Use Suffix "J"
SOLENOID OPERATED VALVES							
3/8 - 3/4	8030, 8040	1-10, 13	Available on all constructions	Available on all constructions	Not Available	Available	Available on all constructions
3/8 - 1 1/2	8210	1, 2, 5, 6, 7, 8, 9, 11, 12, 16, 18, 23, 24, 25, 26, 28, 29, 31-51			Not Available	Available	
3/4 - 2 1/2	8210	10, 20, 21, 27, 30			Available	Available	
3/8 - 3	8215	All			Not Available	Available	
All	8260	1, 2, 3			Not Available	Available	
All	8260	4, 5, 6			Not Available	Not Available	
1/8 - 3/8	8262, 8263	1 - 7, 11, 12, 13, 16, 17			Available	Available	
1/8 & 1/4	8262	8, 9, 14			Available	Available	
3/8 & 1/2	8316	1, 2			Not Available	Available	
3/4 & 1	8316	3, 4, 5			Not Available	Available	
All	8320, 8360	All			Available	Available	
AIR OPERATED VALVES							
1/4	2 Ports	1, 2, 22	Available on all constructions	Available on all constructions	Available	Available	Available on all constructions
3/8 - 3/4	2 Ports	8			Not Available	Available	
3/8 - 3/4	2 Ports	3, 4			Not Available	Not Available	
3/8 - 3/4	2 Ports	6, 7, 16, 17			Not Available	Available	
1 & 1 1/4	2 Ports	10, 12, 18, 19			Not Available	Available	
1 1/2	2 Ports	14, 20			Not Available	Available	
1/4	3 Ports	1			Available	Available	
3/8 & 1/2	3 Ports	2			Not Available	Available	
3/4 & 1	3 Ports	3, 4			Not Available	Not Available	

Notes: ① For valves requiring special cleaning and/or testing procedures, such as for oxygen, freon, & sanitary service, refer to Table 6.
 ② Pressure ratings must be reduced by 25%.
 ③ Unless otherwise indicated in the Series Specification Tables, all soft seating valves are supplied with NBR discs, diaphragms, or gaskets.

Manual Operators

Manual operators are provided to operate the valve manually when electric power is off. There are basically two types of manual operators: momentary and maintained. Series 8320, 8321, and 8342 can be fitted with either type.

To determine which type is available for your valves, check the Construction Reference Numbers in their Series Specification Tables against the Table below. Schematics of the manual operators and how they are fitted to the valves are shown on the right. *If no manual operator is listed or a different type is required, consult your local ASCO office. Add suffix "MO" or "MS" to the catalog number.*

Table 5: Manual Operators

MANUAL OPERATORS ④ FOR 2 WAY SOLENOID VALVES						
Series Number	Pipe Size (ins.)	Valve Construction Reference Number	Valve Body Materials	Manual Operator Suffix	Type of Manual Operator	Illustration Number
8030	3/8, 1/2	1, 2, 3, 11	Brass	MO	Maintained	5
8030	3/4	9	Brass	MO	Maintained	3
8030	3/8, 1/2	1, 2, 3, 11	Stainless Steel	MO	Maintained	5
8030	3/4	10	Stainless Steel	MO	Maintained	3
8210	3/8, 1/2	1, 2	Stainless Steel	MO	Maintained	5
8210	3/8, 1/2	1, 2	Brass	MO	Maintained	5
8210	3/8 to 2 1/2	3, 5, 6, 8, 9, 11, 12, 16, 18, 20, 21	Brass	MO	Maintained	2
8210	3/4 to 1 1/2	10, 31, 32, 33	Brass	MO	Maintained	3
8210	1	42	Brass	MO	Maintained	4
8210	3/4	7	Stainless Steel	MO	Maintained	2
8221	3/8 to 3/4	1, 2, 5, 6, 7, 11, 12	Brass	MO	Maintained	2
8262	1/8	1	Brass	MO	Maintained	3
8262	1/8	1	Stainless Steel	MO	Maintained	3
8262	1/8	8	Brass	MS MO	Maintained Momentary	3 1
8262	1/8	8	Stainless Steel	MS MO	Maintained Momentary	3 1
8262	1/4	2, 4, 6, 16, 17	Brass	MO	Maintained	2
8262	1/4	11, 12, 13	Stainless Steel	MO ⑥	Maintained	2
8263	3/8	3, 5, 7	Brass	MO	Maintained	2
MANUAL OPERATORS ④ FOR 3 WAY SOLENOID VALVES						
8300	All	All	Brass	MO	Maintained	4
8300	All	All	Stainless Steel	MO	Maintained	4
8316	All	All	Brass	MO	Maintained	2
8320	1/8, 1/4	All	Brass Stainless Steel	MS ⑤ MO ①	Maintained Momentary	3 1
8321	All	All	Brass	MS MO	Maintained Momentary	3 1
MANUAL OPERATORS ④ FOR 4 WAY SOLENOID VALVES						
8340	1/4	8340A1, A3, A4	Aluminum	MO	Momentary	1
8342	1/4, 3/8	Single Solenoid Only	Brass Stainless Steel	MS MO	Maintained Momentary	4 1
8344 ③	All	All	Brass	MO	Maintained	2
8345	1/4	1	Brass	MO	Maintained	5
8401	1/8, 1/4	All	Aluminum	②	Momentary Maintained	— —
MANUAL OPERATORS ARE ALSO AVAILABLE FOR ALL LOW POWER AND INTRINSICALLY SAFE VALVES (MANUAL OR MOMENTARY). USE SUFFIX "MO."						
Notes: ① Limited to 100 psi (7 bar) maximum on Normally Open and Universal operation. ② Supplied as standard, no suffix required. ③ Two manual operators required for Dual Solenoid construction. ④ Limited to 250 psi (17 bar) pressure, except where noted otherwise. ⑤ Valves with MS suffix maintain full catalog ratings. ⑥ Manual operator not available for this series with steam application.						

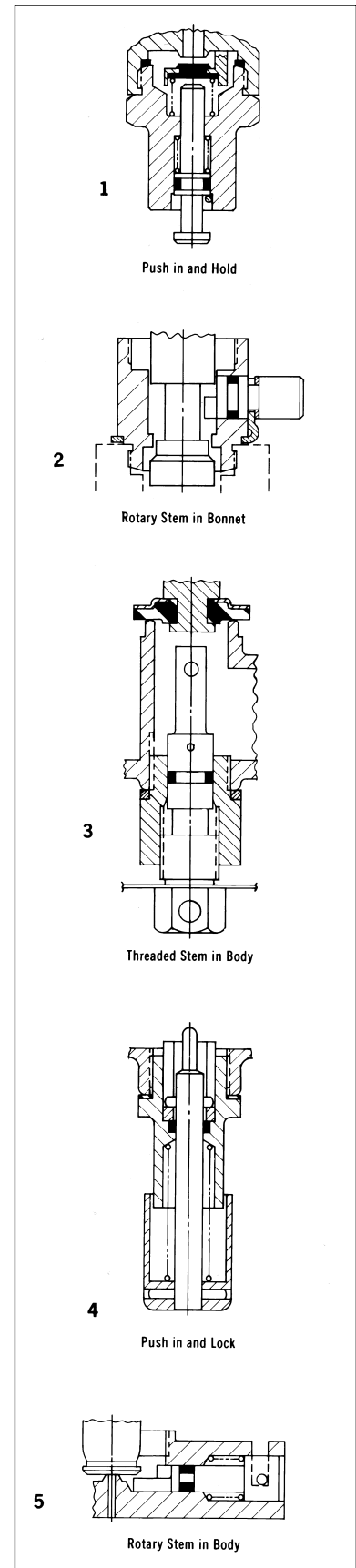

Metering Devices

Metering Devices are used for obtaining an exact flow from solenoid valves for dispensing or for moving an air operator in a given time period. Valves which can be fitted with metering devices are Series 8262 (1/8" NPT size only), 8260, 8401, 8402, and 8342. Add suffix "M" to catalog numbers.

Special Cleaning and Testing Procedures:

If special cleaning and testing procedures are required, they must be specified when ordered. *These procedures cannot be done after the valve is built.*

Table 6: ASCO Special Cleaning and Testing Procedures

Fluid	Description of Cleaning or Testing Procedure	Order by Specifying
Freon	All valve parts inspected for oil, grease, metal dust, and other foreign matter and degreased, if necessary. Assembled in clean, dry area and helium mass spectrometer tested for external leakage. Pipe connections sealed with plugs.	Clean and test per ASCO AP-1-005 Procedure.
Oxygen	All valve parts degreased and blacklight inspected for cleanliness. Assembled and tested in clean area using oil-free air or nitrogen. Helium mass spectrometer tested for external leakage. Pipe connections sealed with plugs. Each valve tagged covering certification of tests and put in a sealed bag.	Clean and test per ASCO AP-1-004 Procedure. Add Suffix "N" to catalog Number.
Sanitary distilled water and other clean systems	All valve parts inspected for oil, grease, metal dust, and other foreign matter and degreased, if necessary. Valves assembled in clean area and tested with clean, dry air or nitrogen. Pipe connections sealed with plugs.	Clean and test per ASCO AP-1-008 Procedure.