



Original

Installation and service instruction

Knife gate valves

Table of contents



A)	General	2
A1	Symbols	2
A2	Valve destination.....	2
A3	Related documents	2
A4	Valve marking	3
A5	Transport, storage and handling.....	3
	Storage and transport:	3
	Handling:.....	3
B)	Installation/functional check	4
B1	Safety warnings at installation.....	4
B2	Conditions for installation	4
B3	Pressure, flow direction and valve position	5
B4	Necessary support for special cases.....	5
B5	Steps to install.....	5
B6	Installation in an ATEX-classified area 	7
B7	Pressure testing after installation (if necessary).....	8
B8	Disassembling the valve	8
C)	Service and maintenance	9
C1	Safety warnings at service and maintenance	9
C2	Manual and automatic actuation	10
C3	Maintenance.....	10
C4	Troubleshooting	10
	Declaration in compliance with EU-Directives	11

A) General

In this instruction a “knife gate valve” is shortly called “valve”.

A1 Symbols

In this instruction notes and warnings are marked with symbols:

 XXXXXX	Danger / Warning Points out a dangerous situation which may cause personal injuries or death.
	Advice Has to be respected.
	Information Information useful to follow.

If these notes and warnings are not respected by the user, dangerous situations may occur and may invalidate the warranty of the manufacturer.

A2 Valve destination

Valve types **BV, D2G, HG, HL, HP, JTV, MP, MV, RKO, RKS, SLF, SLV, SLH, SLX, TV, XV** and **WB** are destined – after installation between flange(s) in a pipe system – to shut off, to open or to control the flow within the admissible pressure/temperature limits.

These pressure and temperature limits depend on the materials of valve body, gate and seat. Temperature limits are defined in the valve data sheet of each type. Maximum working pressure are marked at the valve body and on the label attached on the beam.

The flow shall be without vibrations and/or pressure chocks. The surrounding environment should not imply any risk to the valve. This also implies to explosive environment – except for valves classified for ATEX- area  and marked accordingly.

Installation of the knife gate valve is preferred with the actuator in an upward position – except for RKO, JTV and D2G.

At valve operation respect:

- The manufacturers declaration to EC directives,
- This original installation and service instruction which is supplied together with the valve.

Stafsjö Valves AB does not accept any responsibility if this “Valve destination” is not observed.

A3 Related documents

Further information on the valves is available on www.stafsjo.com.

ds+valve type (i.e. *ds-BV*) = Data sheet with technical information (dimensions, material specification etc.)

mi+valve type (i.e. *mi-BV*) = Instructions for maintenance on each valve type.



sp+valve type (i.e. *sp-BV*) = Specify spare parts for each valve type.

acc+type of accessory (i.e. *acc-SV*) = Accessory for different types of valves. I.e solenoid valve.



stafsjo-valve-spec = Specification of parts and valve combinations.

A4 Valve marking

Each valve is labelled as follows:

 <p>Art.No. MVL020F50P00</p> <p>Ser.No. 2010-195113-59666</p> <p>Max PS Valve body/differential: 10/10 BAR</p>	 <table border="1" style="width: 100%; border-collapse: collapse; margin-top: 10px;"> <thead> <tr> <th>Säte/Seat/Dichtung</th> <th>Blad/Gate/Platte</th> </tr> </thead> <tbody> <tr> <td>PTFE</td> <td>1.4301</td> </tr> <tr> <td>PU</td> <td>1.4401</td> </tr> <tr> <td>EPDM</td> <td>1.4162</td> </tr> <tr> <td>NBR</td> <td>1.4462</td> </tr> <tr> <td>Viton</td> <td>HCR</td> </tr> <tr> <td>Other</td> <td>Other</td> </tr> </tbody> </table>	Säte/Seat/Dichtung	Blad/Gate/Platte	PTFE	1.4301	PU	1.4401	EPDM	1.4162	NBR	1.4462	Viton	HCR	Other	Other	<p>Additional: Markings on casted valve body:</p> <p>DN XXXX: (mm) nominal diameter PN XX: (bar) pressure class of valve body i.e. GGG50 valve body material</p>
Säte/Seat/Dichtung	Blad/Gate/Platte															
PTFE	1.4301															
PU	1.4401															
EPDM	1.4162															
NBR	1.4462															
Viton	HCR															
Other	Other															
<p>Ser.No: Serial number consisting of year – individual no - order number. CE-marking when applicable.</p> <p style="text-align: center;">Label for identification of seat and gate material</p>																

These labels shall not be removed, over coated or otherwise covered.

	<p>“Max. PS Valve body” which is marked on the label (see above) is max. allowed pressure when the valve is open. Max. allowed pressure on closed valves may be lower and is marked on this label as well. More information on this is available in the data sheet which can be downloaded from www.stafsjo.com.</p>
	<p>Refer to the “Serial Number” of the valve marking at any contact with Stafsjö.</p>

A5 Transport, storage and handling

Note

Additional requirements may be found in the actuator instruction, if any.

Storage and transport:

Keep the valve in open position during storage to ensure its function and to protect the polished surface of the gate. Store the valve in a clean and dry environment and protect it against dirt, dust and other contamination. Do not expose the valve to direct sunlight. If the valve is stored outside, it shall be wrapped tightly in a plastic foil or similar to protect it against moisture or any dirt contamination. It should also be stored high enough without any risk to be covered in snow or enclosed by water.

	<p>The valve has been packed according to the terms of delivery. It is important to make a visual inspection at arrival. If transport damage is detected, report to the transportation company.</p>
---	---

Handling:

Lifting and moving shall be carried out with soft straps. Place and fasten the soft strap on the valve body as shown in fig.1. Make shure that all equipment is designed to hold the weight of the valve.

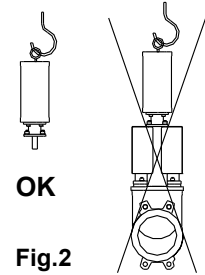

Fig.1

	<p>Never place lifting equipment:</p> <ul style="list-style-type: none"> • On the actuator, accessories or gate guards. • In the bore of the knife gate valve, since it cause damages to the seat and retainer ring.
---	--

**Original installation and service instruction
Knife gate valves**



	Specifically note that threaded hole on top of pneumatic cylinder type EC, is only for handling the cylinder itself. See figure 2.
---	--



B) Installation/functional check

	This instruction includes safety recommendations for foreseeable risks at installation into a (pipe) system. The user is responsible to complete this instruction with warning notes for system-specific aspects. All requirements of the system shall be observed.
---	---

B1 Safety warnings at installation

	<ul style="list-style-type: none"> • Installation shall be performed by qualified personal. Qualified are those persons who, due to experience, can judge the risks and execute the work correctly and who are able to detect and eliminate possible risks. • After installation, the function of the valve shall be in accordance with the valve and the actuator (if any) destinations, see section A2. • At the end of the installation the gland bolting shall be tightened according to Table in section B7. • A valve without an actuator should not be installed into the (pipe) system. • Some valve types can be installed as end valves. Contact Stafsjö for specific requirements and information.
 Danger	<ol style="list-style-type: none"> 1. A valve with an actuator shall only be operated if: <ul style="list-style-type: none"> • The valve is installed between flanges or between a flange and a protective device. • The gate guards are installed on the beams on automatic operated valves. 2. If the knife gate valve is installed as an end valve in a pipe line, always install protective equipment to prevent people getting to close to the valve and being exposed to the media transported in the system when the valve opens. <p>People's life and health is at stake if this is not observed. Any other action is the responsibility of the user.</p>

B2 Conditions for installation

Make sure:

- To install valves according “Valve destination”, see section A2. Observe valve marking, see section A4.
- That the pipe section is not exposed to vibrations or other mechanical stresses which could deform the valve body and affect the valve's tightness and/or ability to operate.
- That the valve environment does not imply any risk to the valve, the actuator or the accessories. This also implies to explosive environment – except for valves classified for ATEX- area Ⓜ and marked accordingly.
- That flanges, pipe line and the valve are empty, free from solid and sharp particles.
- That the valve is installed between flange(s) (fixed or loose) to ensure that the valve is securely fixed and that the flange keeps tight.
- That the knife gate valve is protected against radiant heat, if the valve is placed near a heat source whose temperature exceed maximum allowable temperature for the valve or its actuator.
- The mating (=gasket contact) surface of the flange cover the retainer ring completely. Detailed information on flange drilling, threads, length and number of bolts is available in data sheet on www.stafsjo.com.
- To follow those instructions which are supplied with an actuator (if any).
- The pipe line is free from pressure.
- Additional requirements may be found in the actuator instruction – specifically to adjust the correct OPEN and CLOSED positions before the valve is installed.

Original installation and service instruction

Knife gate valves

B3 Pressure, flow direction and valve position

When the knife gate valve is open, $P_1=P_2$, the pipe line pressure may not exceed maximum allowable working pressure body according to each valve. When the valve is closed, the differential pressure ΔP , is the difference between P_1 and P_2 ($\Delta P = \pm (P_1-P_2)$).

The differential pressure ΔP may not exceed maximum allowable differential pressure according to each valve. Maximum allowable differential pressure for closed valve is available in data sheets.

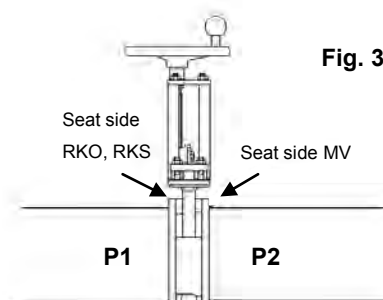

- Valves types **XV, HL, HG, HP, BV, WB, D2G, SLV, SLF, SLH and SLX** are bi-directional and can therefore be installed independent of the pressure ratio in any direction in the pipe line.
 - **Valid for MP only:**
This valve type is bi-directional but have a preferred pressure direction. The preferred direction is achieved when the SEAT SIDE is installed as the valve outlet (towards P2) provided that $P_1 > P_2$.
 - **Valid for MV only:**
This valve type has different differential pressure ΔP capacities in the flow directions. The maximum ΔP capacity of the valve is achieved when the SEAT SIDE is installed as the valve outlet (towards P2) provided that $P_1 > P_2$. When the valve is closed, the pressure ratio shall be $P_1 > P_2$. Some sizes of MV equipped with specific seats are capable to handle certain differential pressure in reversed pressure direction. For further information, see data sheets on www.stafsjo.com.
 - **Valid for RKO and RKS only:** These valve types have different differential pressure ΔP capacities in the flow direction. The maximum ΔP capacity of the valve is achieved when the seat side is installed as the valve inlet (towards P1) provided that $P_1 > P_2$. When the valve is closed, the pressure ratio shall be $P_1 > P_2$.
 - **Valid for TV only:**
This valve shall be installed with the seat side to the tank. The removable retainer ring shall be mounted towards the tank which implies that changing of the seat can only be done when the tank is empty.
 - All valve types, except for valves **D2G, JTV, RKO and RKS** are preferred to be installed in a horizontal pipe (system) with the actuator in a vertical upright position.
- Valid for D2G, RKO, JTV and RKS only:**
These valve types are designed to be installed in a vertical pipe.

B4 Necessary support for special cases

The dead weight of a valve in large dimension together with its actuator may cause tensions/deformations in the valve that could affect the valve's function, specifically when it is installed at inclined positions or in a vertical pipe. In these cases, the valve and/or actuator shall be supported to avoid functional failure.

Valves that are exposed to vibrations or other mechanical stresses can be subject to forces that will affect valves tightness and ability to operate. In these cases, the valves and actuators shall be supported to avoid function failure. Support details are the responsibility of the customer. Stafsjö will assist on request.

B5 Steps to install

On handwheel operated valves, when the handwheel is not assembled at delivery, follow the steps below to assemble the handwheel to the valve.

**Original installation and service instruction
Knife gate valves**

Fig. 4 Assembling of handwheel

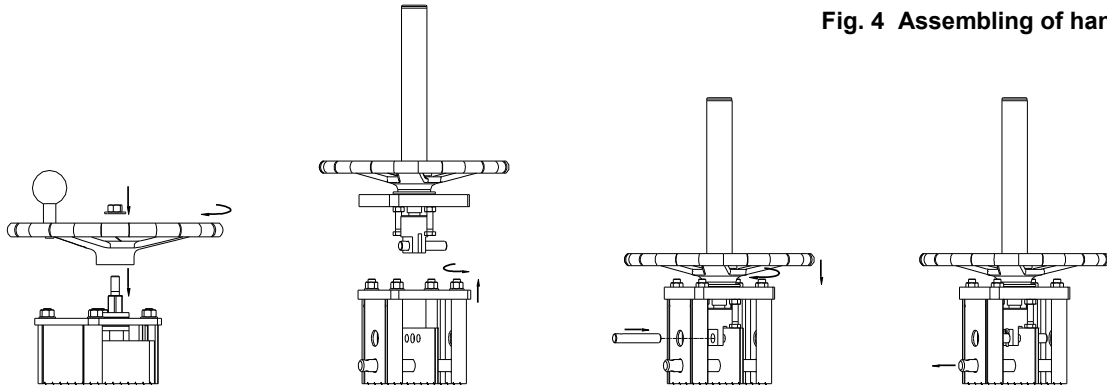

Handwheel with <u>non-rising</u> stem	Handwheel with <u>rising-stem</u>		
<p>1. Assemble the handwheel to the valve. Check that there is not any play between the actuator, bearing and yoke. If there is, eliminate the play by rotating the stem 360 degrees counter clockwise. Then fixate the handwheel with a locking nut.</p>	<p>1. Loosen the nuts from the tie rods and remove the tempo-rary yoke plate.</p>	<p>2. Assemble the handwheel unit to the tie rods and fixate it with washers and nuts. Attach the gate clevis to the gate and fixate with clevis pin and split pins.</p>	<p>3. Remove the safety pin. For safety reasons, the pin shall not be removed until the handwheel unit is assembled and the gate clevis is properly attached to the gate.</p>

When the handwheel is assembled, install the valve into the pipe (system).

When installing the valve, make sure that:

- The valve's centre line is on the same centre line as the flanged pipe's.
- Flange surfaces of the pipe and valve must be exactly parallel.

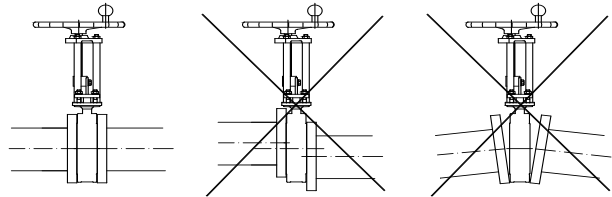

Fig. 5

If the flanges and the valve are not centred, the valve may be damaged by erosion and a dirt pocket may occur which can lead to clogging and corrosion of the valve.

	<ul style="list-style-type: none"> • Valve type RKO and XV must be installed in <u>closed</u> position only. • Valve type SLV, SLF, SLH and SLX must be installed in <u>open</u> position only! Also note that SLV's and SLF's, bottom cover is only allowed to be mounted on the valve when flushing is made through the purge ports in the valve body. Also note that SLH's and SLX's bottom ports are only to be closed when the valve is used on clean fluid.
--	---

1. Place the gaskets between the valve body and the flange. Check that the gasket is well centered and covers the complete surface of the retainer ring.

	<p>Valve types WB, SLV, SLF, SLH and SLX only: These valve types are equipped with integrated rubber flange gaskets – additional gaskets are not necessary.</p>
--	--

2. Lubricate the bolts. This allows correct pre-setting of the flange and makes it easier to dismantle the bolting later.

	<p>All Valve types: Flange bolts of right length are necessary:</p> <ul style="list-style-type: none"> • Too long bolts could deform the valve body and result in leakage in the flange. • Too short bolts could deform the threaded holes in the valve body at installation. <p>Choose bolts with the correct thread and length according to the flange drilling information in the data sheet.</p>
--	---

**Original installation and service instruction
Knife gate valves**

!	All Valve types of cast grey iron material (WB): Extra caution is necessary when installation due to the brittle material. Place the valve between flanges. First tighten the through going bolts so the flanges is close to the valve to not more than maximum torque as below. Then end by tighten the bolts for blind holes.					
	DN	350	400	450	500	600
	Nm	140	160	160	180	180
	Lbf.ft	103	118	118	132	132

- Tighten the bolts first manually and then evenly and crosswise, for a uniform load of the gasket, with a torque as required by the gasket manufacturer. Valve type **SLV, SLF, SLH and SLX** shall be assembled with the mating surfaces of the valve body and the pipe flanges up to metal/metal contact. See fig. 6.

!

Fig. 6

1=Wrong 2=Wrong 3=Correct

Make sure that the flange is centered and is covering the metal frame around the seat (picture 3).
Tighten flange bolts crosswise to eliminate any gap between body and flange.

Fig. 6

- To finish the installation, make an operational test by opening /closing the valve. Observe the actuator (if any) instructions.
 - A valve with handwheel should be operated with normal hand force. Exceptional force used to close the valve can damage it.
 - A valve with electric/pneumatic actuator shall be operated by the plant control signals into its end positions, i.e. OPENED and CLOSED.
 - At connection of an actuator to the plant control system the actuator,s instructions shall be followed.
- If the pipe line is to be cleaned by flushing in order to wash out impurities, the valve must be opened 100%.

i	<i>Valves with actuator supplied by Stafsjö are exactly adjusted in the end positions:</i> This adjustment shall not be changed as long as the valve operates correctly.
!	Only for Valves with electric actuator: Ensure that the actuator motor stops <u>by the signal of the limit switch for closed and open position of the actuator.</u> Exceptional force may damage the valve. The signal of the <u>torque switch</u> may be used for signal <u>for faulted conditions.</u> <i>For further information, see the actuator instruction.</i>

B6 Installation in an ATEX-classified area

Note:

*Additional requirements may be found in the actuator instruction, (if any).
This ATEX instruction is valid along other instructions in this document.*

**Original installation and service instruction
Knife gate valves**

	In ATEX-classified zones, in accordance with ATEX Directive 94/9/EC, only valves with ATEX-classification and the relevant valve marking shall be installed.
---	--



Additional to the requirements above make sure that:

- The valve is part of the plants earthed system.
- The user has performed a risk analysis of the pipe line and valve in accordance with the guidelines of ATEX Directive 94/9/EC.

B7 Pressure testing after installation (if necessary)

Each Valve has been tested before delivery by the manufacturer according to EN12266-1. For pressure test of the pipe section with a knife gate valve installed the conditions for the system apply but with the following restrictions:

- The pressure test **shall not exceed 1,5 x max. working pressure of the valve** (see valve marking). The gate shall be open.
- Pressure test with valve in closed position shall not be tested more than **1,1x max. differential pressure in preferred pressure direction**, (see datasheets) in order to prevent overload of the gate.

	<i>Immediately at this operation check the stuffing box tightness:</i> In case of leakage: Tighten the gland nuts evenly crosswise and bit by bit until leakage stop. Do not tighten more than necessary!				
	Recommended maximum torque				
	DN	DN 50 – DN 80	DN 100 – DN 150	DN 200 – DN 300	≥ DN 350
	Nm	20	25	30	35
	lbf x ft	15	18	22	26

B8 Disassembling the valve

Note:

Additional requirements may be found in the actuator (if any) instruction.

For the valve the same safety instructions apply as for the pipe (system) and for the control system to which the actuator (if any) is connected. The respect of these requirements shall be followed.

	Disassembling the valve from the pipe line may only be done when: <ul style="list-style-type: none"> • the pipe section is free from pressure and is empty • all the electronic and/or pneumatic/hydraulic connections have been disconnected People's life and health is at stake if this is not observed. Any other action is the responsibility of the user.
---	--

Disassemble the valve in following steps:

1. Depressurise the pipe section and drain it completely.
2. Disconnect all electric and/or pneumatic/hydraulic connections.
3. Fasten and use soft straps if necessary (see also Fig.1 in section A5). Make sure not to damage the valve, gate, gate guards or any accessory.
4. Take out the valve from the pipe carefully in order to protect the flange gaskets.
5. At transport and storage observe section A5.

C) Service and maintenance

Note

Additional requirements may be found in the actuator instruction.



The user shall make a risk analysis as per Machinery Directive 2006/42/EC for the pipe system. Stafsjö supplies the following documents for it:

- The original installation and service instruction of the valve.
- An installation and service instruction of the actuator (if any)
- The manufacturer's declaration(s) to EC Directives.

	This instruction includes safety notes for industrial application for any foreseeable risk at use of the valve. It is the responsibility of the user/planner to complete this instruction with warning notes for plantspecific risks.
---	---

Further information on Stafsjö's valves is available on www.stafsjo.com.

C1 Safety warnings at service and maintenance

	<ul style="list-style-type: none"> • At operation, the function of the valve shall be in compliance with the <Valve Destination>, see section A2. • The service conditions of the valve shall be in compliance with the valve markings, see section A4. • Service and maintenance shall be performed by qualified personal. Qualified are those persons who, due to experience, can judge the risk and execute the work correctly and who are able to detect and to eliminate possible risks. • At service the valve should be inspected periodically (preferably every day) for leakage or other external effects that could affect the safety for the personnel. • Valves, destined for use in a ATEX classified zone, must be marked according to the ATEX directive. • At any start up, the gland box shall be visually inspected for leakage. If any are detected, the nuts shall be tightened according to table in section B7. Except for this action, no maintenance is allowed on the valve when the pipe line is pressurised. • At maintenance or repair of an actuator, it shall be disconnected as described in section B8. The pipe section must be free from pressure and completely drained at both sides of the valve before any maintenance begins. • Some valve types can be installed as end valves. Contact Stafsjö for specific requirements and further information. • The temperature of the exterior parts of the valve depends of the fluid temperature inside – any protective insulation is in the responsibility of the user. • When bottom cover is installed on SLV and SLF, flushing is recommended through the purge ports after manouvering.
 Danger	<ol style="list-style-type: none"> 1. The gland box packing together with the gland makes sure that no media reaches surrounding environment where the gate exit the valve body. When the gland box packing (braids) shall be changed, the gland bolts must be loosened and the the pipe section shall be depressurised and empty. 2. A valve with an actuator shall be actuated only if: <ul style="list-style-type: none"> • The valve is installed between flanges or between a flange and a protective device. • The gate guards are installed on the beams, on automatic operated valves. 3. If you install the knife gate valve as an end valve in a pipe line, always install protective equipment to prevent people getting to close to the valve and being exposed to the media transported in the system when the valve opens. <p>People's life and health is at stake if this is not observed. Any other action is the responsibility of the user.</p>

**Original installation and service instruction
Knife gate valves**

C2 Manual and automatic actuation

A knife gate valve with handwheel closes clockwise.

A valve with automatic actuator is operated following the signals from the plant control system. Valves equipped with actuator supplied by Stafsjö are exactly adjusted to stop in the exact end positions. This adjustment shall not be changed as long as the valve operates correctly.

Valves with infrequent operation:

A test with full actuation movement should be performed once a month, to verify that the valve function correctly.

C3 Maintenance

As long as the valve is tight the only maintenance that has to be performed is a visual control of the stuffing box tightness. Tighten the gland at any leakage; see section B7 for recommended maximum torque.

C4 Troubleshooting

Problem	Reason	Measure
Leakage from stuffing box packing	Gland bolting too loose* Worn-out box packing Incorrectly installed box packing Damaged gate	See relevant maintenance instructions issued by Stafsjö <i>Download: www.stafsjo.com</i>
Leakage at flange connection	Wrong length of bolts in flanges Loose flange bolting Valve not centred at flange connection Valve not parallel to flanges Gasket not centred Wrong gasket material	See this instruction, section B7 See Stafsjö's maintenance instructions and relevant data sheet <i>Download: www.stafsjo.com</i>
Leakage through valve bore	Worn-out seat/sealing profile Valve does not close 100% Damaged seat or gate	See relevant maintenance instructions issued by Stafsjö <i>Download: www.stafsjo.com</i> See instruction for actuator (if any)
Gate does not open/close completely	Fault in actuator Fault in limit switch setting Valve clogged Damaged seat/sealing profile or gate	See instruction for actuator/accessories See the relevant maintenance instructions issued by Stafsjö <i>Download: www.stafsjo.com</i>
Gate does not open/close in a smooth movement	Fault in actuator Valve clogged Damaged seat/sealing profile or gate Not enough air supply pressure Not enough air flow supply	See the relevant instruction for actuator See relevant maintenance instructions issued by Stafsjö <i>Download: www.stafsjo.com</i>
Too large force to open/close the gate (too high hand force as well)	Gland nuts tightened by too high torque Valve exposed to stress/tension Valve clogged or deformed Damaged seat/gate	See the relevant maintenance instructions issued by Stafsjö <i>Download: www.stafsjo.com</i>

* *When tightening the gland box bolts: See Table section B7*

Stafsjö can offer maintenance of valves. Contact Stafsjö or your local representative for further information.

Stafsjö does not accept any responsibility for the product if wear parts not tested and approved by Stafsjö are used on the valve. Stafsjö does not accept any responsibility for the product if maintenance instructions are not followed during maintenance.

**Original installation and service instruction
Knife gate valves**

Declaration in compliance with EU-Directives

The manufacturer **Stafsjö Valves AB, SE-618 95 Stavsjö Sweden**, declares that valve types **BV, D2G, HG, HL, HP, JTV, MP, MV, RKO, RKS, SLF, SLV, SLH, SLX, TV, XV** and **WB** are manufactured in accordance with the requirements of the following standard and EU-Directives.

- **EN ISO 12100-2010 "Safety of machines Basic terms, general design guidelines"**
- **Pressure Equipment Directive 97/23 EC (PED):** Art 3 Paragraph 1.3 or Art. 3 Paragraph 3 applies
The valves comply with this directive. The conformity rating procedure used according to Annex III of the Pressure Equipment Directive 97/23 EG is – For Category II Module A1
Notified body: **TÜV NORD Systems GmbH & Co. KG, Reg.-No. 0045**
- **Machine Directive 2006/42 EC (MD).** Automatically manoeuvred valves fulfil the demands in this directive as a "partly complete machine". This declaration is considered as a declaration of Incorporation. 2006/42 EC (MD) does not apply if the valve is actuated manually – observe the Table below
- **ATEX Directive 94/9 EC – the directive is fulfilled only when the valve is labelled with CE-marking**
The valves comply with this directive. The conformity rating procedure used according to EN13463-5:2003
"Non electric equipment intended for use in potentially explosive atmospheres – Part 5: Protection by con-structional safety "C"
- For Group II, Category 3 G/D (zone 2 and 22)

Product documents are available on the following:

Design documentation, Technical data sheets, catalogue pages

Stavsjö, 2013-01-13



Thomas Carlson, General Manager

To comply with the directive above, the following applies:

1. The use of the valve must comply with the <valve destination> defined in the "Original Installation and Service Manual ("IS-VALVES-en") supplied with the valve and must follow all instructions in this manual.
If this manual is not followed, the manufacturer may – in serious cases – be released from his product liability.
2. The valve shall not be put into operation (and the fitted actuator if any) until the conformity to all applicable EU directives above of the system into which the valve is fitted has been declared by the persons responsible. A separate declaration is supplied for the actuator named above.
3. Staffsjö Valves AB has made and documented the required risk analysis; the Staffsjö AB employee responsible for this documentation is Ulrika Björn, SE-618 95 Stavsjö.

Manufacturer STAFSJÖ Valves AB SE 61895 Stavsjö, Sweden, declares that a STAFSJÖ knife gate valve complies Directives 2006/42/EC as follows:	
Requirements as per Annex 1 of the Directive 2006/42/EC	
1.1.1, h) Valve destination	See original installation and service instruction.
1.1.2.,c) foreseeable misuse	See original installation and service instruction , section B1 och C1.
1.1.2.,d) protecting measures personnel	Same as the pipe section into which the valve is installed. See original installation and service instruction, section B1.
1.1.2.,e) accessories for maintenance	No special tools are necessary.
1.1.3 material in contact with the fluid	All valve material in contact with media are specified in the order acknowledgement and/or on the valve's marking. The relevant risk analysis is the responsibility of the user.
1.1.5 handling	See original installation and service instruction
1.2 and 6.2. control system	Is the responsibility of the user in combination with the instruction of the actuator.
1.3.2 withstand to stresses	For parts under pressure: See declaration of conformity to the PED 97/23/EC For functional parts: Ensured at contractual use of the valve.
1.3.4 sharp edges or angles	Requirements fulfilled.
1.3.7/8 risks related to moving parts	Requirements are fulfilled at contractual use of the valve, see original installation and service instruction. Observe the warnings. Delivered gate guards must be installed on the valve. No maintenance is allowed when the pipe line is pressurized or the automatic actuator is connected. If the valve is modified by the customer (new actuator) necessary protective devices shall be installed. Ask Staffsjö for support.
1.5.1 – 1.5.3 energy supply	In the responsibility of the user in combination with the instruction of the actuator.
1.5.5 contact to surface with high/low temp.	See warning in the "Original installation and service instruction"
1.5.7 -explosion	⚠-protection may be necessary. This shall be confirmed in Staffsjö's order acknowledgement. Observe the valve's marking and relevant instruction from Staffsjö.
1.5.13 emission of dangerous substances	Not applicable at not dangerous fluids. For dangerous fluids: pay attention when re-tightening the gland box. Personal safety equipment may be necessary.
1.6. maintenance	See original installation and service instruction
1.7.3 marking	Knife gate valve: see original installation and service instruction Actuator: see actuator instruction
1.7.4 service instruction	See original installation and service instruction and actuator instruction.
Requirements from Annex III	The knife gate valve is not a complete machine. No CE marking for conformity with the directive 2006/42/EG.
Requirements from Annexes IV, VIII to XI	Not applicable.