

Radar Transmitters

SITRANS LR260 (HART)

Operating Instructions · 12/2013



SITRANS

SIEMENS

Safety Guidelines: Warning notices must be observed to ensure personal safety as well as that of others, and to protect the product and the connected equipment. These warning notices are accompanied by a clarification of the level of caution to be observed.

Qualified Personnel: This device/system may only be set up and operated in conjunction with this manual. Qualified personnel are only authorized to install and operate this equipment in accordance with established safety practices and standards.

Unit Repair and Excluded Liability:

- The user is responsible for all changes and repairs made to the device by the user or the user's agent.
- All new components are to be provided by Siemens Milltronics Process Instruments.
- Restrict repair to faulty components only.
- Do not reuse faulty components.

Warning: Cardboard shipping package provides limited humidity and moisture protection. This product can only function properly and safely if it is correctly transported, stored, installed, set up, operated, and maintained.

This product is intended for use in industrial areas. Operation of this equipment in a residential area may cause interference to several frequency based communications.

Note: Always use product in accordance with specifications.

Copyright Siemens AG 2013. All Rights Reserved

Disclaimer of Liability

This document is available in bound version and in electronic version. We encourage users to purchase authorized bound manuals, or to view electronic versions as designed and authored by Siemens Milltronics Process Instruments. Siemens Milltronics Process Instruments will not be responsible for the contents of partial or whole reproductions of either bound or electronic versions.

While we have verified the contents of this manual for agreement with the instrumentation described, variations remain possible. Thus we cannot guarantee full agreement. The contents of this manual are regularly reviewed and corrections are included in subsequent editions. We welcome all suggestions for improvement.

Technical data subject to change.

MILLTRONICS® is a registered trademark of Siemens Milltronics Process Instruments.

Contact SMPI Technical Publications

at the following address:

Technical Publications
Siemens AG
Siemens Milltronics Process Instruments
1954 Technology Drive, P.O. Box 4225
Peterborough, Ontario, Canada, K9J 7B1
Email: techpubs.smpi@siemens.com

European Authorized Representative

Siemens AG
Industry Sector
76181 Karlsruhe
Deutschland

- For a selection of Siemens Milltronics level measurement manuals, go to: **www.siemens.com/processautomation**. Under Process Instrumentation, select *Level Measurement* and then go to the manual archive listed under the product family.
- For a selection of Siemens Milltronics weighing manuals, go to: **www.siemens.com/processautomation**. Under Weighing Technology, select *Continuous Weighing Systems* and then go to the manual archive listed under the product family.

Table of Contents

Table of Contents	i
Safety Notes	1
Safety marking symbols	1
FCC Conformity	1
CE Electromagnetic Compatibility (EMC) Conformity	2
The Manual	3
Technical Support	3
SITRANS LR260 Overview	5
Specifications	6
Power	6
Performance	6
Interface	7
Mechanical (Easy Aimer model)	7
Mechanical (Threaded Connection model)	8
Environmental	8
Process	8
Approvals	8
Programmer (infrared keypad)	9
Dimensions:	10
Threaded Horn Antenna with extension	11
Threaded Horn dimensions	12
.....	12
Installation	13
Mounting location	14
Nozzle design	14
Nozzle location	14
Orientation in a vessel with obstructions	15
Easy Aimer	16
Air Purging System (Optional)	17
Universal Slotted Flange	18
Dust Cap (Optional)	19
Wiring	20
Power	20
Connecting SITRANS LR260	20
Intrinsically Safe wiring	22
Non-Sparking wiring	24
Non-incendive wiring (US/Canada only)	24
For power demands see <i>Startup Behavior</i> on page 105.	24
Instructions specific to hazardous area installations	25
Quick Start via local operation	26
Activating SITRANS LR260	26
The LCD Display	26
Handheld Programmer (Part No. 7ML1930-2AJ)	28
Programming SITRANS LR260	29

Quick Start Wizard via the handheld programmer	32
Requesting an Echo Profile	34
Device Address	34
Auto False Echo Suppression	34
Level application example	35
Operating via SIMATIC PDM	36
Functions in SIMATIC PDM	36
Electronic Device Description (EDD)	37
Configuring a new device	37
Quick Start Wizard via SIMATIC PDM	37
Changing parameter settings using SIMATIC PDM	41
Parameters accessed via pull-down menus	41
Parameter Reference	49
Pull-down menus via SIMATIC PDM	49
Quick Start Wizard	50
Quick Start	50
Setup	52
Device	52
Input	52
Output	63
Fail-safe	66
Diagnostics	67
Echo Profile	67
Measured Values (MEAS. VALUES).....	67
Remaining Device Lifetime (REMAIN. DEV. LIFE.)	68
Remaining Sensor Lifetime (REMAIN SENS. LIFE.)	71
Service	73
Device Reset	73
Manufacture Date (MANUF. DATE)	73
LCD Fast Mode	74
LCD Contrast	74
Powered Hours	74
Power-on Resets.....	74
Memory Test (MEM. TEST)	74
Service Interval.....	75
Calibration Interval (CALIB. INTERVAL)	77
Communication	80
Device Address	80
Communication Control	80
Security	81
Lock	81
Unlock value	81
Language	81
Appendix A: Alphabetical Parameter List	83
Appendix B: Troubleshooting	87
Communication Troubleshooting	87
Device Status Icons	88
General Fault Codes	89
Operation Troubleshooting	93

Appendix C: Maintenance	95
Unit Repair and Excluded Liability	95
Appendix D: Technical Reference	96
Principles of Operation	96
Echo Processing	96
Process Intelligence	96
Time Varying Threshold (TVT) Curves	97
Echo Lock	97
Echo Position Detection	97
Auto False Echo Suppression	98
Measurement Range	98
Near Range	98
Far Range	99
Measurement Response	99
mA Output	99
Damping	100
Loss of Echo (LOE)	100
Fail-safe Mode	100
Fail-safe Timer	101
Fail-safe Material Level	101
Fail-safe Level	101
Process Pressure/Temperature derating curves	102
Horn Antenna	103
Loop power	104
Typical Connection Drawing	104
Allowable operating area of SITRANS LR260	104
Startup Behavior	105
Appendix E: Application Example	107
Flour in steel storage vessel, level measurement	107
Appendix F: HART Communications	109
SIMATIC PDM	109
HART Electronic Device Description (EDD)	109
HART Version	109
HART Burst Mode	109
HART Multidrop	109
HART Communicator 375 Menu Structure	110
Supported HART Commands	113
Universal and Common Practice Commands	113
Device Specific Commands	113
Appendix G: Firmware Revision History	114
Glossary	115
Index	119
LCD menu structure	121

Notes

Safety Notes

Special attention must be paid to warnings and notes highlighted from the rest of the text by grey boxes.



WARNING: relates to a caution symbol on the product, and means that failure to observe the necessary precautions can result in death, serious injury, and/or considerable material damage.



WARNING¹: means that failure to observe the necessary precautions can result in death, serious injury, and/or considerable material damage.

Note: means important information about the product or that part of the operating manual.

Safety marking symbols

In manual	On product	Description
		Earth (ground) Terminal
		Protective Conductor Terminal
		(Label on product: yellow background.) WARNING: refer to accompanying documents (manual) for details.

FCC Conformity

US Installations only: Federal Communications Commission (FCC) rules



WARNING: Changes or modifications not expressly approved by Siemens Milltronics could void the user's authority to operate the equipment.

Notes:

- This equipment has been tested and found to comply with the limits for a Class A digital device, pursuant to Part 15 of the FCC Rules. These limits are designed to provide reasonable protection against harmful interference when the equipment is operated in a commercial environment.
- This equipment generates, uses, and can radiate radio frequency energy and, if not installed and used in accordance with the instruction manual, may cause harmful interference to radio communications. Operation of this equipment in a residential area is likely to cause harmful interference to radio communications, in which case the user will be required to correct the interference at his own expense.

¹⁾ This symbol is used when there is no corresponding caution symbol on the product.

CE Electromagnetic Compatibility (EMC) Conformity

This equipment has been tested and found to comply with the following EMC Standards:

EMC Standard	Title
CISPR 11:2004/EN 55011:1998+A1:1999&A2:2002, CLASS B	Limits and methods of measurements of radio disturbance characteristics of industrial, scientific, and medical (ISM) radio-frequency equipment.
EN 61326:1997+A1:1998+A2:2001+A3:2003 (IEC 61326:2002)	Electrical Equipment for Measurement, Control and Laboratory Use – Electromagnetic Compatibility.
EN61000-4-2:2001	Electromagnetic Compatibility (EMC) Part 4-2:Testing and measurement techniques – Electrostatic discharge immunity test.
EN61000-4-3:2002	Electromagnetic Compatibility (EMC) Part 4-3: Testing and measurement techniques – Radiated, radio-frequency, electromagnetic field immunity test.
EN61000-4-4:2004	Electromagnetic Compatibility (EMC) Part 4-4: Testing and measurement techniques – Electrical fast transient/burst immunity test.
EN61000-4-5:2001	Electromagnetic Compatibility (EMC) Part 4-5: Testing and measurement techniques – Surge immunity test.
EN61000-4-6:2004	Electromagnetic Compatibility (EMC) Part 4-6: Testing and measurement techniques – Immunity to conducted disturbances, induced by radio-frequency fields.
EN61000-4-8:2001	Electromagnetic Compatibility (EMC) Part 4-8: Testing and measurement techniques – Power frequency magnetic field immunity test.

The Manual

Notes:

- Please follow the installation and operating procedures for a quick, trouble-free installation and to ensure the maximum accuracy and reliability of your SITRANS LR260.
- This manual applies to the SITRANS LR260 (HART) only.

This manual will help you set up your SITRANS LR260 for optimum performance. We always welcome suggestions and comments about manual content, design, and accessibility. Please direct your comments to techpubs.smpi@siemens.com.

For other Siemens Milltronics level measurement manuals, go to: www.siemens.com/level and look under **Level Measurement**.

Application Examples

The application examples used in this manual illustrate typical installations using SITRANS LR260 (see *Appendix E: Application Example* on page 107). Because there is often a range of ways to approach an application, other configurations may also apply.

In all examples, substitute your own application details. If the examples do not apply to your application, check the applicable parameter reference for the available options.

Technical Support

Support is available 24 hours a day.

To find your local Siemens Automation Office address, phone number, and fax number go to:

www.siemens.com/automation/partner

- Click on the tab **Contacts by Product** and then find your product group (**+Process Automation > +Process Instrumentation > +Level Measuring Instruments**).
- Select the team **Technical Support**. Click on **Next**.
- Click on the appropriate continent, then select the country followed by the city. Click on **Next**.

For on-line technical support go to:

www.siemens.com/automation/support-request

- Enter the device name (SITRANS LR260) or order number, then click on **Search**, and select the appropriate product type. Click on **Next**.
- You will be prompted to enter a keyword describing your issue. Then either browse the relevant documentation, or click on **Next** to email a detailed description of your issue to Siemens Technical Support staff.

Siemens A&D Technical Support Center: phone +49 180 50 50 222
 fax +49 180 50 50 223

Abbreviations and Identifications

Short form	Long Form	Description	Units
A/D	Analog to digital		
CE / FM / CSA	Conformité Européenne / Factory Mutual / Canadian Standards Association	safety approval	
C _i	Internal capacitance		F
D/A	Digital to analog		
DAC	Digital Analog Converter		
DCS	Distributed Control System	control room apparatus	
dK	dielectric constant		
ESD	Electrostatic Discharge		
HART	Highway Addressable Remote Transducer		
I _i	Input current		mA
I _o	Output current		mA
IS	Intrinsically Safe	safety approval	
L _i	Internal inductance		mH
mH	milliHenry	10 ⁻³	H
μF	microFarad	10 ⁻⁶	F
μs	microsecond	10 ⁻⁶	s
PED	Pressure Equipment Directive	safety approval	
pF	pico Farads	10 ⁻¹²	F
ppm	parts per million		
PV	Primary Variable	measured value	
SV	Secondary Variable	equivalent value	
TVT	Time Varying Threshold	sensitivity threshold	
U _i	Input voltage		V
U _o	Output voltage		V

SITRANS LR260 Overview

SITRANS LR260 is a 2-wire 25 GHz pulse radar level transmitter for continuous monitoring of solids and liquids in storage vessels including extreme levels of dust and high temperatures, to a range of 30 m (98.4 ft).

The instrument consists of an electronic component coupled to a horn antenna with an integral Easy Aimer and flange or threaded connection for quick and easy positioning. A dust cover or air purging are available as options.

SITRANS LR260 supports HART¹⁾ communication protocol, and SIMATIC PDM software. Signals are processed using Process Intelligence which has been field-proven in over 1,000,000 applications worldwide (ultrasonic and radar).

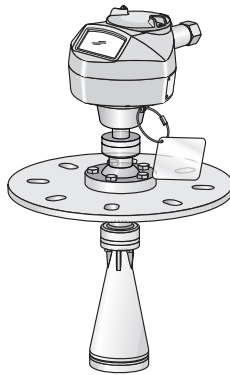

Programming

SITRANS LR260 is very easy to install and configure via a graphical local user interface (LUI). You can modify the built-in parameters either locally via the Siemens infrared handheld programmer, or from a remote location via SIMATIC PDM.

Applications

- cement powder, plastic powder/pellets, grain, flour, coal, and other applications
- solids and liquids bulk storage vessels

Approvals and Certificates

SITRANS LR260 is available with General Purpose approval, or for Hazardous areas. For details, see *Approvals* on page 8.

¹⁾ HART[®] is a registered trademark of the HART Communication Foundation

Specifications

Note: Siemens Milltronics makes every attempt to ensure the accuracy of these specifications but reserves the right to change them at any time.

Power



Nominal 24 V DC with max. 550 Ohm loop resistance:

For other configurations, see the chart under *Loop power* on page 104

- Maximum 30 V DC
- 4 to 20 mA
- Max startup current see *Startup Behavior* on page 105

Performance

Reference operating conditions according to IEC 60770-1

- ambient temperature +15 to +25 °C (+59 to +77 °F)
- humidity 45% to 75% relative humidity
- ambient pressure 860 to 1060 mbar g (86000 to 106000 N/m² g)

Measurement Accuracy (measured in accordance with IEC 60770-1)

- Maximum measured error (including hysteresis and non-repeatability)
 - 25 mm (1") from minimum detectable distance to 300 mm (11.8")
 - Remainder of range = 10 mm (0.39") or 0.1% of span (whichever is greater)

Frequency K-band (25 GHz nominal)

Max. measurement range¹⁾

- solids
 - 2" horn: 10 m (32.8 ft)
 - 3" horn: 20 m (65.6 ft)
 - 4" horn: 30 m (98.4 ft)
- liquids
 - 2" horn: 20 m (65.6 ft)
 - 3" horn: 30 m (98.4 ft)
 - 4" horn: 30 m (98.4 ft)

Min. detectable distance²⁾ 0.05 m (1.97") from end of horn

Update time³⁾ minimum 2 seconds, depending on settings for **Response Rate (2.2.7.1.)** and **LCD Fast Mode (4.3.)**

¹⁾ From sensor reference point.

²⁾ See *Dimensions*: on page 10.

³⁾ Reference conditions: **Response Rate (2.2.7.1.)** set to **FAST** and **LCD Fast Mode (4.3.)** set to **ON**

Influence of ambient temperature	< 0.003%/K (average over full temperature range, referenced to maximum range)
Dielectric constant of material measured	
• Minimum dK	= 1.6 (depending on antenna and application type)
Memory:	
• non-volatile EEPROM	
• no battery required.	

Interface

Analog output	
• signal range	4 to 20 mA (± 0.02 mA accuracy) upper limit 20 to 23 mA adjustable
• fail signal	3.6 mA to 23 mA; or last value
• load	Max. 600 Ω
Communication: HART	
• Load	230 to 600 Ω , 230 to 500 Ω when connecting a coupling module
• Max. Line Length	multi-wire: ≤ 1500 m (4921 ft)
• Protocol	HART ¹⁾ , Version 5.1
Configuration	Siemens SIMATIC PDM (PC), or Siemens Milltronics infrared handheld programmer, or HART handheld communicator
Display (local) ²⁾	graphic LCD, with bar graph representing level

Mechanical (Easy Aimer model)

Materials	
• flange and horn	304 stainless steel
Process Connections:	
• universal flanges ³⁾	2"/50 mm, 3"/80 mm, 4"/100 mm, 6"/150 mm
Horn:	
• 2" horn	
• 3" horn	
• 4" horn	
Enclosure	
• construction	aluminum, polyester powder-coated
• conduit entry	2 x M20x1.5, or 2 x 1/2" NPT
• ingress protection	Type 4X/NEMA 4X, Type 6/NEMA 6, IP67, IP68
Dust cap (optional)	
• 2"	PTFE, pipe clamp connection, O.D. 50 mm (1.97")
• 3"	PTFE, pipe clamp connection, O.D. 75 mm (2.95")
• 4"	PTFE, pipe clamp connection, O.D. 100 mm (3.94")

¹⁾ HART® is a registered trademark of HART Communication Foundation.

²⁾ Display quality will be degraded in temperatures below -25 °C (-13 °F) and above $+65$ °C ($+149$ °F).

³⁾ Universal flange mates with EN 1092-1 (PN16)/ASME B16.5 (150 lb)/JIS 2220 (10K) bolt hole pattern.

Air Purge Connection

- equipped with female 1/8" NPT fitting

Weight

- standard model < 8.14 kg (17.9 lb) including 4" flange and standard Easy Aimer with 4" horn antenna

Mechanical (Threaded Connection model)

- threaded connection 2" NPT (ASME B1.20.1), R (BSPT, EN 10226-1) or G (BSPP, EN ISO 228-1)
- materials 316L /1.4404 or 316L /1.4435 stainless steel
PTFE emitter

Environmental

Notes:

- Check *Approvals* on page 8, for the specific configuration you are about to use or install.
- Use appropriate conduit seals to maintain IP or NEMA rating.

- location indoor/ outdoor
- altitude 2000 m (6562 ft) max.
- ambient temperature -40 to +80 °C (-40 to +176 °F)
- relative humidity suitable for outdoor
Type 4X/NEMA 4X, Type 6/NEMA 6, IP67 enclosure (see note below)
- installation category I
- pollution degree 4

Process

- temperature¹⁾ -40 to 200 °C (-40 to 392 °F)²⁾
(at process connection with FKM O-ring)
- pressure (vessel)¹⁾ Refer to *Process Pressure/Temperature derating curves* on page 102.

Approvals

Note: The device nameplate lists the approvals that apply to your device.

- General CSA_{US/C}, FM, CE, C-TICK
- Radio Europe (R&TTE), FCC, Industry Canada
- Hazardous ATEX II 1G, 1/2D, 2D Ex ia IIC T4 Ga, Ex ta IIC T100 °C Da
ATEX II 3G Ex nA IIC T4 Gc
IECEx SIR 11.0153X Ex ia IIC T4 Ga, Ex ta IIIC T100 °C Da

¹⁾ The maximum temperature is dependent on the ambient temperature and vessel pressure. For more detail, or for other configurations, see *Process Pressure/Temperature derating curves* on page 102, and *Process Pressure/Temperature derating curves* on page 102.

²⁾ Pressure rated version for maximum process temperature of 80 °C (176 °F)

FM/CSA Class I, Div. 1, Groups A, B, C, D, Class II, Div. 1,
 Groups E, F, G, Class III T4
 FM/CSA Class I, Div 2, Groups A, B, C, D T5
 SABS ARP0108 Ex ia IIC T4 Ga
 INMETRO: DNV 12.0081 X
 Ex ia IIC T4 Ga
 Ex ta IIIC T100 °C Da
 -40 °C ≤ Ta ≤ +80 °C
 IP67/IP68
 DNV #OCP 0017
 ABNT NBR IEC 60079-0:2008
 ABNT NBR IEC 60079-11:2009
 ABNT NBR IEC 60079-26:2008 e
 ABNT NBR IEC 60079-31:2011

Programmer (infrared keypad)

Siemens Milltronics Infrared IS (Intrinsically Safe) Hand Programmer for hazardous and all other locations (battery is non-replaceable)

- approval
 - ATEX II 1GD, Ex ia IIC T4 Ga, Ex iaD 20 T135 °C,
SIRA 01ATEX2147
 - IECEx SIR 09.0073 Ex ia IIC T4 Ga, Ex iaD 20 T135 °C
 - FM/CSA: Class I, Div. 1, Groups A, B, C, D
 - INMETRO: DNV 12.0075
 - Ex ia IIC T4 Ga
 - Ex ia IIIC T135 °C Da
 - DNV #OCP 0017
 - ABNT NBR IEC 60079-0:2008
 - ABNT NBR IEC 60079-11:2009
 - ABNT NBR IEC 60079-26:2008 e IEC 61241-11:2005
- ambient temperature
 - 20 to +50 °C (-5 to +122 °F)
- interface
 - proprietary infrared pulse signal
- power
 - 3 V lithium battery
- weight
 - 150 g (0.3 lb)
- color
 - black
- Part Number
 - 7ML1930-1BK

Dimensions:

Notes:

- Process temperature and pressure capabilities are dependent upon information on the process device tag.
- Signal amplitude increases with horn diameter, so use the largest practical size.

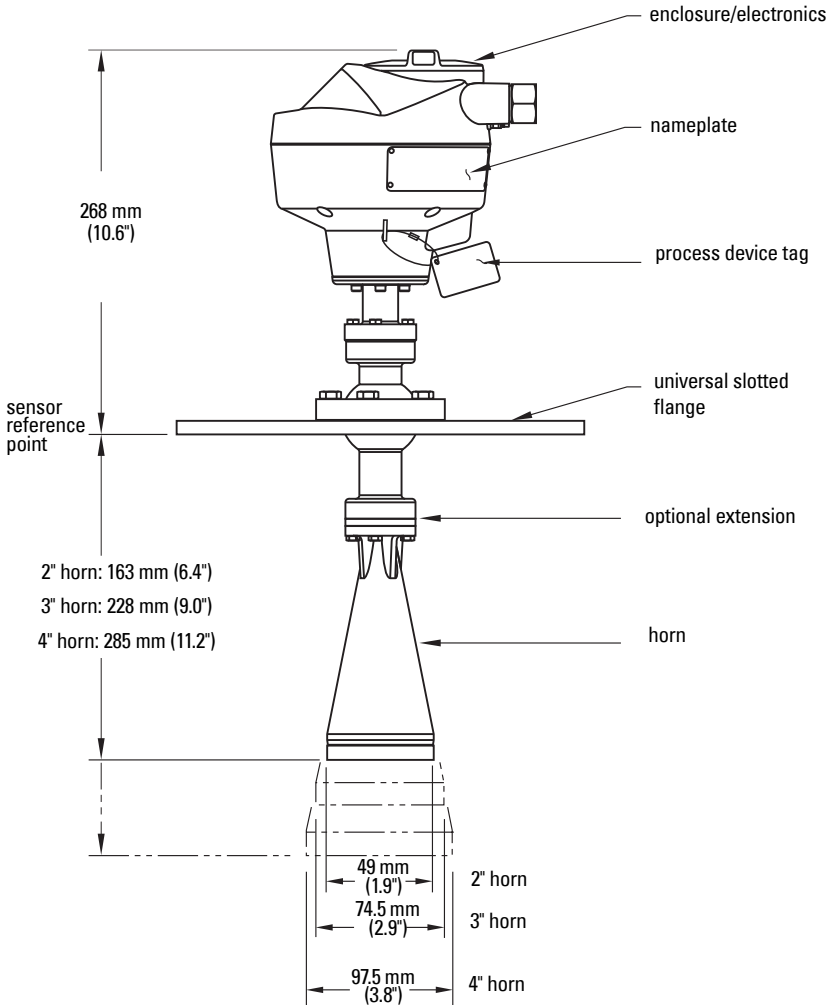

Threaded Horn Antenna with extension

Notes:

- Process temperature and pressure capabilities are dependent upon information on the process connection tag.
- Signal amplitude increases with horn diameter, so use the largest practical size.
- Optional extensions can be installed below the threads.

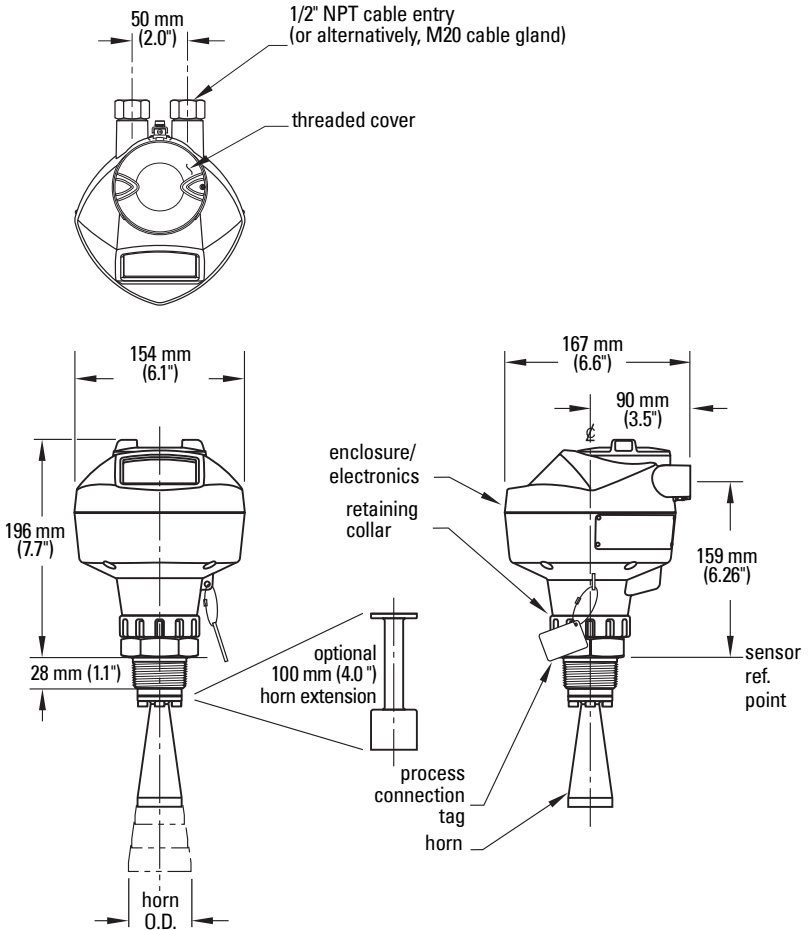

See table under *Threaded Horn dimensions* on page 12 for horn height to sensor reference point.

Threaded Horn dimensions

Antenna Type	Antenna O.D.	Height to sensor reference point ^{a)}			Beam Angle ^{b)}	Measurement Range
		1-1/2" threaded connection	2" threaded connection	3" threaded connection		
2" Horn	47.8mm (1.88")	N/A	166mm (6.55")	180mm (7.09")	15 degrees	20m (65.6 ft)
3" Horn	74.8mm (2.94")	N/A	199mm (7.85")	213mm (8.39")	10 degrees	20m (65.6 ft)
4" Horn	94.8mm (3.73")	N/A	254mm (10")	268mm (10.55")	8 degrees	20m (65.6 ft)

- a) Height from bottom of horn to sensor reference point as shown: see *Threaded Horn Antenna with extension* on page 11.
- b) – 3dB in the direction of the polarization axis (see *Polarization reference point* on page 15 for an illustration).

Installation



• WARNINGS:

- **Installation shall only be performed by qualified personnel and in accordance with local governing regulations.**
- **SITRANS LR260 is to be used only in the manner outlined in this manual, otherwise protection provided by the device may be impaired.**
- **Never attempt to loosen, remove, or disassemble process connection or instrument housing while vessel contents are under pressure.**
- **This product is designated as a Pressure Accessory per Directive 97/23/EC and is not intended for use as a safety device.**
- **Materials of construction are chosen based on their chemical compatibility (or inertness) for general purposes. For exposure to specific environments, check with chemical compatibility charts before installing.**
- **The user is responsible for the selection of bolting and gasket materials which will fall within the limits of the flange and its intended use and which are suitable for the service conditions.**
- **Improper installation may result in loss of process pressure.**

Notes:

- For European Union and member countries, installation must be according to ETSI EN 302372.
- Refer to the device nameplate for approval information.
- The Process Device Tag shall remain with the process pressure boundary assembly¹. In the event the instrument package is replaced, the Process Device Tag shall be transferred to the replacement unit.
- SITRANS LR260 units are hydrostatically tested, meeting or exceeding the requirements of the ASME Boiler and Pressure Vessel Code and the European Pressure Equipment Directive.
- The serial numbers stamped in each process connection body provide a unique identification number indicating date of manufacture.
Example: MMDDYY – XXX (where MM = month, DD = day, YY = year, and XXX= sequential unit produced)
Further markings (space permitting) indicate flange configuration, size, equivalent pressure class, material, and material heat code.

¹⁾ The process pressure boundary assembly comprises the components that act as a barrier against pressure loss from the process vessel: that is, the combination of process connection body and emitter, but normally excluding the electrical enclosure.

Mounting location

Notes:

- Correct location is key to a successful application.
- Avoid reflective interference from vessel walls and obstructions by following the guidelines below.

Nozzle design

- The end of the horn must protrude a minimum of 10 mm (0.4") to avoid false echoes being reflected from the nozzle.
- Optional antenna extensions: 100 mm (3.93"), 200 mm (70.9"), 500 mm (19.69"), 1000 mm (39.4")¹⁾

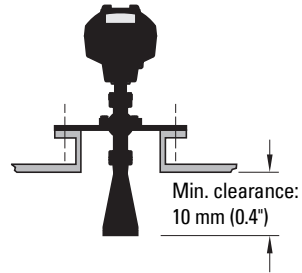

Nozzle location

Notes:

- Beam angle depends on horn size: see below.
- For details on avoiding false echoes, see *Auto False Echo Suppression* on page 98.

- Keep emission cone free of interference from ladders, pipes, I-beams or filling streams.
- Avoid central locations on tall, narrow vessels.
- Align the antenna so that the radar cone is perpendicular to the surface of the monitored material, if possible. (See *Easy Aimer* on page 16.)

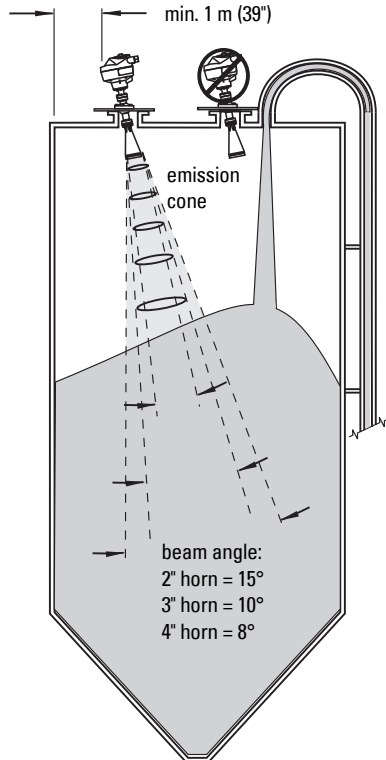

¹⁾ Extensions are not recommended for applications where there may be excessive visible vibration. Please consult factory for more information.

Nozzle location (continued)

- Provide easy access for viewing the display and programming via the hand programmer.
- Provide an environment suitable to the housing rating and materials of construction.
- Provide a sunshield if the instrument will be mounted in direct sunlight.

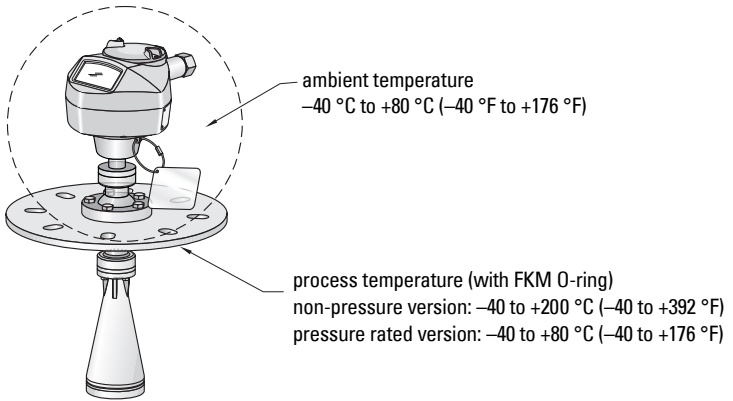

Orientation in a vessel with obstructions

Polarization reference point

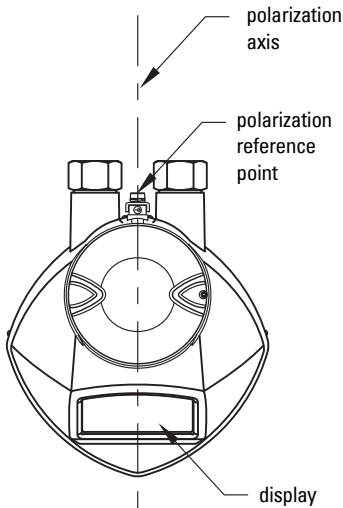

For best results on a vessel with obstructions, orient the front or back of the device toward the obstructions.

Easy Aimer

Note: When the Easy Aimer ball is loosened, the device is free to tilt to a maximum of 30°.

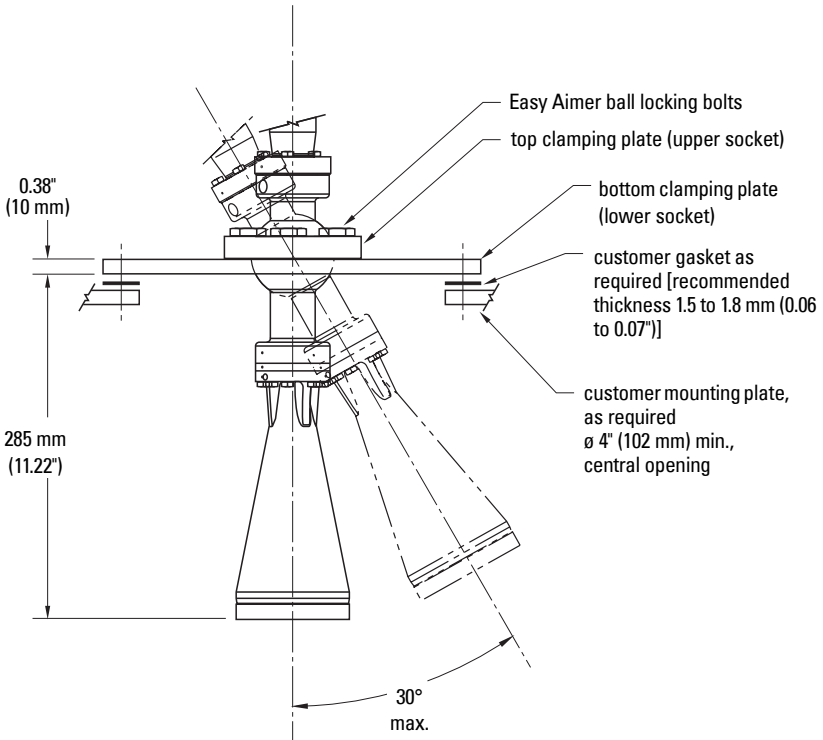

1. Holding the electronics enclosure firmly, loosen the Easy Aimer ball locking bolts and gently reposition the enclosure.
2. Direct SITRANS LR260 so the horn antenna is pointed at an angle perpendicular to the material surface, if possible. (As a guide, aim the beam at a point approximately 2/3 of the way across the tank diameter.)
3. When the desired position is reached, retighten the 5 bolts to 15-23 Nm (11 to 17 Lbf-ft).

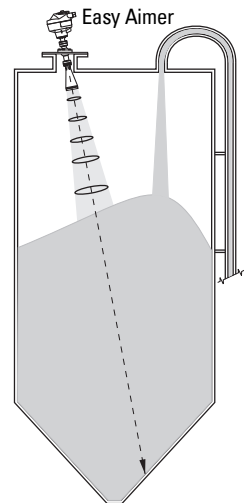

Air Purging System (Optional)

For more frequent cleaning, a purging system can be installed between the flange and the horn antenna. The system provides an 1/8" inlet (female thread) on the flange where cooling air or cleaning fluid passes through the flange and exits the inside of the horn to clean it. The customer will supply the purging medium by a manual or automatic valve system.

This option is only available with the universal flange for purging shown on page 18.

Notes:

- The Air Purge feature should not be activated with a dust cap in place.
- Purge duration, pressure, and interval, will vary with each application. It is the user's responsibility to determine the requirements depending on the application and cleaning required.
- Short duration bursts of high pressure provide more effective cleaning than continuous low pressure air.
- Some dust particles are highly abrasive and can be drawn into the inside of the horn during purge cleaning, damaging the internal PTFE emitter of the antenna. A replacement kit is available from your local Siemens Milltronics representative.
- It is the customer's responsibility to ensure that any vacuum or pressure in the measured vessel is maintained, considering the hole that passes through the process connection and SITRANS LR260 antenna system.

Air Consumption (Flow rate versus applied pressure)

Air Pressure (psi) ²⁾	Approx. inlet volume flow rate
20 ³⁾	5 SCFM
40 ³⁾	6 SCFM
60	8 SCFM
80	9 SCFM
90	10 SCFM
Recommended 90 to 110 psi for effective cleaning with inlet flow of 10 SCFM ¹⁾	

- The purge connection is closed by the manufacturer, using a 1/8" plug.
- When the plug is removed to connect a purging system, the operator is responsible for ensuring that the purging circuit conforms to "Ex" requirements: for example, by fitting an NRV valve.

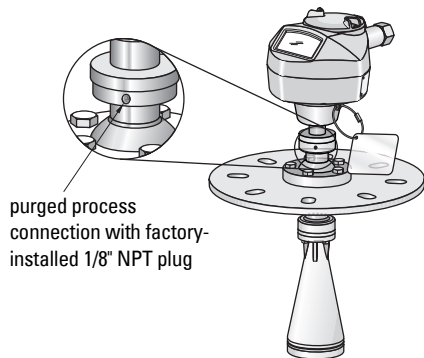

¹⁾ SCFM (standard cubic feet/minute) referenced to 14.7 psia, +68 °F and 36% relative humidity (RH).

²⁾ Air pressure in vessel can affect purge operation.

³⁾ Not for pressure applications

Universal Slotted Flange

! WARNING: The user is responsible for the selection of bolting and gasket materials which will fall within the limits of the flange and its intended use and which are suitable for the service conditions.

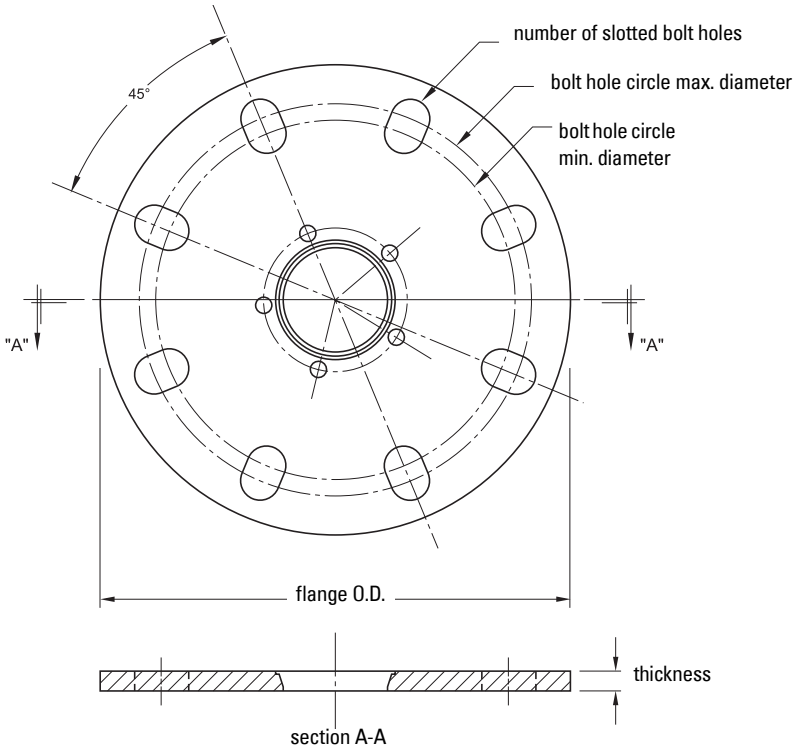

Slotted Flange Dimensions¹⁾

Pipe Size	Flange O.D.	Thick-ness (s)	Bolt Hole Circle Max Ø	Bolt Hole Circle Min Ø	Bolt Hole radius	No. of Slotted Holes
2" or 50 mm	6.50" (165 mm)	0.38" (9.65 mm)	4.92" (125 mm)	4.72" (120 mm)	0.38" (9.65 mm)	4
3" or 80 mm	7.87" (200 mm)	0.38" (9.65 mm)	6.30" (160 mm)	5.91" (150 mm)	0.38" (9.65 mm)	8
4" or 100 mm	9.00" (229 mm)	0.38" (9.65 mm)	7.52" (191 mm)	6.89" (175 mm)	0.38" (9.65 mm)	8
6" or 150 mm	11.22" (285 mm)	0.38" (9.65 mm)	9.53" (242 mm)	9.45" (240 mm)	0.45" (11.5 mm)	8

¹⁾ Universal flange mates with EN 1092-1 (PN16)/ASME B16.5 (150 lb)/JIS 2220 (10K) bolt hole pattern.

Dust Cap (Optional)

Note: The dust cap must be removed before using the Air Purge feature (see *Air Purging System (Optional)* on page 17).

The dust cap fits onto the end of the horn and prevents the buildup of dust and other process material inside the horn.

- It is particularly useful for applications in areas of high humidity, or with bulk solids with a high moisture content.
- Three sizes are available, to fit the standard 2", 3" and 4" horns.

Installation

1. Thoroughly clean inside the horn. If you remove the horn for easier cleaning, take care not to damage or bend the plastic emitter.

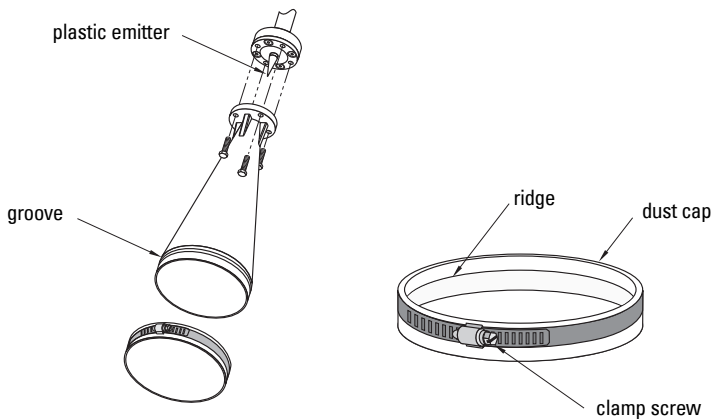

2. Press the cap firmly onto the horn until the ridge inside the cap snaps into position in the groove on the outside of the horn.
3. Hand tighten the adjustable clamp supplied to secure the cap.
4. Use a screwdriver or nut driver to tighten the clamp screw until the clamp provides an air-tight seal.

Note: It is critical to ensure no moisture can be trapped inside.

Wiring

Power

WARNINGS:



The DC input terminals shall be supplied from a source providing electrical isolation between the input and output, in order to meet the applicable safety requirements of IEC 61010-1.



All field wiring must have insulation suitable for rated voltages.

Connecting SITRANS LR260



WARNINGS:

- Check the nameplate on your instrument, to verify the approval rating.
- Use appropriate conduit seals to maintain IP or NEMA rating.
- Read *Instructions specific to hazardous area installations* on page 25.

Notes:

- Use twisted pair cable: AWG 22 to 14 (0.34 mm² to 2.5 mm²).
- Separate cables and conduits may be required to conform to standard instrumentation wiring practices or electrical codes.

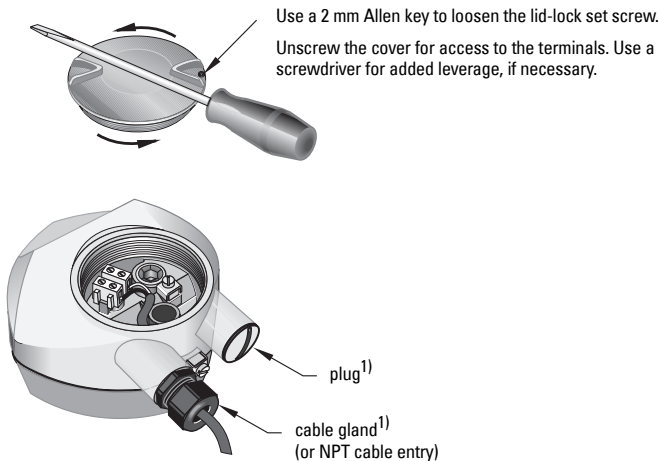

¹⁾ Depending on the approval rating, glands and plugs may be supplied with your instrument.

1. Strip the cable jacket for approximately 70 mm (2.75") from the end of the cable, and thread the wires through the gland¹⁾.
2. Connect the wires to the terminals as shown: the polarity is identified on the terminal block.
3. Ground the instrument according to local regulations.
4. Tighten the gland to form a good seal.

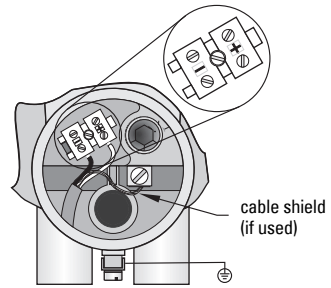

Connecting HART

Typical PLC/mA configuration with HART

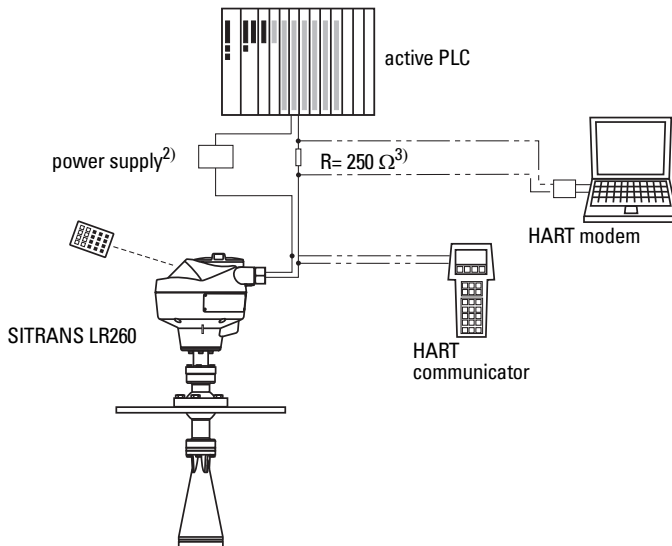

- 1) If cable is routed through conduit, use only approved suitable-size hubs for waterproof applications.
- 2) Depending on the system design, the power supply may be separate from the PLC, or integral to it.
- 3) Loop resistance (total of cable resistance plus 250 Ohm [resistor]) must be less than 550 Ohm for the device to function properly.

1. Intrinsically Safe wiring

Device nameplate (ATEX/IECEX/INMETRO/C-TICK)

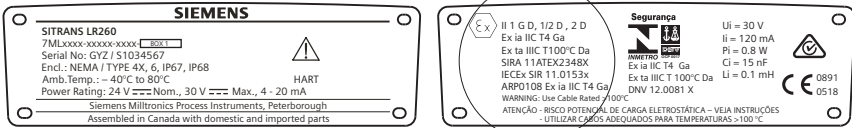

The ATEX certificate listed on the nameplate can be downloaded from the product page of our website at: www.siemens.com/LR260. Go to **Support > Approvals / Certificates**.

The IECEx certificate listed on the nameplate can be viewed on the IECEx website. Go to: <http://iecex.iec.ch> and click on **Ex Equipment Certificates of Conformity** then enter the certificate number IECEx SIR 11.0153X.

Device nameplate (FM/CSA)

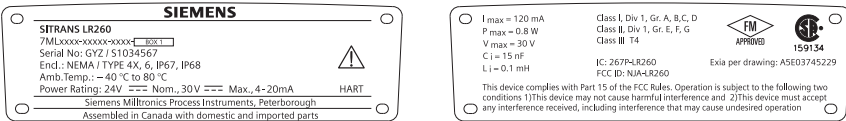

FM/CSA Intrinsically Safe connection drawing number **A5E03745229** can be downloaded from the product page of our website at: www.siemens.com/LR260. Go to **Support > Installation Drawings > Level Measurement > Continuous - Radar**.

- For power demands see *Startup Behavior* on page 105.
- For wiring requirements: follow local regulations.
- Approved dust-tight and water-tight conduit seals are required for outdoor NEMA 4X / type 4X / NEMA 6, IP67, IP68 locations.
- Refer to *Instructions specific to hazardous area installations* on page 25.
- Recommended intrinsically safe barriers are listed under *Passive Shunt Diode Barriers* on page 23 and *Active barriers (repeating barriers)* on page 23.

Note: Selecting a suitable PLC input module, power supply, or barrier requires knowledge about Intrinsic Safety and the application. It is the responsibility of the installer to ensure that the intrinsically safe installation complies with both the apparatus approval requirements and the relevant national code of practice.

Passive Shunt Diode Barriers

Note: A well regulated supply voltage is required.

Manufacturer	Part Number
MTL	787SP+ (Dual Channel)
MTL	7787P+ (Dual Channel)
Stahl	9001/01-280-100-10 (Single Channel)
Stahl	9002/01-280-110-10 (Dual Channel)

How to select a passive barrier for SITRANS LR260

To make sure that the barrier safety description is suitable for the LR260 Intrinsically Safe (IS) input parameters, carry out the following calculations:

- Re-e = max. end-to-end resistance of the barrier
Rloop = loop resistance (total of cable resistance plus any additional series resistance, for example, PLC inputs and/or displays)
Vbarrier = value of any non-linear voltage drops due to the barrier

- 1) Determine the value for Re-e from the data sheet.
- 2) Calculate the total value for Rloop.
- 3) Calculate Rworking = Re-e + Rloop.
- 4) Determine the value of Vbarrier from the barrier data sheet (for example, voltage drops due to diodes).
- 5) Calculate Vworking = Vsupply – Vbarrier.

Use the values for Vworking and Rworking to confirm that operation is within the shaded area of the graph *Startup Behavior* on page 105.

Active barriers (repeating barriers)

Manufacturer	Part Number
MTL	706
MTL	7206
Siemens	SITRANS I 7NG4122
Stahl	9001/51-280-110-14
MTL	E02009
MTL	E02010

2. Non-Sparking wiring

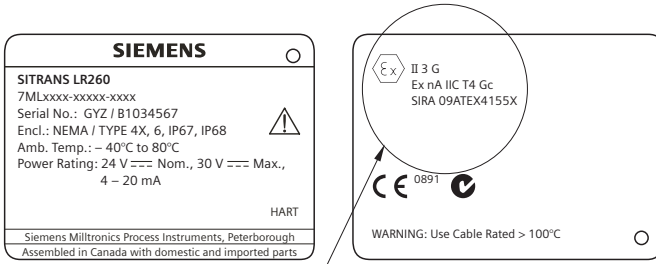

The ATEX certificate listed on the nameplate can be downloaded from the product page of our website at: www.siemens.com/LR260. Go to **Support > Approvals / Certificates**.

- For power demands see *Startup Behavior* on page 105.
- For wiring requirements: follow local regulations.
- Refer to *Instructions specific to hazardous area installations* on page 25.

3. Non-incendive wiring (US/Canada only)

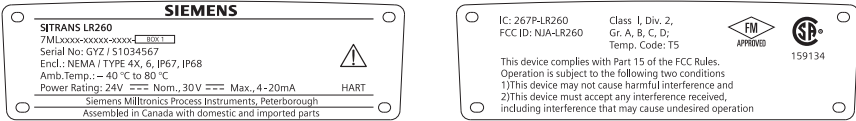

FM/CSA Class 1, Div 2 connection drawing number A5E03745541 can be downloaded from the product page of our website at: www.siemens.com/LR260. Go to **Support > Installation Drawings > Level Measurement > Continuous - Radar**.

- For power demands see *Startup Behavior* on page 105.

Instructions specific to hazardous area installations

(Reference European ATEX Directive 94/9/EC, Annex II, 1/0/6)

The following instructions apply to equipment covered by certificate number SIRA 11ATEX2348X, and SIRA 09ATEX4155X.

- 1) For use and assembly, refer to the main instructions.
- 2) The equipment is certified for use as Category 1GD, 1/2D, 2D equipment per SIRA 11ATEX2348X; and Category 3G equipment per SIRA 09ATEX4155X.
- 3) The equipment may be used with flammable gases and vapors with apparatus group IIC, IIB and IIA and temperature classes T1, T2, T3 and T4.
- 4) The equipment has a degree of ingress protection of IP67 and a temperature class of T100°C and may be used with flammable dusts.
- 5) The equipment is certified for use in an ambient temperature range of -40 °C to 80 °C.
- 6) The equipment has not been assessed as a safety related device (as referred to by Directive 94/9/EC Annex II, clause 1.5).
- 7) Installation and inspection of this equipment shall be carried out by suitably trained personnel in accordance with the applicable code of practice (EN 60079-14 and EN 60079-17 in Europe).
- 8) The equipment is non-repairable.
- 9) The certificate numbers have an 'X' suffix, which indicates that special conditions for safe use apply. Those installing or inspecting this equipment must have access to the certificates.
- 10) If the equipment is likely to come into contact with aggressive substances, then it is the responsibility of the user to take suitable precautions that prevent it from being adversely affected, thus ensuring that the type of protection is not compromised.
 - Aggressive substances: for example, acidic liquids or gases that may attack metals, or solvents that may affect polymeric materials.
 - Suitable precautions: for example, establishing from the material's data sheet that it is resistant to specific chemicals.

SPECIAL CONDITIONS FOR SAFE USE

The 'X' suffix to the certificate number relates to the following special condition(s) for safe use:

- Unused cable entries shall be fitted with blanking elements that can only be removed with the aid of a tool.
- Any glands, conduit entry devices or blanking elements fitted to the equipment shall be suitable for use in the presence of combustible dusts and certified as such by a notified body; the installation of these devices shall not compromise the IP6X rating of the equipment enclosure.
- For applications that use the purge facility, the user shall provide a means to ensure that combustible dust from the hazardous area cannot enter the purge supply in such a way as to compromise the area classification.

Quick Start via local operation

SITRANS LR260 carries out its level measurement tasks according to settings made via parameters. The settings can be modified locally via the Local User Interface (LUI) which consists of an LCD display and a handheld programmer.

A Quick Start Wizard provides an easy step-by-step guide to help you configure the device for a simple application. There are two ways to access the wizard:

- 7-step *Quick Start Wizard via the handheld programmer* on page 32
- 4-step *Quick Start Wizard via SIMATIC PDM* on page 37 for programming via SIMATIC PDM.

For more complex setups, see *Appendix E: Application Example* on page 107, and for the complete range of parameters, see *Parameter Reference* on page 49.

Activating SITRANS LR260

Power up the instrument. SITRANS LR260 automatically starts up in Measurement mode. Press **Mode**  to toggle between Measurement and Program Mode.

The LCD Display

Measurement mode

Normal operation

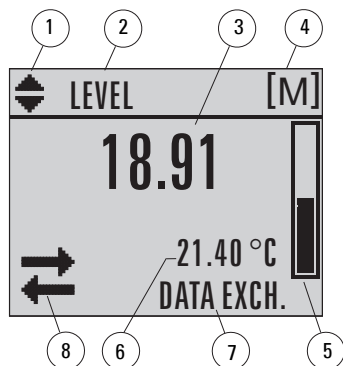

- 1 – toggle indicator for linear units or %
- 2 – selected operation: level, space, or distance
- 3 – measured value (level, space, or distance)
- 4 – units
- 5 – bar graph indicates level
- 6 – secondary region indicates on request¹ electronics temperature, echo confidence, loop current, or distance
- 7 – text area displays status messages
- 8 – device status indicator

Fault present



- 7 – text area displays a fault code and an error message
- 8 – service required icon appears

¹⁾ In response to a key press request. For details, see *Key functions in Measurement mode* on page 28.

PROGRAM mode display

Navigation view

- A visible menu bar indicates the menu list is too long to display all items.
- A band halfway down the menu bar indicates the current item is halfway down the list.
- The depth and relative position of the item band on the menu bar indicates the length of the menu list, and approximate position of the current item in the list.
- A deeper band indicates fewer items.

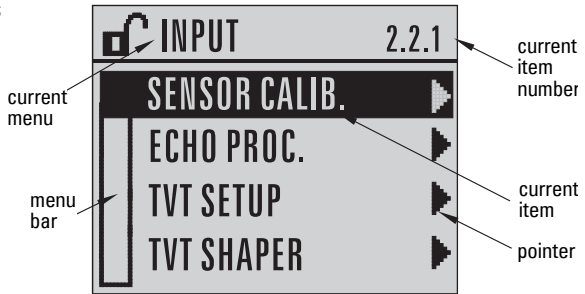

Parameter view

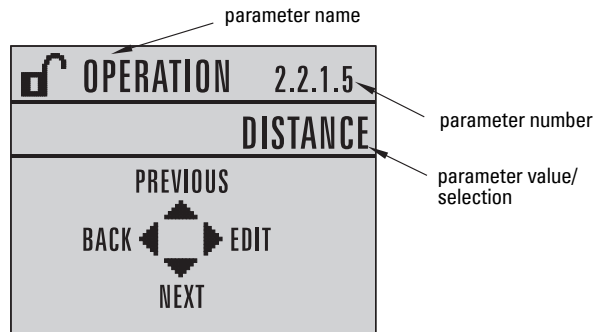

Edit view

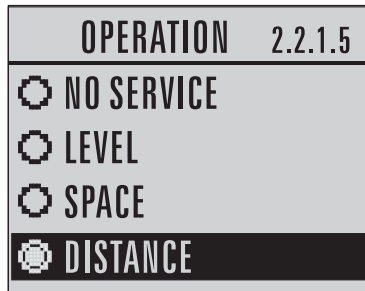

Handheld Programmer (Part No. 7ML1930-2AJ)

The programmer is ordered separately.



Key functions in Measurement mode

Key	Function	Result
	Updates the loop current.	New value is displayed in LCD secondary region.
	Updates internal enclosure temperature reading.	New value is displayed in LCD secondary region.
	Updates echo confidence value.	New value is displayed in LCD secondary region.
	Updates distance measurement.	New value is displayed in LCD secondary region.
	Mode opens PROGRAM mode.	Opens the menu level last displayed in this power cycle, unless power has been cycled since exiting PROGRAM mode or more than 30 minutes have elapsed since PROGRAM mode was used. Then top level menu will be displayed.
	RIGHT arrow opens PROGRAM mode.	Opens the top level menu.
	UP or DOWN arrow toggles between linear units and percent.	LCD displays measured value in either linear units or percent.

Programming SITRANS LR260

Notes:

- While the device is in PROGRAM mode, the output remains fixed and does not respond to changes in the device.
- Do not use the handheld programmer at the same time as SIMATIC PDM or erratic operation may result.
- SITRANS LR260 automatically returns to Measurement mode after a period of inactivity in PROGRAM mode (between 15 seconds and 10 minutes, depending on the menu level).

Change parameter settings and set operating conditions to suit your specific application.

- See *Operating via SIMATIC PDM* on page 36 for remote operation.

Programming via the handheld programmer

Parameter menus

Note: For the complete list of parameters with instructions, see *Parameter Reference* on page 49.

Parameters are identified by name and organized into function groups, then arranged in a 5-level menu structure (see *LCD menu structure* on page 121).

Note:

In Navigation mode **ARROW keys** move to the next menu item in the direction of the arrow.

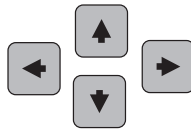

1. QUICK START

2. SETUP

2.1. DEVICE

2.2. INPUT

2.2.1. SENSOR CALIB.

2.2.4. ECHO PROC.

- For the complete list of parameters with instructions, see *Parameter Reference* on page 49.

1. Enter PROGRAM mode

- Point the programmer at the display (from a maximum distance of 500 mm [1.6 ft.]).

- **RIGHT arrow**  activates PROGRAM mode and opens menu level 1.



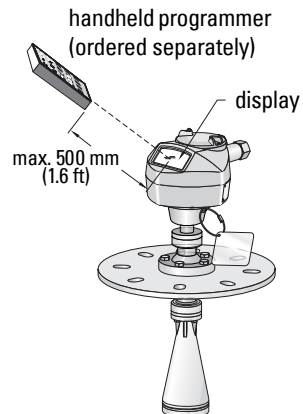



- **Mode**  opens the menu level last displayed in PROGRAM mode within the last 30 minutes, or menu level 1 if power has been cycled since then.



2. Navigating: key functions in Navigation mode



Notes:

- In Navigation mode, **ARROW keys** move to the next menu item in the direction of the arrow.
- For Quick Access to parameters via the handheld programmer, press Home , and then enter the menu number, for example: 2.2.1.

Key	Name	Menu level	Function
 	UP or DOWN arrow	menu or parameter	Scroll to previous or next menu or parameter.
	RIGHT arrow	menu	Go to first parameter in the selected menu, or open next menu.
		parameter	Open Edit mode.
	LEFT arrow	menu or parameter	Open parent menu.
	Mode	menu or parameter	Change to MEASUREMENT mode.
	Home	menu or parameter	Open top level menu: menu 1.

3. Editing in PROGRAM mode

Selecting a listed option

- Navigate to the desired parameter.
- Press **RIGHT arrow**  to open parameter view.
- Press **RIGHT arrow**  again to open **Edit** mode. The current selection is highlighted. Scroll to a new selection.
- Press **RIGHT arrow**  to accept it
The LCD returns to parameter view and displays the new selection.

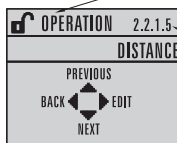

parameter name

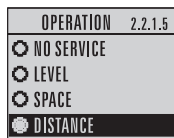

parameter number
current selection







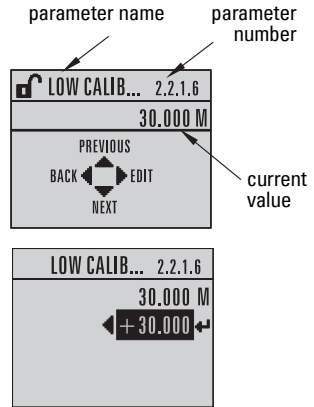



Changing a numeric value

- Navigate to the desired parameter.
- Press **RIGHT arrow**  to open parameter view. The current value is displayed.
- Press **RIGHT arrow**  again to open **Edit** mode. The current value is highlighted.
- Key in a new value.
- Press **RIGHT arrow**  to accept it. The LCD returns to parameter view and displays the new selection.



Key functions in Edit mode







Key	Name		Function
 	UP or DOWN arrow	Selecting options	Scrolls to item.
		Alpha-numeric editing	<ul style="list-style-type: none"> - Increments or decrements digits - Toggles plus and minus sign
	RIGHT arrow	Selecting options	<ul style="list-style-type: none"> - Accepts the data (writes the parameter) - Changes from Edit to Navigation mode
		Numeric editing	<ul style="list-style-type: none"> - Moves cursor one space to the right - or with cursor on Enter sign, accepts the data and changes from Edit to Navigation mode
	LEFT arrow:	Selecting options	<ul style="list-style-type: none"> - Cancels Edit mode without changing the parameter
		Numeric editing	<ul style="list-style-type: none"> - Moves cursor to plus/minus sign if this is the first key pressed - or moves cursor one space to the left. - or with cursor on Enter sign, cancels the entry
	Clear	Numeric editing	Erases the display.
	Decimal point	Numeric editing	Enters a decimal point.
	Plus or minus sign	Numeric editing	Changes the sign of the entered value.
 to 	Numeral	Numeric editing	Enters the corresponding character.

Quick Start Wizard via the handheld programmer

Notes:

- The Quick Start Wizard settings are inter-related and changes apply only after you click on **Yes** in **Apply?** at the end of the Quick Start steps.
- Do not use the Quick Start wizard to modify individual parameters: see instead *Parameter Reference* on page 49 (perform customization for your application only after the Quick Start has been completed).

1. Quick Start

- Point the programmer at the display (from a maximum distance of 500 mm [1.6 ft.]), then press **RIGHT arrow**  to activate PROGRAM mode and open menu level 1.
- Press **RIGHT arrow**  twice to navigate to menu item 1.1 and open parameter view.
- Press **RIGHT arrow**  to open **Edit** mode or **DOWN arrow**  to accept default values.
- To change a setting, scroll to the desired item or key in a new value.
- After modifying a value, press **RIGHT arrow**  to accept it and press **DOWN arrow**  to move to the next item.
- The Quick Start Wizard settings are inter-related and changes apply only after you click on **Yes** in **Apply?** at the end of the Quick Start steps.

1.1. Application Type

Options	STEEL	Silo construction
	CONCRETE	
	Default: STEEL	

1.2. Response Rate

Sets the reaction speed of the device to measurement changes in the target range.

Options	SLOW	0.1 m/minute
	MED	1.0 m/minute
	FAST	10.0 m/minute
	Default: FAST	

Use a setting just faster than the maximum filling or emptying rate (whichever is greater).

1.3. Units

Select the units for the Quick Start variables (high and low calibration point, and level, distance, or space)

Options	M, CM, MM, FT, IN Default: M
----------------	---------------------------------

1.4. Operation

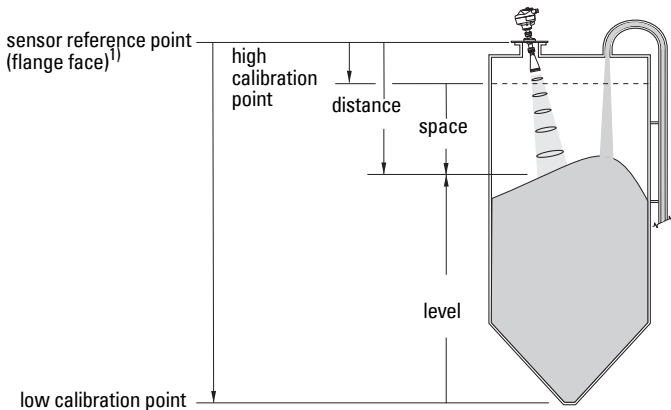

Operation types	NO SERVICE	SITRANS LR260 stops updating measurements and associated loop current. Last valid measurement is displayed.
	LEVEL	Distance to material surface referenced from Low Calibration Point (process empty level).
	SPACE	Distance to material surface referenced from High Calibration Point (process full level).
	DISTANCE	Distance to material surface referenced from Sensor Reference Point.
	Default: DISTANCE	

1.5. Low Calibration Point

Distance from Sensor Reference to Low Calibration Point: usually process empty level. (See 1.4. Operation for an illustration.)

Values	Range: 0.0000 to 30.000 m Default: horn type dependent
---------------	---

1.6. High Calibration Point

Distance from Sensor Reference to High Calibration Point: usually process full level. (See 1.4. Operation for an illustration.)

Values	Range: 0.0000 to 30.000 m Default: 0.0 m
---------------	---

1.7. Apply? (Apply changes)





In order to save the Quick Start settings it is necessary to select Yes to apply changes.

Options	YES, NO, DONE (Display shows DONE when Quick Start is successfully completed)
----------------	--

Press **Mode**  to return to Measurement mode. SITRANS LR260 is now ready to operate.

¹⁾ The point from which High and Low Calibration points are referenced: see *Dimensions*: on page 10.

Requesting an Echo Profile

- In PROGRAM mode, navigate to: **LEVEL METER > DIAGNOSTICS > ECHO PROFILE (3.1)**
- Press **RIGHT arrow**  to request a profile.
- In the Profile screen, press **UP arrow**  to select the **Transmit** icon, and **Right ARROW**  to update the profile.
- Press **DOWN arrow**  to select the **Exit** icon, then **Right ARROW**  to return to previous menu.

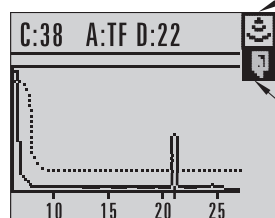
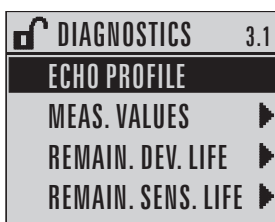

transmit icon,
deselected

exit icon,
selected



transmit icon,
selected



exit icon,
deselected

Device Address

The default address for the device is 0. To reset the address via the handheld programmer, see *Device Address* on page 80.

Auto False Echo Suppression

If SITRANS LR260 displays a false high level, or the reading is fluctuating between the correct level and a false high level, you can use the Auto False Echo Suppression parameters to prevent false echo detection. See *2.2.5. TVT (Auto False Echo Suppression) setup (TVT SETUP)* for instructions.

Level application example

The application is a steel silo containing flour that takes an average of 3 hours to fill and 3 weeks to empty.

Using the Easy Aimer, orient the LR260 so that the emission cone is approximately perpendicular to the material surface.

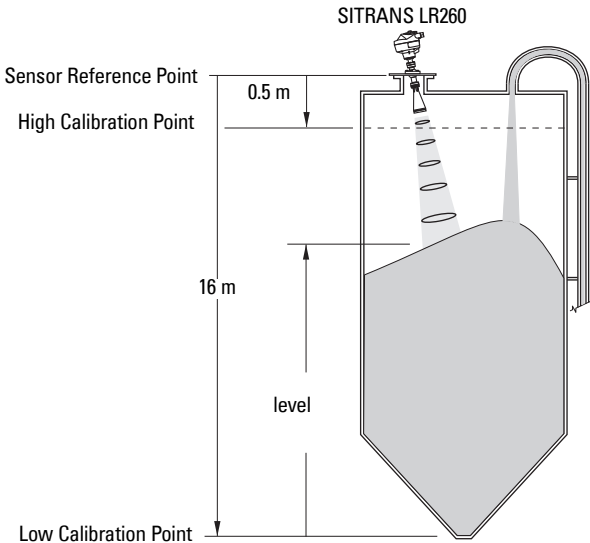

Quick Start Setting		Description
APPLICATION	STEEL	
RESPONSE RATE	SLOW	Response rate = 0.1 m/minute.
UNITS	m	
OPERATION	LEVEL	Material level referenced from Low Calibration Point.
LOW CALIBRATION POINT	16	Process empty level.
HIGH CALIBRATION POINT	0.5	Process full level.
APPLY? (CHANGES)	YES	Save new settings.

Fill rate = 0.09 m/minute (Low Cal Pt. minus High Cal Pt.) / fastest fill/empty time

= (16 m – 0.5 m) / 180 min.

= 15.5 m / 180 min. = 0.09 m/min.

Operating via SIMATIC PDM

Note: For a complete list of parameters with instructions, see *Parameter Reference* starting on page 49.

SIMATIC PDM is a software package used to commission and maintain SITRANS LR260 and other process devices. Please consult the operating instructions or online help for details on using SIMATIC PDM. (You can find more information at www.fielddevices.com: go to **Products and Solutions > Products and Systems > Communications and Software > Process Device Manager**.)

Functions in SIMATIC PDM

Notes:

- While the device is in PROGRAM MODE, the output remains fixed and does not respond to changes in the device.
- Do not use the handheld programmer at the same time as SIMATIC PDM, or erratic operation may result.

SIMATIC PDM monitors the process values, alarms and status signals of the device. It allows you to display, compare, adjust, verify, and simulate process device data.

For information on adjusting parameter values and viewing the results, see *Changing parameter settings using SIMATIC PDM* on page 41 and *Parameters accessed via pull-down menus* on page 41.

Features of SIMATIC PDM Rev. 6.0, SP3 (or higher)

The graphic interface in SITRANS LR260 makes monitoring and adjustments easy.

- The graphic Quick Start Wizard provides an easy 4-step guide to help you configure the device for a simple application. See *Quick Start Wizard via SIMATIC PDM* on page 37 for instructions.
- See *Display* on page 42 to monitor process variables.
- See *Echo profile* on page 42 for easy echo profile comparison.
- See *Trend* on page 43 for Level trend monitoring.
- See *Auto False Echo Suppression* on page 44 and *TVT Shaper* on page 45 on adjusting the TVT curve to avoid false echoes.
- See *Simulate AO (Analog Output)* on page 48 to simulate a process value during commissioning and maintenance.

Electronic Device Description (EDD)

Note: SITRANS LR260 requires the EDD for SIMATIC PDM version 6.0 with SP3 or higher.

You can locate the EDD in Device Catalog, under **Sensors/Level/Echo/Siemens Milltronics/SITRANS LR260**. Check the product page of our website at: www.siemens.com/LR260, under **Downloads**, to make sure you have the latest version of SIMATIC PDM, the most recent Service Pack (SP) and the most recent hot fix (HF). If you need to install a new EDD, see *Configuring a new device* below.

Configuring a new device

Note: Clicking on **Cancel** during an upload from device to SIMATIC PDM will result in some parameters being updated.

1. Check that you have the most recent EDD that applies to your device version, and if necessary download it from the product page listed above. Save the files to your computer, and extract the zipped file to an easily accessed location. Launch **SIMATIC PDM – Manage Device Catalog**, browse to the unzipped EDD file and select it.
2. Launch SIMATIC Manager and create a new project for LR260. Application Guides for setting up HART devices with SIMATIC PDM can be downloaded from the product page of our website at: www.siemens.com/LR260.
3. Upload parameters to the PC/PG.

Quick Start Wizard via SIMATIC PDM

The graphic Quick Start Wizard provides an easy 4-step guide to help you configure the device for a simple application.

Please consult the operating instructions or online help for details on using SIMATIC PDM.

1. If you have not already done so, check that you have the most up-to-date Electronic Device Description (EDD) for your instrument. (See *Configuring a new device* above.)
2. Launch SIMATIC Manager and create a new project for LR260. Application Guides for setting up HART devices with SIMATIC PDM can be downloaded from the product page of our website at: www.siemens.com/LR260.
3. Upload parameters to the PC/PG.
4. Configure the device via the Quick Start Wizard.

Quick Start

Notes:

- The Quick Start wizard settings are inter-related and changes apply only after you click on Transfer at the end of step 4.
- Do not use the Quick Start Wizard to modify individual parameters: see instead *Parameter Reference* on page 49. (Perform customization only after the Quick Start has been completed.)
- Initial Quick Start parameter values are not default values and do not necessarily reflect the current device configuration.
- Click on **BACK** to return and revise setting or **Cancel** to exit the Quick Start.

Launch SIMATIC PDM, open the menu **Device – Quick Start**, and follow steps 1 to 4.

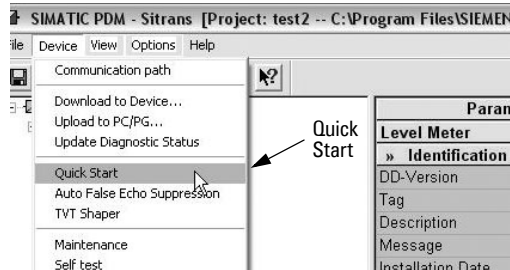

Step 1 – Identification

Note: The layout of the dialog boxes shown may vary according to the resolution setting for your computer monitor.

Click on **NEXT** to accept the default values. (Description, Message, and Installation Date fields can be left blank.)

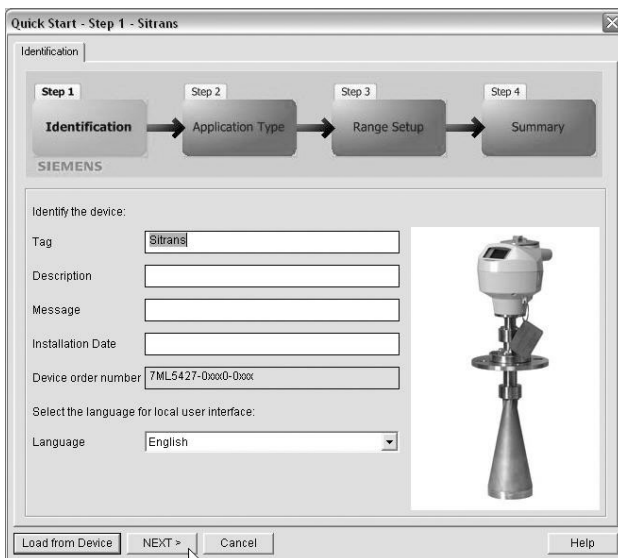

Step 2 – Application Type

Select the application type and the operation, then click on **NEXT**.

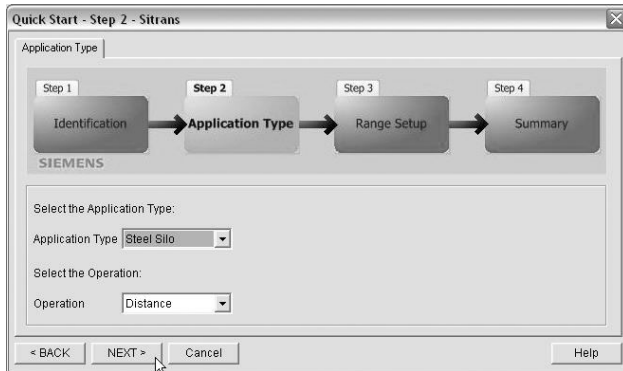

Step 3 – Range Setup

Set the parameters, and click on **NEXT**.

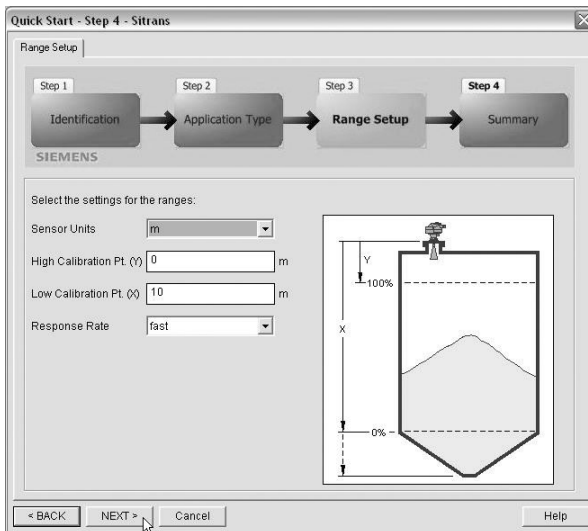

Step 4 – Summary

Check parameter settings, and click on **BACK** to return and revise values, or **TRANSFER** to transfer values to the device.

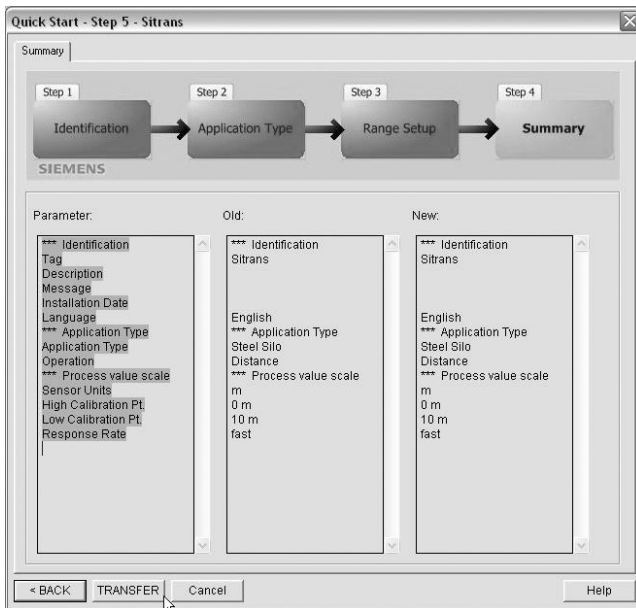

The message **Quick Start was successful** will appear. Click on **OK**, then click on **OK** again to synchronize with the device.

Changing parameter settings using SIMATIC PDM

Notes:

- For a complete list of parameters, see *Parameter Reference* on page 49.
- Clicking on **Cancel** during an upload from device to SIMATIC PDM will result in some parameters being updated.

1. Launch SIMATIC PDM, connect to SITRANS LR260, and upload data from the device.
2. Adjust parameter values in the parameter value field then press **Enter**. The status fields read **Changed**.
3. Open the Device menu, click on **Download to device**, then use **File – Save**, to save parameter settings. The status fields are cleared.

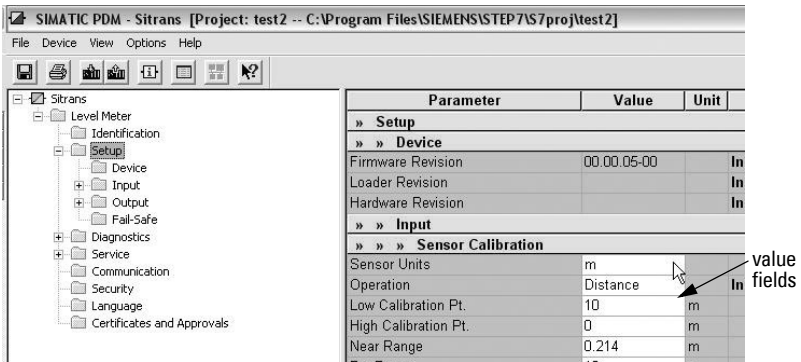

Parameters accessed via pull-down menus

You have access to a number of functions via pull-down menus from the menu bar under **Device** or **View**.

For a complete list see *Pull-down menus via SIMATIC PDM* on page 49.

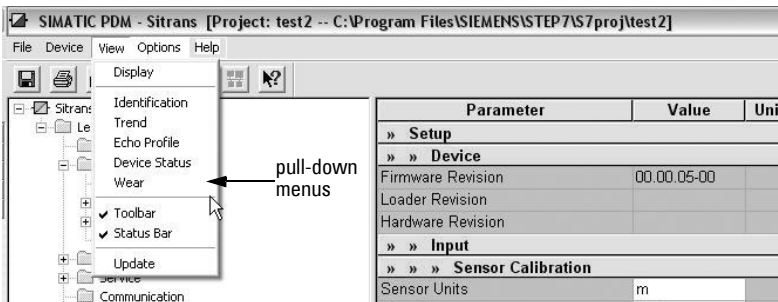

Display

To compare outputs in real time, open the menu **View – Display**.

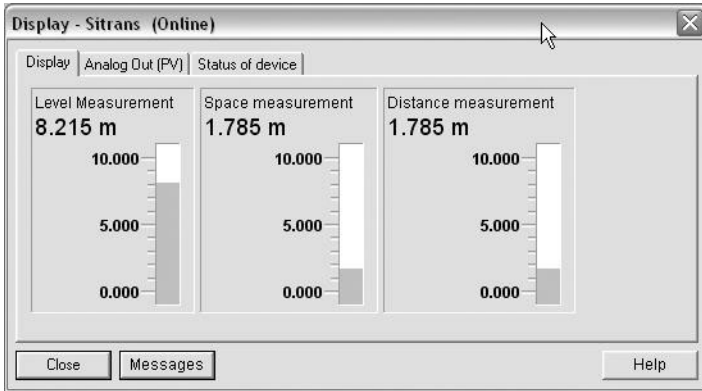

Echo profile

Notes:

- Double click on each axis and record the Xscale and Data Scale values, so that you can restore the default view by resetting to these values.
- You can save a profile or delete a saved profile.
- After saving a profile, open menu **View – Echo profile**.

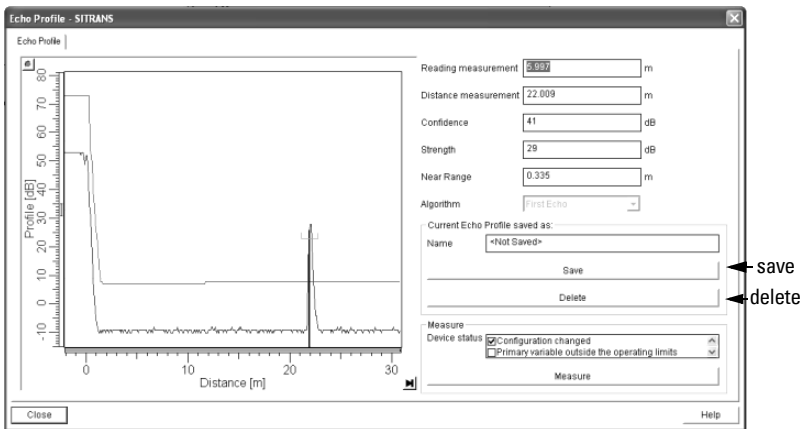

Trend

Notes:

- Double click on each axis and record the Xscale and Data Scale values, so that you can restore the default view by resetting to these values.

Open the menu **View – Trend**

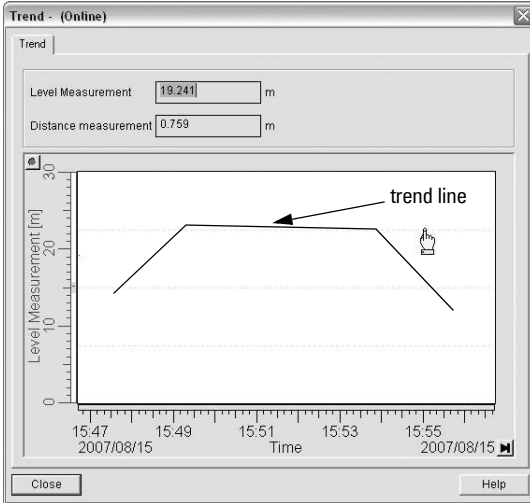

Auto False Echo Suppression

Notes:

- If possible, adjust Auto False Echo Suppression parameters with an empty or almost empty vessel.
- Set Auto False Echo Suppression and Auto Suppression Range during startup, if possible.
- Before adjusting these parameters, rotate the instrument for best signal (lower false-echo amplitude).

SITRANS LR260 first learns the echo profile. Then the learned profile, or part of it, is used to screen out false echoes. (See *Auto False Echo Suppression* on page 98 for a more detailed explanation.)

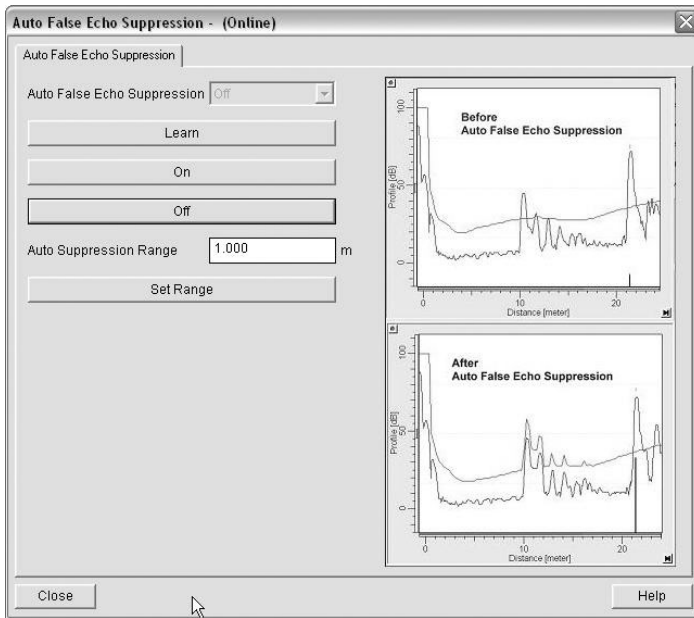

1. Determine Auto Suppression Range (the distance within which the learned TVT will replace the default TVT). Measure the actual distance from the antenna reference point to the material surface using a rope or tape measure, and make allowances for the actual location of the LR260. Subtract 2 m (6.56 ft) from this distance, and use the resulting value.
2. Open the menu **Device – Auto False Echo Suppression**.
3. Enter the value for **Auto Suppression Range** and click on **Set Range**.
4. Click on **Learn**. While the new curve is being learned, all buttons are inaccessible. Unless calculation is instantaneous, buttons will disappear until it is complete.
5. When buttons are visible, click on **Close**. Auto TVT is now on, and the learned TVT curve will be used.
6. To turn Auto False Echo Suppression off or on, reopen menu **Device – Auto False Echo Suppression** and click on **Off** or **On**.

TVT Shaper

Note: Double click on each axis and record the Xscale and Data Scale values, so that you can restore the default view by resetting to these values.

This feature allows you to manually adjust the TVT curve to avoid false echoes caused by obstructions. (For an explanation, see *Auto False Echo Suppression* on page 98.)

Open the menu **Device – TVT Shaper**

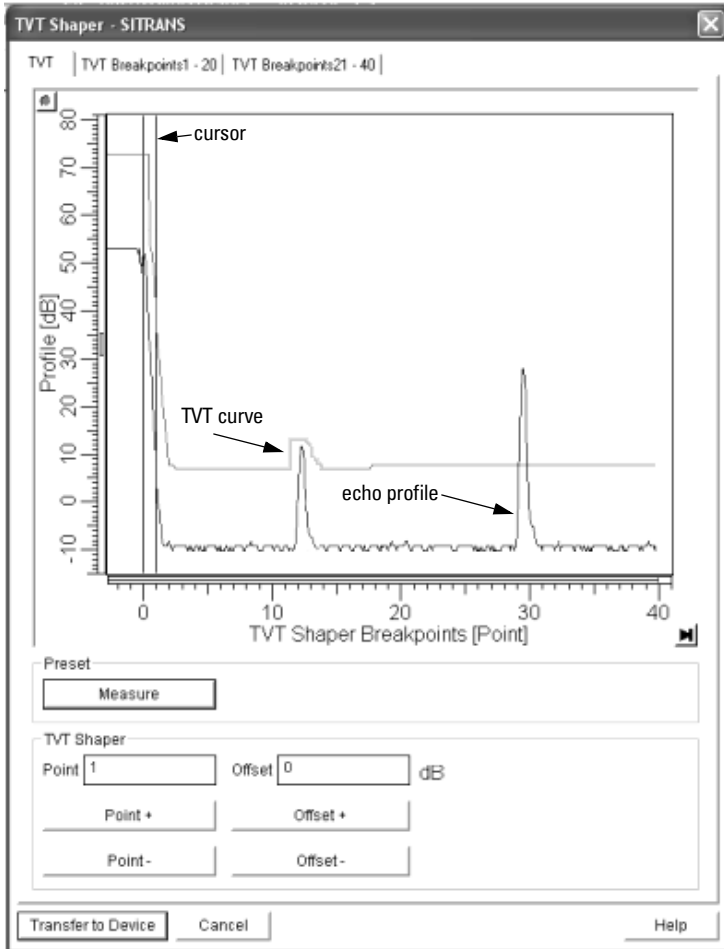

SIMATIC PDM

- Press **Measure** to refresh the echo profile and load the current TVT curve from the device.
- Change the position of the cursor on the TVT curve using the **Point+** and **Point-** buttons: raise and lower the curve using **Offset+** and **Offset-**.
- Alternatively, enter values for **Point** and **Offset** directly into the dialog boxes.
- Press **Transfer to Device**.

Device Status

Open the menu **View – Device Status** to view Device Status, Maintenance, and Diagnostics status.

- See *Diagnostics* on page 67.
- See *Remaining Device Lifetime (REMAIN. DEV. LIFE.)* on page 68 and *Remaining Sensor Lifetime (REMAIN SENS. LIFE.)* on page 71.

Wear

Open the menu **View – Wear** to view:

- Powered Days
- Power-on Resets

Maintenance

You can set schedules for:

- maintenance of the device based on its projected lifetime
- maintenance of the sensor based on its projected lifetime
- service
- calibration

To set Device/Sensor Maintenance schedules:

The screenshot shows a dialog box titled "Maintenance - SITRANS". It has four tabs: "Remaining Device Lifetime", "Remaining Sensor Lifetime", "Service Interval", and "Calibration Interval". The "Remaining Device Lifetime" tab is active. The dialog contains several input fields and buttons:

- Total Device Operating Time: 0.001 years
- Remaining Lifetime: 9.999 years
- Maintenance Required Limit: 0.164 years
- Maintenance Demanded Limit: 0.019 years
- Maintenance Alert Activation: Off (dropdown menu)
- Total Expected Device Life: 10.000 years
- Units: years (dropdown menu)
- Buttons: Read, Write, Snooze, OK, Cancel, Help

- 1) Open the menu **Device – Maintenance**, and click on the **Remaining Device/Sensor Lifetime** tab.
- 2) Modify desired values, and click on **Write**.
- 3) Click on **Read**, to see the effects of your modification.
- 4) If desired, activate alerts for either or both of **Maintenance Required/Maintenance Demanded**.
- 5) Click on **Snooze** to add a year to the Total Expected Device Life.

To set Service/Calibration schedules:

- 1) Open the menu **Device – Maintenance**, and click on the **Service/Calibration Schedule** tab.
- 2) Modify desired values, and click on **Write**.
- 3) Click on **Read**, to see the effects of your modification.
- 4) If desired, activate alerts.
- 5) Click on **Service Performed** to reset the schedule.

Device Reset

Factory Defaults

Use **Device Reset** to reset all user parameters excluding device addresses, the parameter block **Identification**, and Maintenance Schedule parameters to the default settings.

1. Open the menu **Device – Device Reset** and click on **OK** to perform a reset to Factory Defaults.
2. After the reset is complete, upload parameters to the PC/PG. (If you are performing a reset after replacing the device with a different instrument, do not upload parameters to the PC/PG).

Configuration Flag Reset

To reset the configuration flag to zero, open the menu **Device – Configuration Flag Reset** and execute a reset.

D/A (Digital/Analog) Trim

Allows you to trim the 4 mA and 20 mA points in order to calibrate the mA output.

Open the menu **Device – D/A Trim**. You will be prompted to attach a calibrated meter and enter the values at 4 mA and at 20 mA.

Select AnalogOut

Allows you to select one of three operation types:

- level
 - space
 - distance
- 1) Open the menu **Device – Select AnalogOut**.
 - 2) The **Select AnalogOut** window displays the current setting: click on **OK**.
 - 3) Select the desired option, and click on **OK**.
 - 4) The **Select AnalogOut** window displays the new setting: click on **OK**.

Simulate AO (Analog Output)

Allows you to input a simulated value in order to test the functioning of the mA connections during commissioning or maintenance of the device.

To simulate a user-defined mA value:

1. Open the menu **Device – Simulate AO**.
2. Select **Other**, enter the simulated value, and click on **OK**. The message 'Field Device fixed at new value' appears. Click on **OK**.
3. When you are ready to end simulation, select **End** and click on **OK** to return the device to the original output level.

HART Communication

Set the number of request/response preambles (minimum 5).



Open the menu **Device – HART Communication**.

How to Set Device Address

The default address for the device is **0**. To reset the address via the handheld programmer see *5.1.Device Address* on page 80.

Parameter Reference

Notes:

- See *Programming via the handheld programmer* on page 29 for detailed instructions.
- Do not use the handheld programmer at the same time as SIMATIC PDM, or erratic operation may result.
- **Mode**  toggles between **PROGRAM** and **Measurement Modes**.
- For Quick Access to parameters via the handheld programmer, press **Home** , then enter the menu number, for example: **2.2.1**.

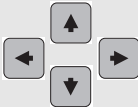

- In Navigation mode, **ARROWS** navigate the menu in the direction of the arrow.
- Press **RIGHT arrow** to open **Edit Mode**, or to save a modification.

Parameters are identified by name and organized into function groups. Menus arranged on up to five levels give access to associated features and options. (See *LCD menu structure* on page 121 for a chart.)

Parameters accessible via the handheld programmer are preceded by a number. Parameters not preceded by a number are accessible only via SIMATIC PDM.

Some parameters are accessible in SIMATIC PDM via pull-down menus (see below). Those parameters that can also be accessed via the handheld programmer are found in the numbered list. See also *LCD menu structure* on page 121.

Pull-down menus via SIMATIC PDM

Device menus	page	View menus	page
Communication path	-	Display	45
Download to device	-	Trend	43
Upload to PC/PG	-	Echo Profile	42
Update Diagnostic Status	-	Show Echo Profile ^{a)}	-
Quick Start	50	Wear (powered days/poweron resets)	46
Auto False Echo Suppression	44		
TVT shaper	45		
Maintenance	75 to 77	Toolbar	-
Device Reset	47	Status bar	-
Configuration Flag Reset	47		
Select AnalogOut	47		
D/A Trim	47		
Simulate AO	48		
HART Communication	48	Update	-

a) Visible only after an echo profile has been saved.

Quick Start Wizard

The Quick Start wizard groups together all the settings you need to configure for a simple application. You can access it either via SIMATIC PDM, or via the handheld programmer.

Do not use the Quick Start wizard to modify individual parameters (perform customization for your application only after the Quick Start has been completed).

1. Quick Start

1.1. Application Type

Options	STEEL	Silo construction
	CONCRETE	
	Default: STEEL	

1.2. Response Rate

Sets the reaction speed of the device to measurement changes in the target range.

Options	SLOW	0.1 m/minute
	MED	1.0 m/minute
	FAST	10.0m/minute
	Default: FAST	

Use a setting just faster than the maximum filling or emptying rate (whichever is greater). Slower settings provide higher accuracy; faster settings allow for more level fluctuation.

1.3. Units

Select the units for the Quick Start variables (high and low calibration point, and level, distance, or space).

Options	M, CM, MM, FT, IN Default: M
----------------	---------------------------------

1.4. Operation

Options	NO SERVICE	Stops updating measurements and associated loop current. Last valid measurement value is displayed.
	LEVEL	Distance to material surface referenced from Low Calibration Point (process empty level).
	SPACE	Distance to material surface referenced from High Calibration Point (process full level).
	DISTANCE	Distance to material surface referenced from Sensor Reference Point.
	Default: DISTANCE	

Operation types

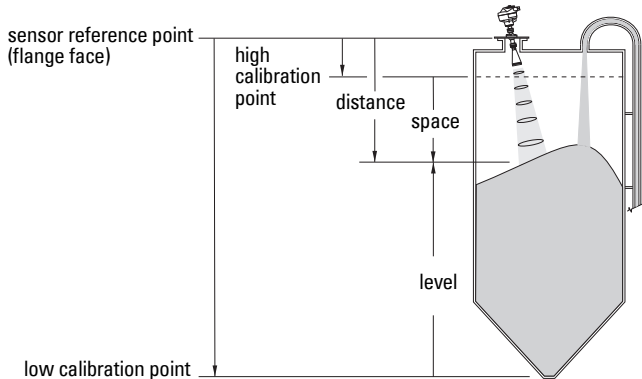

1.5. Low Calibration Point (LOW CALIB. PT.)

Distance from Sensor Reference to Low Calibration Point: usually process empty level. (See Operation types for an illustration.)

Values	Range: 0.0000 to 30.000 m Default: horn type dependent
---------------	---

1.6. High Calibration Point (HIGH CALIB. PT.)

Distance from Sensor Reference to High Calibration Point: usually process full level. (See Operation types for an illustration.)

Values	Range: 0.0000 to 30.000 m Default: 0.0 m
Related parameters	2.2.1.12. Near Range

When setting the High Calibration Point value, note that echoes are ignored within Near Range (2.2.1.11).

1.7. Apply? (Apply changes)

In order to save the Quick Start settings it is necessary to select Yes and apply changes.

Options	YES, NO, DONE Display shows DONE when Quick Start is successfully completed.
----------------	--

- Press **Mode**  to return to Measurement mode.

2. Setup

Notes:

- See *Programming via the handheld programmer* on page 29 or *Operating via SIMATIC PDM* on page 36 for instructions.
- Default settings in the parameter tables are indicated with an asterisk (*) unless explicitly stated.
- Values shown in the following tables can be entered via the handheld programmer.

2.1. Device

2.1.1. Firmware Revision (FIRMWARE REV.)

Corresponds to the software or firmware that is embedded in the SITRANS LR260. Read only.

2.1.2. Loader Revision (LOADER REV.)

Corresponds to the software used to update the SITRANS LR260. Read only.

2.1.3. Hardware Revision (HARDWARE REV.)

Corresponds to the electronics hardware of the SITRANS LR260. Read only.

2.2. Input

2.2.1. Sensor Calibration (SENSOR CALIB.)

You can configure each of the related parameters, to suit your particular application.

2.2.1.1. Antenna

Sets antenna type.

Values (view only)	No Horn, Horn 2, Horn 3, Horn 4
	Default is set by factory depending on horn size.

2.2.1.4. Sensor Units

Units the sensor is measuring in.

Values	M, CM, MM, FT, IN
	Default: M

2.2.1.5. Operation

Options	NO SERVICE	SITRANS LR260 stops updating measurements and associated loop current. Last valid measurement value is displayed.
	LEVEL	Distance to material surface referenced from Low Calibration Point (process empty level).
	SPACE	Distance to material surface referenced from High Calibration Point (process full level).
	* DIS-TANCE	Distance to material surface referenced from Sensor Reference Point.

Operation types

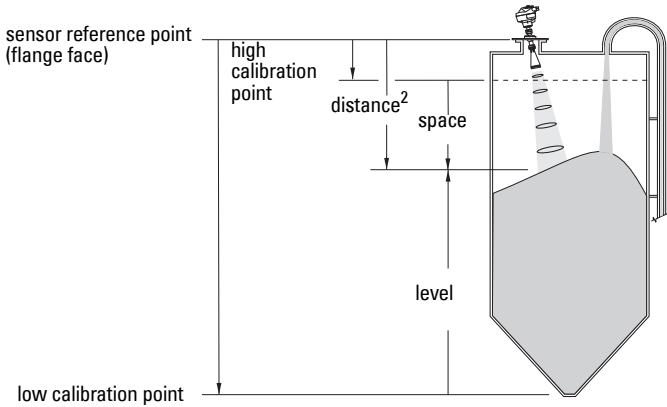

2.2.1.6. Low Calibration Pt. (LOW CALIB. PT.)

Distance from Sensor Reference to Low Calibration Point (corresponding to Low Level Point). Units are defined in Sensor Units.

SITRANS LR260 with Easy Aimer

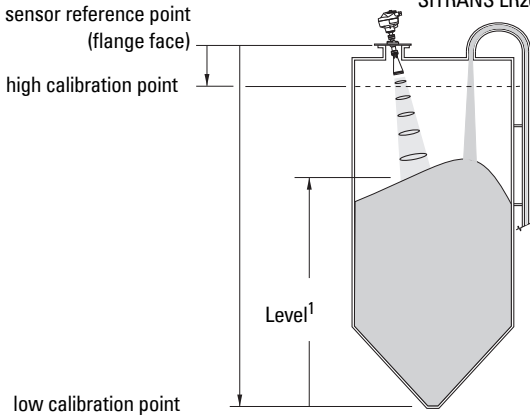

Values	Range: 0 to 30 m. Default dependent on horn type
---------------	---

2.2.1.7. High Calibration Pt. (HIGH CALIB. PT.)

Distance from Sensor Reference to High Calibration Point (corresponding to High Level Point). Units are defined in Sensor Units. (See Operation types for an illustration.)

Values	Range: 0 to 30 m. Default 0 m
Related parameters	2.2.1.12. Near Range

When setting the High Calibration Point value, note that echoes are ignored within Near Range (2.2.1.11).

- 1) The point from which level measurement is referenced. See *Dimensions:* on page 10.
- 2) The distance from sensor reference point to the target.

2.2.1.8. Limit Sensor Value

When On, limits the sensor value to the range between Low Calibration Point and High Calibration Point.

Options	ON, OFF. Default: On
----------------	----------------------

2.2.1.12. Near Range

The range in front of the device (measured from the sensor reference point) within which any echoes will be ignored, defined in sensor units. This is sometimes referred to as blanking or a dead zone. The factory setting is 50 mm past the end of the horn and the range is dependent on the horn type and any extensions.

		Factory Defaults	
Values	2" horn	0.21 m (8.43")	
	3" horn	0.28 m (10.95")	
	4" horn	0.34 m (13.19")	
	Range: 0 to 30 m		

2.2.1.13. Far Range

Allows the material level to drop below Low Calibration Point without generating a Loss of Echo (LOE) state. Unit is defined in Sensor units. See 2.2.1.5. Operation for an illustration.

Options	Range: 5 to 31.5 m
	Min. = Low Calibration Pt.
	Max. for 2" horn = 13 m (42.65 ft)
	Max. for 3" horn = 23 m (75.46 ft)
	Max. for 4" horn = 31 m (103.35 ft)
Default: Value for Low Calibration Pt. + 1 m (3.28 ft)	

Use this feature if the measured surface can drop below the Low Cal. Point in normal operation.

2.2.1.25. Sensor Offset

A constant offset that can be added to Sensor value¹⁾ to compensate if the sensor has been changed. Units are defined in Sensor Units.

Values	Range: -99 999 to 99 999
	Default: 0 m

¹⁾ The value produced by the echo processing which represents the distance from the sensor reference point to the target.

2.2.4. Echo Processing (ECHO PROC.)

2.2.4.1. Echo select

2.2.4.1.1. Algorithm

Selects the algorithm to be applied to the echo profile to extract the true echo.

Options	ALF	Area Largest First
	A	Echo Area
	L	Largest Echo
	F	First echo
	AL	Area Largest
	AF	Area First
	LF	Largest First
	BLF	Best of Largest or First echo
	BL	Best Largest
	BF	Best First
	L	Last echo
*	TF	True First

2.2.4.1.2. Echo Position

Defines where on the echo the distance measurement is determined. (See Echo Position Detection on page 97 for more details.)

Options		Rising Edge
	*	Center of Mass (COM)
		Hybrid (Center and CLEF)
		CLEF (Constrained Leading Edge Fit)

2.2.4.1.3. Echo Threshold

Sets the minimum echo confidence that the echo must meet in order to prevent a Loss of Echo condition and the expiration of the LOE timer. When Echo Confidence exceeds the Echo Threshold, the echo is accepted as a valid echo and is evaluated.

Values	Range: 0 to 99 dB
	Default: 5
Related Parameters	<i>2.4.1. Fail-safe Timer</i>

Use this feature when an incorrect material level is reported.

2.2.4.1.5. Echo Marker

The point on the selected echo from which the measured value is taken.

Values	Range: 5 to 95%
	Default: 70%
Related Parameters	<i>2.2.4.1.2. Echo Position</i>

When SITRANS LR260 is using Rising Edge, higher values will cause lower level readings and lower values will cause higher level readings.

2.2.4.2. Sampling

Provides a method of checking the reliability of a new echo before accepting it as the valid reading, based on numbers of samples above or below the currently selected echo.

2.2.4.2.1. Echo Lock

Selects the measurement verification process.

Options		Lock Off
	*	Maximum Verification
		Material Agitator
		Total Lock (not recommended for radar)
Related parameters	2.2.7.2. Fill Rate (FILL RATE/MIN) 2.2.7.3. Empty rate (EMPTY RATE/MIN) 2.2.4.2.4. Up Sampling 2.2.4.2.5. Down Sampling 2.2.4.2.6. Window	

2.2.4.2.4. Up Sampling

Specifies the number of consecutive echoes that must appear above the echo currently selected, before the measurement is accepted as valid.

Values	Range: 1 to 50
	Default: 5

2.2.4.2.5. Down Sampling

Specifies the number of consecutive echoes that must appear below the echo currently selected, before the measurement is accepted as valid.

Values	Range: 1 to 50
	Default: 5

2.2.4.2.6. Window

A "distance window" centered on the echo¹⁾, used to derive the reading. When a new measurement is in the window, the window is re-centered and the reading is calculated.

Values	Range: 0 to 30 m
	Default: 0

When the value is 0, the window is automatically calculated after each measurement.

- For slower Measurement Response values, the window is narrow.
- For faster Measurement Response values, the window becomes progressively wider.

Note: The echo lock window is stored as standard sample, but displayed in sensor units. Any value entered for the echo lock window will be rounded to the nearest sample.

2.2.4.3. Filtering

2.2.4.3.2. Damping Filter

The time constant for the damping filter. The damping filter smooths out the response to a sudden change in level. This is an exponential filter and the engineering unit is always in seconds. See Damping on page 100 for more detail.

Values	Range: 0 to 1000 s
	Default: 0 s

2.2.4.3.6. Narrow Echo Filter

Filters out echoes of a specific width.

Values	Range: 0 to 255
	0 = OFF
	greater = wider
Related parameters	Echo Confidence Long 2.2.4.3.7. Reform Echo

To remove a false echo from the Echo Profile, take its width in mm and multiply it by 0.013. Enter the result.

For example, to filter out a spike with 500 mm width, enter 6 or 7 (the closest integer product of 500×0.013).

When a value is keyed in, the nearest acceptable value is entered.

¹⁾ See *Echo Lock* on page 97 for more detail.

2.2.4.3.7. Reform Echo

Smooths jagged peaks in the echo profile. Reforms fragmented echoes into one echo.

Values	0 = OFF
	greater = wider Range: 0 to 50 mS Recommended: 5 to 20 mS; higher is not recommended.
Related parameters	2.2.4.1.1. Algorithm 2.2.4.3.6. Narrow Echo Filter 2.2.4.1.5. Echo Marker

2.2.4.5. Noise

2.2.4.5.1. Echo Confidence

Indicates echo reliability. It displays the echo confidence of the last measurement. Echo Threshold defines the Echo Confidence minimum criterion for echo confidence. Echo confidence must be greater than Echo Threshold to be accepted as valid and evaluated for an echo.

Values (view only)	0 to 99 dB	
	----	Shot not used
Related Parameters	2.2.4.1.3. Echo Threshold	

In PDM, open the menu **View – Echo Profile**.

2.2.4.5.2. Echo Strength

Displays the absolute strength (in dB above 1 μ V rms) of the echo selected as the measurement echo.

Values (view only)	-20 to 99 dB
---------------------------	--------------

In PDM, open the menu **View – Echo Profile**.

2.2.4.5.3. Noise Average

Displays the average ambient noise (in dB above 1 μ V rms) of a noise profile (view only). Noise level is a combination of transient noise and receiving circuitry. After a measurement, the values from the previous noise shot will be displayed.

2.2.5. TVT (Auto False Echo Suppression) setup (TVT SETUP)

First SITRANS LR260 learns the echo profile. Then the learned profile, or part of the learned profile, is used to screen out false echoes. See *Before and After Auto False Echo Suppression* on page 60 for examples.

2.2.5.1. TVT Hover Level

Defines how high the TVT (Time Varying Threshold) curve is placed above the noise floor of the echo profile, as a percentage of the difference between the peak of the largest echo in the profile and the noise floor. When SITRANS LR260 is located in the center of the vessel, the TVT hover level may be lowered to increase the confidence level of the largest echo. (For an illustration of the TVT curve see *Before Auto False Echo Suppression* on page 60.)

Values	Range: 0 to 100%
	Default: 33%

2.2.5.2. Auto False Echo Suppression

Enables a 'learned' TVT curve to be used in place of the default TVT curve. (See *Auto False Echo Suppression* on page 98 for an explanation)

Notes:

- If possible adjust Auto False Echo Suppression parameters with an empty or almost empty vessel.
- Set Auto False Echo Suppression and Auto False Echo Range during startup, if possible.

Options	OFF	Default TVT curve will be used.
	* ON	'Learned' TVT curve will be used.
	LEARN	'Learn' the TVT curve.

- Determine **Range** (the distance within which the learned TVT will replace the default TVT). Measure the actual distance from the sensor reference point to the material surface using a rope or tape measure, and make allowances for the actual location of the device.
- Subtract 2 m (6.56 ft) from this distance, and use the resulting value.

To use Auto False Echo Suppression via SIMATIC PDM:

- Open the menu **Device – Auto False Echo Suppression** and set Range. For more detail see *Auto False Echo Suppression* on page 44.
- Select **Learn**. The device will automatically revert to On (Use Learned TVT) after a few seconds.

To set Auto False Echo Suppression via the handheld programmer:

- Go to 2.2.5.3. *Auto Suppression Range* and enter new value.
- Go to 2.2.5.2. *Auto False Echo Suppression*. Press **RIGHT ARROW** to open Edit Mode
- Select **Learn**. The device will automatically revert to On (Use Learned TVT) after a few seconds.

Before Auto False Echo Suppression

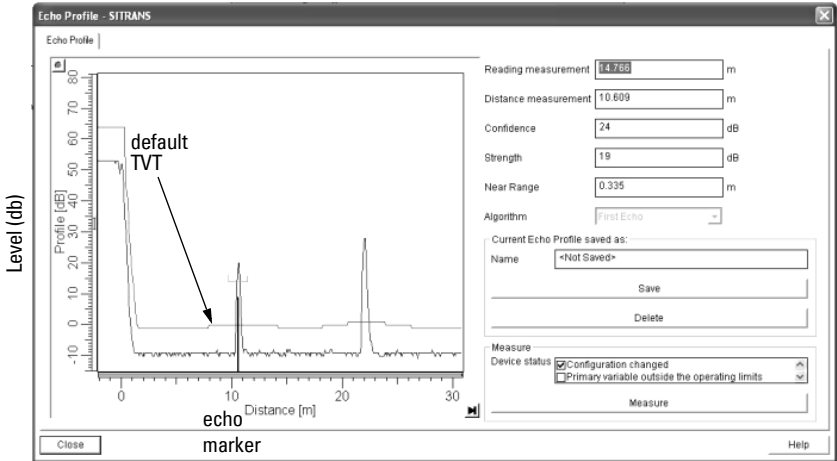

After Auto False Echo Suppression

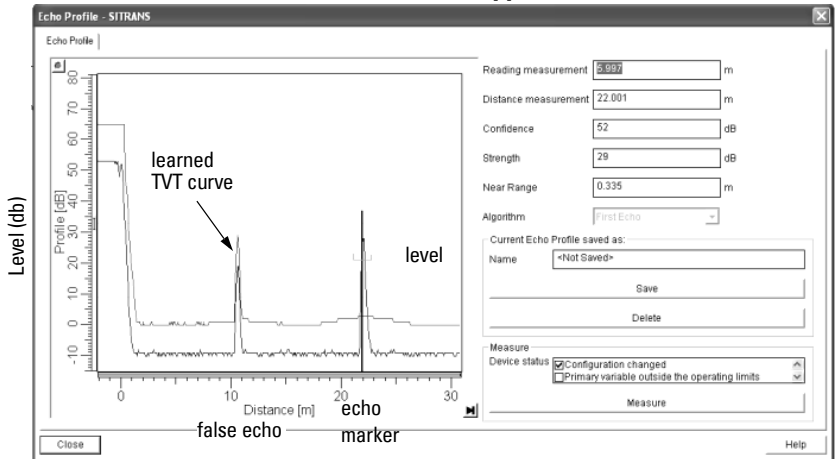

2.2.5.3. Auto Suppression Range

Defines the endpoint of the Learned TVT distance. Units are defined in sensor units.

Values	Range: 0.00 to 30.00 m
	Default: 1.00 m

- Press **RIGHT ARROW** to open Edit mode.
- Enter the new value and press **RIGHT ARROW** to accept it.
- Set 2.2.5.2. *Auto False Echo Suppression*.

2.2.5.4. Shaper Mode

Adjusts the TVT curve at a specified range.

Options		ON
	*	OFF

2.2.5.6. TVT Type

Selects the TVT shaping type to be applied to the echo profile to extract the true echo.

Options		Short Curved
		Short Flat
		Long Flat
		Long Smooth Front
		Long Smooth
		Slopes
	*	Long Smooth 2
		Short Curved 2

2.2.6. TVT shaper

A breakpoint on the TVT curve. This allows you to reshape the TVT curve to avoid unwanted echoes. There are 40 breakpoints arranged in five groups. To adjust the TVT curve after shape definition, see Shaper Mode on page 60.

2.2.6.1. Shaper 1-9

Values	Range: -50 to 50 dB
	Default: 0 dB

2.2.6.2. Shaper 10-18

Values	Range: -50 to 50 dB
	Default: 0 dB

2.2.6.3. Shaper 19-27

Values	Range: -50 to 50 dB
	Default: 0 dB

2.2.6.4. Shaper 28-36

Values	Range: -50 to 50 dB
	Default: 0 dB

2.2.6.5. Shaper 37-40

Values	Range: -50 to 50 dB
	Default: 0 dB

2.2.7. Rate

2.2.7.1. Response Rate

Note: Changing Response Rate resets Fill Rate, Empty Rate, Damping Filter and Echo Lock.

Sets the reaction speed of the device to measurement changes.

Related parameters	Response Rate	Fill Rate	Empty Rate	Damping Filter	Echo Lock
Options	slow	0.1 m/min.	0.1 m/min.	10 s	max. verifications
	medium	1 m/min.	1 m/min.	10 s	max. verifications
	* fast	10 m/min.	10 m/min.	0 s	max. verifications

Use a setting just faster than the maximum filling or emptying rate (whichever is faster).

2.2.7.2. Fill Rate (FILL RATE/MIN)

Defines the maximum rate at which the reported sensor value is allowed to increase. Allows you to adjust the SITRANS LR260 response to increases in the actual material level. Fill Rate is automatically updated whenever Response Rate is altered.

Values	Range: 0 to 30 m / min.
	Default: 10 m/min.
Altered by	Response Rate
Related parameters	Sensor Units

Enter a value slightly greater than the maximum vessel-filling rate, in Sensor Units per minute.

Options	Meters/Minute
Slow	0.1
Medium	1
Fast	10

2.2.7.3. Empty rate (EMPTY RATE/MIN)

Defines the maximum rate at which the reported sensor value is allowed to decrease. Adjusts the SITRANS LR260 response to decreases in the actual material level. Empty Rate is automatically updated whenever Response Rate is altered.

Values	Range: 0 to 30 m / min.
	Default: 10 m / min.
Altered by	Response Rate
Related	Sensor Units

Enter a value slightly greater than the vessel's maximum emptying rate, in Sensor Units per minute.

Options	Meters/Minute
Slow	0.1
Medium	1
Fast	10

2.2.8. Transducer Block (TB) Values

For diagnostic purposes

2.2.8.2. Level Measurement (LEVEL MEAS.)

The value for level. Read Only.

In SIMATIC PDM, open the menu **View – Display**, and select the tab **Display**.

2.2.8.3. Space Measurement (SPACE MEAS.)

The value for space. Read Only.

In SIMATIC PDM, open the menu **View – Display**, and select the tab **Display**.

2.2.8.4. Distance Measurement (DISTANCE MEAS.)

The value for distance. Read Only.

In SIMATIC PDM, open the menu **View – Display**, and select the tab **Display**.

2.3. Output

2.3.1. mA Output

2.3.1.1. mA Output Value

The loop current value in mA. Read Only except if the Manual option is chosen in mA Output function below (2.3.1.2).

Values	User Entry only if Manual option is chosen in 2.3.1.2. Range: 3.6 mA to 22.6 mA
---------------	--

2.3.1.2. mA Output Function (mA OUTPUT FUNC.)

Alters the mA output/measurement function and allows the output to be set independently.

Options	Manual
	Level
	Space
	* Distance

Notes:

- The mA Output Function is set independently from the setting in Operation. Set Operation first and then mA Output Function. (Operation resets mA Output Function to the same value.)
- The mA Output Function controls the primary value and the loop current for the SITRANS LR260. Use caution when changing the mA Output function when connected to a HART network.
- mA Output Function must be set to **Manual** before you can modify the mA Output Value (2.3.1.1). Remember to restore your previous setting after using mA Output Function.

2.3.1.3. 4 mA Setpoint

Sets the process level corresponding to the 4 mA value. 4 mA always defaults to 0, and mA Output Function determines whether this is a Level, Space, or Distance measurement. Level and Space are measured as a percentage of the difference between High Calibration Point and Low Calibration Point. Distance is measured as a percentage of the Low Calibration Point.

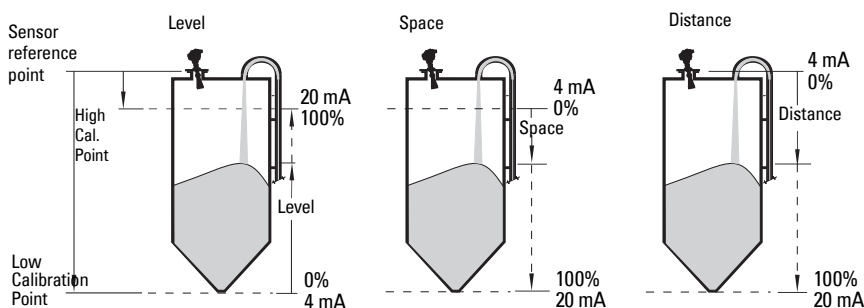

Values	Range: 0 to 30 m¹⁾
	Default: 0 m (set to value corresponding to 0% as defined by mA Output Function)
Related Parameters	mA Output Function

Enter the reading that is to correspond to a 4 mA output. Units are defined in Sensor units for Level, Space, or Distance.

¹⁾ 4 mA setpoint can be set less than 0 m, and 20 mA setpoint can be set greater than 30 m when using handheld programmer. Recommended range is 0 to 30 m.

2.3.1.4. 20 mA Setpoint

Sets the process level corresponding to the 20 mA value. 20 mA always defaults to 100%, and mA Output Function determines whether this is a Level, Space, or Distance measurement. Level and Space are measured as a percentage of the difference between High Calibration Point and Low Calibration Point; Distance is measured as a percentage of Low Calibration Point.

Values	Range: 0 to 30 m
	Default: 30 m (set to value corresponding to 100% as defined by mA Output Function)
Related Parameters	mA Output Function

Enter the reading that is to correspond to a 20 mA output. Units are defined in Sensor units for Level, Space, or Distance.

2.3.1.5. Minimum mA limit (MIN. mA LIMIT)

Prevents the mA output from dropping below this minimum level for a measurement value. This does not restrict the Fail-safe or manual settings.

Values	Range: 3.8 to 20.5 (mA)
	Default: 3.8 (mA)

2.3.1.6. Maximum mA limit (MAX. mA LIMIT)

Prevents the mA output from rising above this maximum level for a measurement value. This does not restrict the Fail-safe or manual settings.

Values	Range: 3.8 to 20.5 (mA)
	Default: 20.5 (mA)

2.3.1.7. 4 mA Output Trim

Calibrates the 4 mA output. The mA output of the device is pre-calibrated; however, 4 mA Output Trim can be used to trim remote displays or inputs.

Values	Range: 2.0 to 6.0 (mA)
Related parameters	20 mA Output Trim

Steps:

1. Set mA Output Function to Manual.
2. Set mA Output Value to 4 mA.
3. Attach a calibrated meter and check the output at the terminals; record the remote reading in mA.
4. Enter this value in 4 mA Output Trim.
5. Restore mA Output Function to previous setting.
6. Confirm that the mA output is as expected.

¹⁾ 4 mA setpoint can be set less than 0 m, and 20 mA setpoint can be set greater than 30 m when using handheld programmer. Recommended range is 0 to 30 m.

2.3.1.8. 20 mA Output Trim

Calibrates the 20 mA output. The mA output of the device is pre-calibrated; however, 20 mA Output Trim can be used to trim remote displays or inputs.

Values	Range: 18.0 to 24.0 (mA)
Related parameters	4 mA Output Trim

Steps:

1. Set mA Output Function to Manual.
2. Set mA Output Value to 20 mA.
3. Attach a calibrated meter and check the output at the terminals; record the remote reading in mA.
4. Enter this value in 20 mA Output Trim.
5. Restore mA Output Function to previous setting.
6. Confirm that the mA output is as expected.

2.4. Fail-safe

2.4.1. Fail-safe Timer

Sets the time to elapse in minutes since the last valid reading, before Fail-safe State activates.

Values	Range: 0 to 720 min.
	Default: 1

Note: The last valid reading is maintained until the Fail-safe timer expires. After the timer expires, the reading is set based on Fail-safe Material Level.

2.4.2. Fail-safe Material Level (FAILSAFE MAT. LE)

The material level to be reported when the Fail-safe Timer expires.

Options		HI: Use 22.6 mA (max. mA Limit) as material level
		LO: Use 3.6 mA (min. mA Limit) as material level
	*	HOLD: Level remains at last reading
		VALUE: User-selected value (defined in Fail-safe Level)

2.4.4. Fail-safe Level

Defines a user-defined level to report when the Fail-safe timer expires.

Values	Range: 3.6 mA to 22.6 mA
	Default: 22.6 mA

Note: This value can be used only if Fail-safe Material Level is set to VALUE.

3. Diagnostics

3.1. Echo Profile

Allows you to request the current echo profile either via the handheld programmer, or via SIMATIC PDM. (For more detail see Echo Processing on page 96.)

To request a profile via SIMATIC PDM:

- Open the menu **View – Echo Profile**.
- If desired, press **Save**.
- To view the saved profile, open the menu **View – Show Echo Profile**.

To request a profile via the handheld programmer:

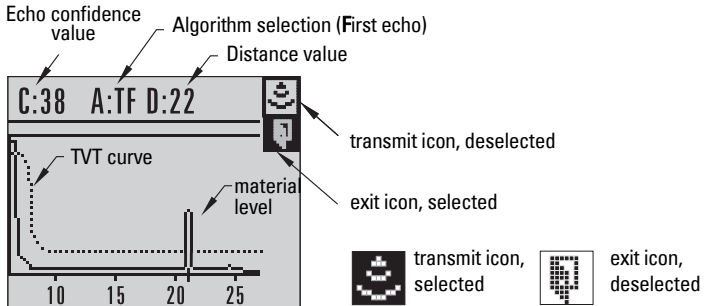

- In PROGRAM mode, navigate to **LEVEL METER > DIAGNOSTICS > ECHO PROFILE (3.1)**
- Press **RIGHT arrow** to request a profile.
- In the Profile screen, press **UP arrow** to select the **Transmit** icon, and **Right ARROW** to update the profile.
- Press **DOWN arrow** to select the **Exit** icon, then **Right ARROW** to return to previous menu.

3.14. Measured Values (MEAS. VALUES)

3.14.1. Current Internal Temperature (CURR. INTERN. TEMP.)

Read Only. Displays (in degrees C) the current temperature on the circuit board recorded by the internal electronics.

3.14.2. Maximum Internal Temperature (MAX. INTERN. TEMP.)

Read Only. Displays (in degrees C) the maximum temperature recorded by the internal electronics. The high and low values are maintained over a power cycle.

3.14.3. Minimum Internal Temperature (MIN. INTERN. TEMP.)

Read Only. Displays (in degrees C) the minimum temperature recorded by the internal electronics. The high and low values are maintained over a power cycle.

3.15. Remaining Device Lifetime (REMAIN. DEV. LIFE.)¹⁾

Notes:

- Four sets of parameters allow you to monitor the Device/Sensor Lifetimes and set up Maintenance/Service schedules, based on operating hours instead of a calendar-based schedule. See also **Remaining Sensor Lifetime, Service Interval, and Calibration Interval**.
- Performing a Device Reset to Factory Defaults using the handheld programmer will reset all the Maintenance Schedule parameters to their factory defaults.
- The device operates in years. To view Remaining Device Lifetime parameters in hours or days (via SIMATIC PDM only) see **Total Expected Device Life**.

The device tracks itself based on operating hours and monitors its predicted lifetime. You can modify the expected device lifetime, set up schedules for maintenance alerts, and acknowledge them.

The maintenance warnings and alarms are communicated to the end user through status information. This information can be integrated into any Asset Management system. For optimal use, we recommend that you use SIMATIC PCS7 Asset Management Software in conjunction with SIMATIC PDM.

To access these parameters via SIMATIC PDM:

- Open the menu **Device – Maintenance** and select the **Remaining Device Lifetime** tab.
- After modifying values/units as required, click on **Write** to accept the change, and **Read** to view the effect of the change.
- Click on **Snooze** to add a year to the Total Expected Device Life.

Parameter	Value	Unit
Total Device Operating Time	0.001	years
Remaining Lifetime	9.999	years
Maintenance Required Limit	0.164	years
Maintenance Demanded Limit	0.019	years
Maintenance Alert Activation	Off	
Total Expected Device Life	10.000	years
Units	years	

¹⁾ In device, Maintenance parameters are displayed in years. In SIMATIC PDM, maintenance parameter units are user selectable.

3.15.1. Total Device Operating Time (TOTAL OP. TIME)

Read only. The amount of time the device has been operating in selected units.

3.15.2. Remaining Device Lifetime (REMAIN. LIFETIME)

Read only. Remaining Lifetime in selected units.

3.15.3. Maintenance Required Limit (MAINT. REQ. LIMIT)

If the Remaining Lifetime is equal to or less than this limit, the device sets Maintenance Required.

Values	Range: 0 to 20 years
	Default: 0.164 years

In SIMATIC PDM, open the menu **Device – Maintenance**, click on **Remaining Device Lifetime**.

- Modify limit values as required.
- Enable 3.15.5. *Maintenance Alert Activation (ALERT ACTIVATION)*.

3.15.4. Maintenance Demanded Limit (MAINT. DEM. LIMIT)

If Remaining Device Lifetime is equal to or less than this limit, a Maintenance Demanded status is generated.

Values	Range: 0 to 20 years
	Default: 0.019 years

In SIMATIC PDM, open the menu **Device – Maintenance**, click on **Remaining Device Lifetime**.

- Modify limit values as required.
- Select the desired **Maintenance Alert Activation** option.

3.15.5. Maintenance Alert Activation (ALERT ACTIVATION)

Note: To modify this parameter via SIMATIC PDM it must be accessed via the pull-down menu **Device – Maintenance**.

Allows you to enable a maintenance limit.

Options	Warning Limit 1 (Maintenance Required Limit)
	Warning Limit 2 (Maintenance Demanded Limit)
	Warning Limits 1 and 2 (Maintenance Required and Maintenance Demanded Limits)
	* OFF

- First set the limit values in **Maintenance Required Limit (3.15.3.)**/**Maintenance Demanded Limit (3.15.4.)**.
- Select the desired **Maintenance Alert Activation** option.

3.15.6. Total Expected Device Life (TOTAL EXP. LIFE)

Note: The device always operates in years. Changing the units affects only the parameter view of the Remaining Device Lifetime parameters in SIMATIC PDM.

Allows you to override the factory default

Values	Units ^{a)} : hours, days, years
	Range: 0 to 20 years
	Default: 10 years

- a) Units are selectable only via SIMATIC PDM.

3.15.7. Maintenance Status (MAINT. STAT.)

Read only. Displays the status of the Maintenance limits.

In SIMATIC PDM, open the menu **View – Device Status**, click on the **Maintenance** tab and check the **Device Lifetime Status** window.

3.15.8. Acknowledge Status (ACK STATUS)

Read only. Displays the status of the Maintenance limits

In SIMATIC PDM, open the menu **View – Device Status**, click on the **Maintenance** tab and check the **Device Lifetime Status** window.

3.15.9. Acknowledge (ACK)

Acknowledges the current limit status

To acknowledge an alert via PDM:

- Open the menu **View – Device Status** and click on the tab **Maintenance**.
- In the Device Lifetime section, click on **Acknowledge Warnings**.

To acknowledge an alert via the handheld programmer:

- Press **RIGHT arrow** twice to open parameter view and activate **Edit Mode**.
- Press **RIGHT arrow** to acknowledge the alert.

3.16. Remaining Sensor Lifetime (REMAIN SENS. LIFE.)¹⁾

Notes:

- Four sets of parameters allow you to monitor the Device/Sensor Lifetimes and set up Maintenance/Service schedules, based on operating hours instead of a calendar-based schedule. See also **Remaining Device Lifetime**, **Service Interval**, and **Calibration Interval**.
- The device operates in years. To view Remaining Sensor Lifetime parameters in hours or days (via SIMATIC PDM only) see **Total Expected Sensor Life**.

The device monitors the predicted lifetime of the sensor (the components exposed to the vessel environment). You can modify the expected sensor lifetime, set up schedules for maintenance alerts, and acknowledge them.

To access these parameters via SIMATIC PDM:

- Open the menu **Device – Maintenance** and select the **Remaining Sensor Lifetime** tab.
- After modifying values/units as required, click on **Write** to accept the change, and **Read** to view the effect of the change.
- Click on **Snooze** to add a year to the Total Expected Sensor Life.
- Click on **Sensor Replaced** to restart the timer and clear any fault messages.

The screenshot shows the 'Maintenance - SITRANS' dialog box with the 'Remaining Sensor Lifetime' tab selected. The parameters are as follows:

Parameter	Value	Unit
Total Sensor Operating Time	0.000	years
Remaining Sensor Lifetime	10.000	years
Maintenance Required Limit	0.164	years
Maintenance Demanded Limit	0.019	years
Maintenance Alert Activation	Off	
Total Expected Sensor Life	10.000	years
Units	years	

Buttons at the bottom: Read, Write, Sensor Replaced, Snooze, OK, Cancel, Help.

3.16.1. Total Sensor Operating Time (SENS OP. TIME)

Displays the amount of time the sensor has been operating in selected units. Can be reset to zero after performing a service or replacing the sensor.

To reset to zero:

- In SIMATIC PDM, open the menu **Device – Maintenance**, click on the **Remaining Sensor Lifetime** tab, and click on **Sensor Replaced** to restart the timer and clear any fault messages.
- Via the handheld programmer, manually reset Total Sensor Operating Time to zero.

¹⁾ In device, Maintenance parameters are displayed in years. In SIMATIC PDM, maintenance parameter units are user selectable.

3.16.2. Remaining Sensor Lifetime (REMAIN. LIFETIME)

Read only. *Total Expected Sensor Life less Total Sensor Operating Time in selected units.*

3.16.3. Maintenance Required Limit (MAINT. REQ. LIMIT)

If Remaining Sensor Lifetime is equal to or less than this limit, the device sets Maintenance Required.

Values	Range: 0 to 20 years
	Default: 0.164 years

To modify the value via PDM, open the menu **Device – Maintenance** and click on **Remaining Sensor Lifetime**.

- Modify limit values as required.
- Enable *3.16.5. Maintenance Alert Activation (ALERT ACTIVATION)*. Click on **Write** to accept the changes.

3.16.4. Maintenance Demanded Limit (MAINT. DEM. LIMIT)

If Remaining Sensor Lifetime is equal to or less than this limit, the device sets Maintenance Demanded.

Values	Range: 0 to 20 years
	Default: 0.019 years

To modify the value via PDM, open the menu **Device – Maintenance** and click on **Remaining Sensor Lifetime**.

- Modify limit values as required.
- Enable *3.16.5. Maintenance Alert Activation (ALERT ACTIVATION)*. Click on **Write** to accept the changes.

3.16.5. Maintenance Alert Activation (ALERT ACTIVATION)

Note: To modify this parameter via SIMATIC PDM it must be accessed via the pull-down menu **Device – Maintenance**.

Allows you to enable a maintenance limit

Options		Warning Limit 1 (Maintenance Required Limit)
		Warning Limit 2 (Maintenance Demanded Limit)
		Warning Limits 1 and 2 (Maintenance Required and Maintenance Demanded Limits)
	*	OFF

- First set the limit values in **Maintenance Required Limit/Maintenance Demanded Limit**.
- Select the desired **Maintenance Alert Activation** option.

3.16.6. Total Expected Sensor Life (TOTAL. EXP. LIFE)

Allows you to override the factory default.

Values	Units ^{a)} : hours, days, years
	Range: 0 to 20 years
	Default: 10 years

a) Units are selectable only via SIMATIC PDM.

3.16.7. Maintenance Status (MAINT. STATUS)

Read only. Displays the status of the Maintenance limits

Via SIMATIC PDM, open the menu **View – Device Status**, click on the **Maintenance** tab and check the **Sensor Lifetime Status** window.

3.16.8. Acknowledge Status (ACK. STATUS)

Read only. Acknowledges the status of the Maintenance limits

Via SIMATIC PDM, open the menu **View – Device Status**, click on the **Maintenance** tab and check the **Sensor Lifetime Status** window.

3.16.9. Acknowledge (ACK.)

Acknowledges the current limit status.

To acknowledge an alert via SIMATIC PDM:

- Open the menu **View – Device Status** and click on the **Maintenance** tab.
- In the **Sensor Lifetime** section click on **Acknowledge Warnings**.

To acknowledge an alert via the handheld programmer:

- Press **RIGHT arrow** twice to open parameter view and activate **Edit Mode**.
- Press **RIGHT arrow** to acknowledge the alert.

4. Service

4.1. Device Reset

Resets all parameter to factory defaults, with the following exceptions:

- The Lock and Unlock values are not reset.
- The learned TVT curve is not lost.
- The device address is not reset.
- In PDM, the Identification parameters are not reset.

Note: Following a reset to factory defaults, complete reprogramming is required.

Options	*	Idle or Done (Return to previous menu)
		Factory Defaults

To perform a reset to factory defaults via SIMATIC PDM, open the menu **Device – Device Reset** and click on Factory Defaults.

4.2. Manufacture Date (MANUF. DATE)

The date of manufacture of the SITRANS LR260 (yy mm dd).

4.3. LCD Fast Mode

Note: Affects Measurement mode only; has no effect on Navigation mode.

Enables a faster rate of measurement from the device by disabling most of the display area. Only the bar graph will be refreshed when LCD Fast Mode is set to ON. When Fast Mode is set to ON, there is a delay of 30 minutes with no pressed buttons before actions result.

Values	ON or OFF Default: OFF
---------------	----------------------------------

4.4. LCD Contrast

The factory setting is for optimum visibility at room temperature and in average light conditions. Extremes of temperature will lessen the contrast.

Values	Range: 0 (High contrast) to 20 (Low contrast). Default: Matches factory calibration for best visual contrast.
---------------	--

Adjust the value to improve visibility in different temperatures and luminosity. Change the LCD contrast in small steps to ensure you can continue to read the display and to prevent viewing difficulties.

4.6. Powered Hours

Read only. Displays the number of hours the unit has been powered up since manufacture.

Via SIMATIC PDM, open the menu **View – Wear**. Time powered is displayed in user selectable units via PDM.

4.8. Power-on Resets

Read only. The number of power cycles that have occurred since manufacture.

Via SIMATIC PDM, open the menu **View – Wear**.

4.11. Memory Test (MEM. TEST)

Allows verification of the RAM, EEPROM, and Flash memory of the SITRANS LR260.

LCD Display	IDLE	No test in progress.
	BUSY	Test in progress.
	PASS	Memory test successful.
	FAIL	Test failed.
	Err1	Test returned unexpected results.
	P Oxcafe	Test passed with result data.
	F Oxcafe	Test failed with result data.
Handheld programmer entry	1 to 9	Any numeric key from 1 to 9 activates test.

Press any numeric key from 1 to 9 to activate the test. The reading will display BUSY followed by the test result text.

4.16. Service Interval¹⁾

Notes:

- Four sets of parameters allow you to monitor the Device/Sensor Lifetimes and set up Maintenance/Service schedules, based on operating hours instead of a calendar-based schedule. See also **Remaining Device Lifetime**, **Service Interval**, and **Calibration Interval**.
- The device operates in years. To view Remaining Sensor Lifetime parameters in hours or days (via SIMATIC PDM only) see **Total Expected Sensor Life**.

The device tracks service intervals based on operating hours and monitors the predicted lifetime to the next service. You can modify the Total Service Interval, set schedules for Maintenance Alerts, and acknowledge them.

The maintenance warnings and alarms are communicated to the end user through status information. This information can be integrated into any Asset Management system. For optimal use, we recommend that you use SIMATIC PCS7 Asset Management Software in conjunction with SIMATIC PDM.

To access these parameters via SIMATIC PDM:

- Open the menu **Device – Maintenance** and select the **Service Interval** tab.
- After modifying values/units as required, click on **Write** to accept the change, and **Read** to view the effect of the change.
- Click on **Service Performed** to restart the timer and clear any fault messages.

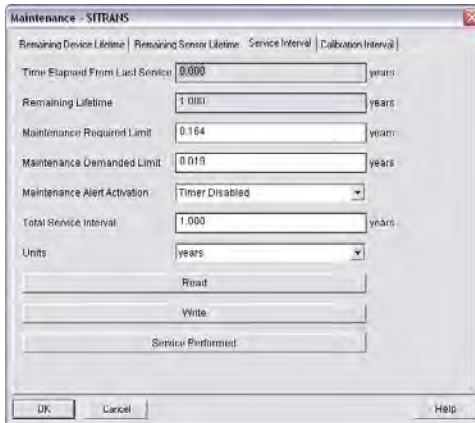

4.16.1. Time Last Serviced (TIME LAST SERV.)

Time elapsed since device was last serviced in selected units. Can be reset to zero via the handheld programmer (after performing a service.)

To reset to zero:

- In SIMATIC PDM, open the menu **Device – Maintenance**, click on the **Service Interval** tab, and click on **Service Performed** to restart the timer and clear any fault messages.
- Via the handheld programmer, manually reset **Time Last Serviced** to zero.

¹⁾ In device, Maintenance parameters are displayed in years. In SIMATIC PDM, maintenance parameter units are user selectable.

4.16.2. Remaining Lifetime (REMAIN LIFETIME)

Read only. **Total Service Interval** less **Time Last Serviced** in selected units.

4.16.3. Maintenance Required Limit (MAINT. REQ. LIMIT)

If **Remaining Lifetime** is equal to or less than this limit, the device sets **Maintenance Required**.

Values	Range: 0 to 20 years
	Default: 0.164 years

- Modify limit values as required.
- Set **Maintenance Alert Activation** to the desired option.

4.16.4. Maintenance Demanded Limit

If **Remaining Lifetime** is equal to or less than this limit, the device sets **Maintenance Demanded**.

Values	Range: 0 to 20 years
	Default: 0.019 years

- Modify limit values as required.
- Set **Maintenance Alert Activation** to the desired option.

4.16.5. Maintenance Alert Activation

Note: To modify this parameter via SIMATIC PDM it must be accessed via the pull-down menu **Device – Maintenance**.

Allows you to enable a maintenance limit.

Values	* Timer off
	On - no limits
	On - limit 1
	On - limits 1 and 2
	On - limit 2

- First set the limit values in **Maintenance Required Limit/Maintenance Demanded Limit**.
- Select the desired **Maintenance Alert Activation** option

4.16.6. Total Service Interval

Note: The device always operates in years. Changing the units affects only the parameter view of the Service Interval parameters in SIMATIC PDM.

User-configurable recommended time between product inspections

Values	Units ^{a)} : hours, days, years
	Range: 0 to 20 years
	Default: 1 year

- Units are selectable only via SIMATIC PDM.

4.16.7. Maintenance Status (MAINT. STAT)

Read only. Displays the status of the Maintenance limits.

Open the menu **View – Display Status**, click on the **Maintenance** tab and check the **Service Schedule Status** window.

4.16.8. Acknowledge Status (ACK. STATUS)

Read only. Acknowledges the current limit status.

Open the menu **View – Display Status**, click on the **Maintenance** tab and check the **Service Schedule Status** window.

4.16.9. Acknowledge (ACK.)

Acknowledges the current limit status.

To acknowledge an alert via SIMATIC PDM:

- a) Open the menu **View – Device Status** and click on the **Maintenance** tab.
- b) In the **Service Schedule Status** section click on **Acknowledge Warnings**.

To acknowledge an alert via the handheld programmer:

- a) Press **RIGHT arrow** twice to open parameter view and activate **Edit Mode**.
- b) Press **RIGHT arrow** to acknowledge the alert.

4.17. Calibration Interval (CALIB. INTERVAL)¹⁾

Notes:

- Four sets of parameters allow you to monitor the Device/Sensor Lifetimes and set up Maintenance/Service schedules, based on operating hours instead of a calendar-based schedule. See also **Remaining Device Lifetime**, **Service Interval**, and **Calibration Interval**.
- The device operates in years. To view Remaining Sensor Lifetime parameters in hours or days (via SIMATIC PDM only) see **Total Expected Sensor Life**.

The device tracks calibration intervals based on operating hours and monitors the predicted lifetime to the next calibration. You can modify the Total Calibration Interval, set schedules for Maintenance Alerts, and acknowledge them.

To access these parameters via SIMATIC PDM:

- Open the menu **Device – Maintenance** and select the **Calibration Interval** tab.
- After modifying values/units as required, click on **Write** to accept the change, and **Read** to view the effect of the change.

¹⁾ In device, Maintenance parameters are displayed in years. In SIMATIC PDM, maintenance parameter units are user selectable.

- Click on **Calibration Performed** to restart the timer and clear any fault messages.

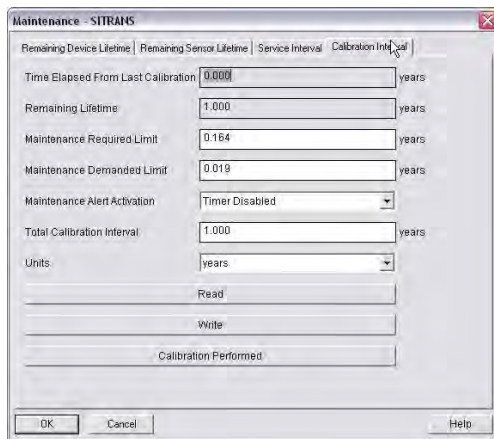

4.17.1. Time Last Calibrated (TIME LAST CAL.)

Time elapsed since last calibration Can be reset to zero via the handheld programmer (after performing a service).

To reset to zero:

- In SIMATIC PDM, open the menu **Device – Maintenance**, click on the **Calibration Interval** tab, and click on **Calibration Performed** to restart the timer and clear any fault messages.
- Via the handheld programmer, manually reset **Time Last Calibrated** to zero.

4.17.2. Remaining Lifetime (REMAIN LIFETIME)

Read only. Total Calibration Interval less Time Last Calibrated.

4.17.3. Maintenance Required Limit (MAINT. REQ. LIMIT)

If Remaining Lifetime is equal to or less than this limit, the device sets Maintenance Required.

Values	Range: 0 to 20 years
	Default: 0.164 years

- Modify limit values as required.
- Set **Maintenance Alert Activation** to the desired option.

4.17.4. Maintenance Demanded Limit (MAINT. DEM. LIMIT)

If Remaining Lifetime is equal to or less than this limit, the device sets Maintenance Demanded.

Values	Range: 0 to 20 years
	Default: 0.019 years

- Modify limit values as required.
- Set **Maintenance Alert Activation** to the desired option.

4.17.5. Maintenance Alert Activation

Note: To modify this parameter via SIMATIC PDM it must be accessed via the pull-down menu **Device – Maintenance**.

Allows you to enable a maintenance limit.

Values	*	Timer off
		On - no limits
		On - limit 1
		On - limits 1 and 2
		On - limit 2

- First set the limit values in **Maintenance Required Limit/Maintenance Demanded Limit**.
- Select the desired Alert Activation option.

4.17.6. Total Calibration Interval (TOTAL CALIB. INTRV.)

Note: The device always operates in years. Changing the units affects only the parameter view of the Calibration Interval parameters in SIMATIC PDM.

User-configurable recommended time between product calibrations.

Values	Units ^{a)} : hours, days, years
	Range: 0 to 20 years
	Default: 1 year

- Units are selectable only via SIMATIC PDM.

4.17.7. Maintenance Status (MAINT. STAT.)

Read only. Displays the status of the Maintenance Limits.

In SIMATIC PDM, open the menu **View – Device Status**, click on the **Maintenance** tab and check the **Calibration Schedule Status** window.

4.17.8. Acknowledge Status (ACK. STATUS)

Read only. Acknowledges the status of the Maintenance limits

In SIMATIC PDM, open the menu **View – Device Status**, click on the **Maintenance** tab and check the **Calibration Schedule Status** window.

4.17.9. Acknowledge (ACK.)

Acknowledges the current limit status.

To acknowledge an alert via SIMATIC PDM:

- Open the menu **View – Device Status** and click on the **Maintenance** tab.
- In the **Calibration Schedule Status** section, click on **Acknowledge Warnings**.

To acknowledge an alert via the handheld programmer:

- Press **RIGHT arrow** twice to open parameter view and activate **Edit Mode**.
- Press **RIGHT arrow** to acknowledge the alert.







5. Communication

5.1. Device Address

Sets the device address or poll ID on a HART network. Any address other than 0 will cause the output current to be a fixed value, and the current will not indicate the reading.

Values	Range: 0 to 15
	Default: 0

To set the address via the handheld programmer:

- Press **RIGHT arrow**  to activate **PROGRAM** mode and open menu level 1.
- Press **DOWN arrow**  repeatedly to navigate to **COMMUNICATION** (menu item 5).
- Press **RIGHT arrow**  to display the parameter list.
- Scroll to **DEVICE ADDRESS** and press **RIGHT arrow**  to open parameter view.
- Press **RIGHT arrow**  to open **Edit** mode. Key in a new value and press **RIGHT arrow**  to accept it.

5.2. Communication Control

Note: SITRANS LR260 can only reset this parameter via the handheld programmer.

Enables /disables the read/write access to parameters via remote communications.

Options		Read Only	No changes are permitted via remote communications.
	*	Read Write	Changes are permitted.
		Restricted	Sets the status to Read Only, with the potential for another HART device to change this via remote communications.

6. Security

6.1. Lock

Note:

- Do not lose this number value.
- This lock affects only the handheld programmer. A remote master can change configuration if **Communication Control** is set to allow this.

Prevents any changes to parameters via the handheld programmer.

Handheld programmer Values		Range: 1 to 9999	
	*	1954 (unlock value)	Off (enables local programming)
		Any other value	On (disables local programming)
Related parameter		Unlock value (6.2.)	

To secure the programming lock: Key in any value other than the unlock value. Parameters are now locked and cannot be changed.

To unlock the device and enable handheld programming changes: Key in the unlock value. Parameters are now unlocked and may be changed.

6.2. Unlock value

Notes:

- Default setting for 6.1 (Lock) is Unlocked.
- After a new value is stored in Unlock Value (6.2), that value will be recalled after a reset to Factory Defaults.
- Consult your Siemens Milltronics representative if you have forgotten the unlock value.

*Stores the value to be entered in **6.1. Lock** to unlock programming. If Lock is on, Unlock Value will not display the unlocked value*

Handheld programmer Values		Range: 1 to 9999	
		Factory Default: 1954	
	----		Display when Lock is on

7. Language

Selects the language to be used on the LCD.

Options	*	English
		German
		French
		Spanish

Appendix A: Alphabetical Parameter List

Note: Maintenance Parameters are not listed below. See *Remaining Device Lifetime (REMAIN. DEV. LIFE.)* on page 69, *Remaining Sensor Lifetime (REMAIN SENS. LIFE.)* on page 71, *Service Interval* on page 75, and *Calibration Interval (CALIB. INTERVAL)* on page 77 for those parameters.

Parameter Name (Parameter Number)	Page Number
<i>20 mA Output Trim</i> (2.3.1.8.)	66
<i>20 mA Setpoint</i> (2.3.1.4.)	65
<i>4 mA Output Trim</i> (2.3.1.7.)	65
<i>4 mA Setpoint</i> (2.3.1.3.)	64
<i>Algorithm</i> (2.2.4.1.1.)	55
<i>Application Type</i> (1.1.)	50
<i>Auto False Echo Suppression</i> (2.2.5.2.)	59
<i>Auto Suppression Range</i> (2.2.5.3.)	60
<i>Communication Control</i> (5.2.)	80
<i>Current Internal Temperature (CURR. INTERN. TEMP.)</i> (3.14.1.)	67
<i>Damping Filter</i> (2.2.4.3.2.)	57
<i>Device Address</i> (5.1.)	80
<i>Device Reset</i> (4.1.)	73
<i>Distance Measurement (DISTANCE MEAS.)</i> (2.2.8.4.)	63
<i>Down Sampling</i> (2.2.4.2.5.)	56
<i>Echo Confidence</i> (2.2.4.5.1.)	58
<i>Echo Lock</i> (2.2.4.2.1.)	56
<i>Echo Marker</i> (2.2.4.1.5.)	55
<i>Echo Profile</i> (3.1.)	67
<i>Echo Strength</i> (2.2.4.5.2.)	58
<i>Echo Threshold</i> (2.2.4.1.3.)	55
<i>Empty rate (EMPTY RATE/MIN)</i> (2.2.7.3.)	62
<i>Fail-safe Level</i> (2.4.4.)	66
<i>Fail-safe Material Level (FAILSAFE MAT. LE)</i> (2.4.2.)	66
<i>Fail-safe Timer</i> (2.4.1.)	66
<i>Far Range</i> (2.2.1.13.)	54
<i>Fill Rate (FILL RATE/MIN)</i> (2.2.7.2.)	62
<i>Firmware Revision (FIRMWARE REV.)</i> (2.1.1.)	52
<i>Hardware Revision (HARDWARE REV.)</i> (2.1.3.)	52

Parameter Name (Parameter Number)	Page Number
<i>High Calibration Pt. (HIGH CALIB. PT.)</i> (2.2.1.7.)	53
<i>Language</i> (7.)	81
<i>LCD Contrast</i> (4.4.)	74
<i>LCD Fast Mode</i> (4.3.)	74
<i>Level Measurement (LEVEL MEAS.)</i> (2.2.8.2.)	63
<i>Limit Sensor Value</i> (2.2.1.8.)	54
<i>Loader Revision (LOADER REV.)</i> (2.1.2.)	52
<i>Lock</i> (6.1.)	81
<i>Low Calibration Pt. (LOW CALIB. PT.)</i> (2.2.1.6.)	53
<i>mA Output Function (mA OUTPUT FUNC.)</i> (2.3.1.2.)	63
<i>mA Output Value</i> (2.3.1.1.)	63
<i>Manufacture Date (MANUF DATE)</i> (4.2.)	73
<i>Maximum Internal Temperature (MAX. INTERN. TEMP.)</i> (3.14.2.)	67
<i>Maximum mA limit (MAX. mA LIMIT)</i> (2.3.1.6.)	65
<i>Memory Test (MEM. TEST)</i> (4.11.)	74
<i>Minimum Internal Temperature (MIN. INTERN. TEMP.)</i> (3.14.3.)	68
<i>Minimum mA limit (MIN. mA LIMIT)</i> (2.3.1.5.)	65
<i>Narrow Echo Filter</i> (2.2.4.3.6.)	57
<i>Near Range</i> (2.2.1.12.)	54
<i>Noise</i> (2.2.4.5.)	58
<i>Noise Average</i> (2.2.4.5.3.)	58
<i>Operation</i> (2.2.1.5.)	52
<i>Echo Position</i> (2.2.4.1.2.)	55
<i>Powered Hours</i> (4.6.)	74
<i>Power-on Resets</i> (4.8.)	74
<i>Reform Echo</i> (2.2.4.3.7.)	58
<i>Response Rate</i> (2.2.7.1.)	62
<i>Sensor Offset</i> (2.2.1.25.)	54
<i>Sensor Units</i> (2.2.1.4.)	52
<i>Shaper Mode</i> (2.2.5.4.)	60
<i>Space Measurement (SPACE MEAS.)</i> (2.2.8.3.)	63
<i>For diagnostic purposes</i> ()	63
<i>TVT Hover Level</i> (2.2.5.1.)	59
<i>TVT Type</i> (2.2.5.6.)	61

Parameter Name (Parameter Number)	Page Number
<i>Unlock value</i> (6.2.)	81
<i>Up Sampling</i> (2.2.4.2.4.)	56
<i>Window</i> (2.2.4.2.6.)	57

Appendix B: Troubleshooting

Communication Troubleshooting













Generally:





1. Check the following:
 - There is power at the instrument
 - The LCD shows the relevant data you are expecting
 - The device can be programmed using the hand programmer
2. Verify that the wiring connections are correct.
3. Check that the device address is correctly set.
4. If you continue to experience problems, go to our website at:
• www.siemens.com/processautomation, and check the FAQs for SITRANS LR260, or contact your local Siemens Milltronics representative.

Specifically:

1. If you try to set a SITRANS LR260 parameter via remote communications, but the parameter remains unchanged:
 - Some parameters can only be changed when the device is not scanning. Try putting the device in PROGRAM mode using the operating mode function.
 - Try setting the parameter from the keypad. (First make sure that the lock parameter [6.1] is set to the unlock value.)
 - The communications control parameter 5.2 must be set to **Read/Write** to allow you to write parameters to SITRANS LR260.
2. If you see unanticipated displays, for example:
 - PROGRAM mode displayed instead of Measurement mode
 - the wrong parameter displayed in response to a command
 - a parameter displayed in response to no commandmake sure no infrared-capable device is close to SITRANS LR260. Any device with infrared capabilities (laptops, cell phones, PDAs) can cause interference which simulates a command to the SITRANS LR260, potentially causing it to switch modes or to change a parameter.
3. If the operation is erratic, make sure the Hand Programmer is not being used at the same time as SIMATIC PDM.

Device Status Icons



Icon	Priority Level	Meaning
	1	<ul style="list-style-type: none"> • Maintenance alarm • Measurement values are not valid
	2	<ul style="list-style-type: none"> • Maintenance warning: maintenance demanded immediately • Measured signal still valid
	3	<ul style="list-style-type: none"> • Maintenance required • Measured signal still valid
	1	<ul style="list-style-type: none"> • Process value has reached an alarm limit
	2	<ul style="list-style-type: none"> • Process value has reached a warning limit
	3	<ul style="list-style-type: none"> • Process value has reached a tolerance limit
	1	<ul style="list-style-type: none"> • Configuration error • Device will not work because one or more parameters/components is incorrectly configured
	2	<ul style="list-style-type: none"> • Configuration warning • Device can work but one or more parameters/components is incorrectly configured
	3	<ul style="list-style-type: none"> • Configuration changed • Device parameterization not consistent with parameterization in project. Look for info text.
	1	<ul style="list-style-type: none"> • Manual operation (local override) • Communication is good; device is in manual mode.
	2	<ul style="list-style-type: none"> • Simulation or substitute value • Communication is good; device is in simulation mode or works with substitute values.
	3	<ul style="list-style-type: none"> • Out of operation • Communication is good; device is out of action.

Icon	Priority Level	Meaning (Continued)
		<ul style="list-style-type: none"> Data exchanged
		<ul style="list-style-type: none"> No data exchange
		<ul style="list-style-type: none"> Write access enabled
		<ul style="list-style-type: none"> Write access disabled









General Fault Codes

Notes:









- If more than one fault is present, the device status indicator and text for each fault alternate at 2 second intervals.
- Some faults cause the device to go to Failsafe mode (Fault 52). These are indicated with an asterisk (*).

General Fault Codes			
Code / Icon		Meaning	Corrective Action
S: 0	*	The device was unable to get a measurement within the Fail-safe LOE Timer period. Possible causes: faulty installation, antenna material buildup, foaming/other adverse process conditions, invalid calibration range.	Ensure installation details are correct. Ensure no antenna material buildup. Clean if necessary. Adjust process conditions to minimize foam or other adverse conditions. Correct range calibration. If fault persists, contact your local Siemens representative.
			
S: 2	*	Unable to collect profile because of a power condition that is outside of the operating range of the device.	Repair required: contact your local Siemens representative.
			









General Fault Codes (Continued)

Code / Icon	Meaning	Corrective Action
S: 3 	Device is nearing its lifetime limit according to the value set in Maintenance Required Limit.	Replacement is recommended.
S: 4 	Device is nearing its lifetime limit according to the value set in Maintenance Demanded Limit.	Replacement is recommended.
S: 6 	Sensor is nearing its lifetime limit according to the value set in Maintenance Required Limit.	Replacement is recommended.
S: 7 	Sensor is nearing its lifetime limit according to the value set in Maintenance Demanded Limit.	Replacement is recommended.
S: 8 	Service interval as defined in Maintenance Required Limit has expired.	Perform service.
S: 9 	Service interval as defined in Maintenance Demanded Limit has expired.	Perform service.
S: 11 	Internal temperature sensor failure.	Repair required: contact your local Siemens representative.
S: 12 	Internal temperature of device has exceeded specifications: it is operating outside its temperature range.	Relocate device and/or lower process temperature enough to cool device. Inspect for heat-related damage and contact your local Siemens representative if repair is required. Fault code will persist until a manual reset is performed using PDM or the LCD interface.



General Fault Codes (Continued)

Code / Icon	Meaning	Corrective Action
S: 17 	Calibration interval as defined in Maintenance Required Limit has expired.	Perform calibration.
S: 18 	Calibration interval as defined in Maintenance Demanded Limit has expired.	Perform calibration.
S: 28 	* Internal device failure caused by a RAM memory error.	Repair required: contact your local Siemens representative.
S: 29 	* EEPROM damaged.	Repair required: contact your local Siemens representative.
S: 31 	* Flash error.	Repair required: contact your local Siemens representative.
S: 33 	* Factory calibration for the internal temperature sensor has been lost.	Repair required: contact your local Siemens representative.
S: 34 	* Factory calibration for the device has been lost.	Repair required: contact your local Siemens representative.
S: 35 	* Factory calibration for the device has been lost.	Repair required: contact your local Siemens representative.

General Fault Codes (Continued)





Code / Icon	Meaning	Corrective Action
S: 36 	* Unable to start microwave module.	Cycle power. If fault persists, contact your local Siemens representative.
S: 37 	* Measurement hardware problem.	Cycle power. If fault persists, contact your local Siemens representative.
S: 38 	* Microwave module hardware failure: unable to calculate distance measurement.	Cycle power. If fault persists, contact your local Siemens representative: repair required.
S: 43 	* Factory calibration for the radar receiver has been lost.	Repair required: contact your local Siemens representative.
S: 45 	* No valid boot program detected: firmware corrupt.	Repair required: contact your local Siemens representative.
S: 48 	* User configuration is invalid. One or more of parameters: Low Calibration Point, High Calibration Point, and/or Auto False-Echo Suppression, are set to invalid values.	Reconfigure the unit. Ensure the difference between High Calibration Point and Low Calibration Point is not less than or equal to zero; do a master reset.
S: 49 	* EEPROM corrupt.	Repair required: contact your local Siemens representative.
S: 50 	* EEPROM corrupt.	Repair required: contact your local Siemens representative.
S: 51 	* EEPROM corrupt.	Repair required: contact your local Siemens representative.

General Fault Codes (Continued)

Code / Icon	Meaning	Corrective Action
S: 52 	Fail-safe is activated. Possible causes: 1) hardware failure; 2) memory failure; 3) Fail-safe LOE timer expired – possible causes: faulty installation, antenna material buildup, foaming/other adverse process conditions, invalid calibration range.	For 3): Correct configuration; ensure installation is correct; no antenna material buildup; adjust process conditions to minimize foaming/other adverse conditions; correct calibration range. If fault persists, or for 1) and 2), contact your local Siemens representative.
S: 53 	* Configuration lost: one or more parameter settings have been lost. This may occur after a firmware upgrade causes user parameters to be reset.	Restore user parameters using SIMATIC PDM.

Operation Troubleshooting

Operating symptoms, probable causes, and resolutions.

Symptom	Cause	Action
Display shows  S: 0 LOE	level or target is out of range	<ul style="list-style-type: none"> • check specifications • check 2.2.1.6. <i>Low Calibration Pt. (LOW CALIB. PT.)</i> • increase 2.2.4.5.1. <i>Echo Confidence</i>
Display shows  S: 0 LOE	material build-up on antenna	<ul style="list-style-type: none"> • clean the antenna • re-locate SITRANS LR260
Display shows  S: 0 LOE	location or aiming: <ul style="list-style-type: none"> • poor installation • flange not level 	<ul style="list-style-type: none"> • check to ensure nozzle is vertical • use 2.2.5.2. <i>Auto False Echo Suppression</i> and check 2.2.5.3. <i>Auto Suppression Range</i> to ensure nozzle protrudes from end of vessel nozzle.
Display shows  S: 0 LOE	antenna malfunction: <ul style="list-style-type: none"> • temperature too high • physical damage 	<ul style="list-style-type: none"> • check 3.14.1. <i>Current Internal Temperature (CURR. INTERN. TEMP.)</i> • relocate

Symptom	Cause	Action (Continued)
Reading does not change, but the level does	SITRANS LR260 processing wrong echo, i.e. vessel wall, or structural member	<ul style="list-style-type: none"> re-locate SITRANS LR260 ensure nozzle protrudes 10 mm min. rotate instrument 90°. See <i>Orientation in a vessel with obstructions</i> on page 15. use 2.2.5.2. <i>Auto False Echo Suppression</i> and 2.2.5.3. <i>Auto Suppression Range</i>
Measurement is consistently off by a constant amount	<ul style="list-style-type: none"> setting for 2.2.1.6. <i>Low Calibration Pt. (LOW CALIB. PT.)</i> not correct setting for 2.2.1.25. <i>Sensor Offset</i> not correct 	<ul style="list-style-type: none"> check distance from sensor reference point to 2.2.1.6. <i>Low Calibration Pt. (LOW CALIB. PT.)</i> check 2.2.1.25. <i>Sensor Offset</i>
Screen blank	power error	<ul style="list-style-type: none"> check nameplate rating against voltage supply check power wiring or source
	too much load resistance	<ul style="list-style-type: none"> remove something from the loop, or increase supply voltage
Reading erratic	echo confidence weak	<ul style="list-style-type: none"> refer to 2.2.4.5.1. <i>Echo Confidence</i> use 2.2.5.2. <i>Auto False Echo Suppression</i> and 2.2.5.3. <i>Auto Suppression Range</i> use foam deflector or stillpipe
	material filling	<ul style="list-style-type: none"> re-locate SITRANS LR260
Reading response slow	2.2.7.2. <i>Fill Rate (FILL RATE/ MIN)</i> setting incorrect	<ul style="list-style-type: none"> increase measurement response if possible
Reads correctly but occasionally reads high when vessel is not full	<ul style="list-style-type: none"> detecting close range echo build up near top of vessel or nozzle nozzle problem 	<ul style="list-style-type: none"> clean the antenna use 2.2.5.2. <i>Auto False Echo Suppression</i> and 2.2.5.3. <i>Auto Suppression Range</i>
Level reading lower than material level	<ul style="list-style-type: none"> material is within Near Range zone multiple echoes processed 	<ul style="list-style-type: none"> decrease 2.2.1.12. <i>Near Range</i> (minimum value depends on antenna type) raise SITRANS LR260 ensure 2.2.4.1.1. <i>Algorithm</i> is set to F (First echo)

Appendix C: Maintenance

SITRANS LR260 requires no maintenance or cleaning under normal operating conditions.

Under severe operating conditions, the horn antenna may require periodic cleaning. If cleaning becomes necessary:

- Note the antenna material and the process medium, and select a cleaning solution that will not react adversely with either.
- Remove the instrument from service and wipe the antenna clean using a cloth and suitable cleaning solution.

Unit Repair and Excluded Liability

All changes and repairs must be done by qualified personnel, and applicable safety regulations must be followed. Please note the following:

- The user is responsible for all changes and repairs made to the device.
- All new components must be provided by Siemens Milltronics Process Instruments Inc.
- Restrict repair to faulty components only.
- Do not re-use faulty components.

Appendix D: Technical Reference

Principles of Operation

SITRANS LR260 is a 2-wire 25 GHz pulse radar level transmitter for continuous monitoring of solids and liquids¹⁾. Radar level measurement uses the time of flight principle to determine distance to a material surface. The device transmits a signal and waits for the return echo. The transit time is directly proportional to the distance from the material.

Pulse radar uses polarized electromagnetic waves. Microwave pulses are emitted from the antenna at a fixed repetition rate, and reflect off the interface between two materials with different dielectric constants (the atmosphere and the material being monitored).

Electromagnetic wave propagation is virtually unaffected by temperature or pressure changes, or by changes in the vapor levels inside a vessel. Electromagnetic waves are slightly attenuated by dust.

SITRANS LR260 consists of an enclosed electronic circuit coupled to an antenna and process connection. The electronic circuit generates a radar signal (25 GHz) that is directed to the horn.

The signal is emitted from the horn, and the reflected echoes are digitally converted to an echo profile. The profile is analyzed to determine the distance from the material surface to the sensor reference point. This distance is used as a basis for the display of material level and mA output.

Echo Processing

Process Intelligence

The signal processing technology embedded in Siemens radar level devices is known as **Process Intelligence**.

Process intelligence provides high measurement reliability regardless of the dynamically changing conditions within the vessel being monitored. The embedded Process Intelligence dynamically adjusts to the constantly changing material surfaces within these vessels.

Process Intelligence is able to differentiate between the true microwave reflections from the surface of the material and unwanted reflections being returned from obstructions such as seam welds or supports within a vessel. The result is repeatable, fast and reliable measurement. This technology was developed as result of field data gained over some twenty years from more than 1,000,000 installations in many industries around the world.

¹⁾ The microwave output level is significantly less than that emitted from cellular phones.

Higher order mathematical techniques and algorithms are used to provide intelligent processing of microwave reflection profiles. This “knowledge based” technique produces superior performance and reliability.

Time Varying Threshold (TVT) Curves

A Time Varying Threshold (TVT) curve hovers above the echo profile to screen out unwanted reflections (false echoes).

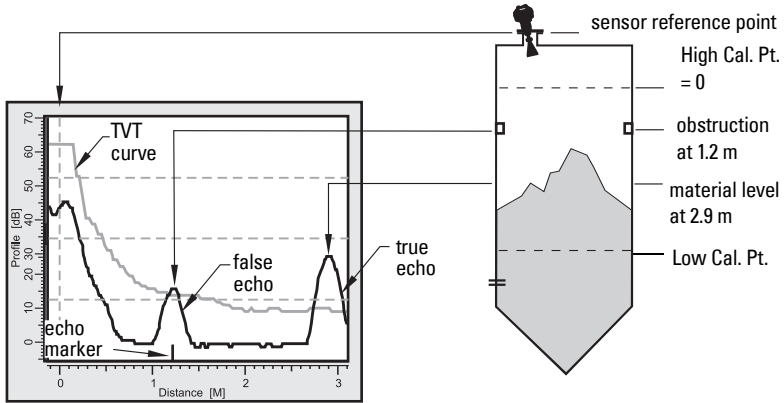

In most cases the material echo is the only one which rises above the default TVT curve. In a vessel with obstructions a large false echo may rise above the default TVT. The Auto False Echo Suppression feature (see below) can be used to screen it out.

The device characterizes all echoes that rise above the TVT as potential good echoes. Each peak is assigned a rating based on its strength, area, height above the TVT, amongst other characteristics.

The true echo is selected based on the setting for the Echo selection algorithm (2.2.4.11. *Algorithm*).

Echo Lock

If the echo selected by **Algorithm** is within the Echo Lock window, the window is centered about the echo, which is used to derive the measurement.

- **Lock Off:**
SITRANS LR260 responds immediately to a new selected echo (within the restrictions set by the Maximum Fill / Empty Rate), but measurement reliability is affected.

Echo Position Detection

The echo position algorithm (2.2.4.12. *Echo Position*) determines which point on the echo will be used to calculate the precise time of flight, and calculates the range using the calibrated propagation velocity (adjusted by a propagation factor, if necessary).

The options are **Center**, **CLEF** (Constrained Leading Edge Fit), **Hybrid** or **Rising Edge**. **CLEF** uses the leading edge of the echo. It can be used to compensate for materials with a low dK value, which may cause the vessel bottom to be reported as the level instead of the actual material level, in low level conditions. **CLEF range** is the level below which the CLEF algorithm will be used: above this level the Center algorithm is used.

Hybrid uses a combination of **Center** and **CLEF**, depending on the setting for CLEF range.

Auto False Echo Suppression

If an obstruction is causing a large echo before the material level echo, that echo will rise above the default TVT curve and may be selected as the true echo. Auto False-Echo Suppression modifies the TVT curve so that the false echo will not rise above the TVT curve.

When you use Auto False Echo Suppression, the device first learns the echo profile at that moment¹⁾. A learned TVT curve follows the echo profile and rises above the false echo. You set Auto Suppression Range so that the learned profile replaces the default TVT curve up to a point past the obstruction. From that point on, the default TVT curve is used. The material level echo rises above this, and is selected as the true echo.

Example after Auto False Echo Suppression

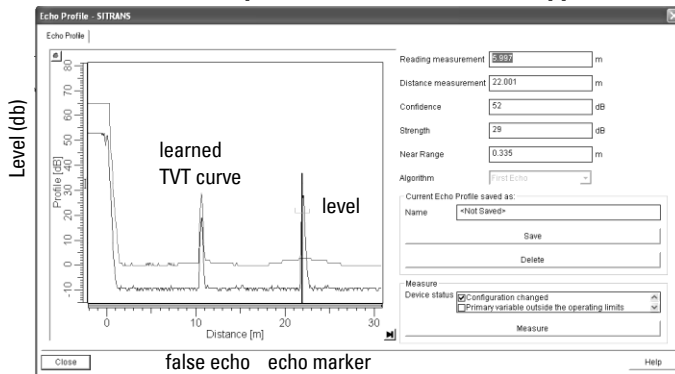

Measurement Range

Near Range

2.2.1.12. *Near Range* programs SITRANS LR260 to ignore the zone in front of the antenna. The default blanking distance is 50 mm (1.97") from end of horn antenna.

Near Range allows you to increase the blanking value from its factory default. But 2.2.5.2 *Auto False Echo Suppression* is generally recommended in preference to extending the blanking distance from factory values.

¹⁾ Use Auto False Echo Suppression when the material level is substantially lower than process full level (ideally when the tank is empty or almost empty).

Far Range

In applications where the base of the vessel is conical or parabolic, a reliable echo may be available below the vessel empty distance, due to an indirect reflection path. Increasing the range extension to 30% or 40% can provide stable empty vessel readings.¹⁾

Measurement Response

The measurement response (response rate) limits the maximum rate at which the display and output respond to changes in the measurement. Once the real process fill/empty rate (m/s) is established, a response rate can be selected that is slightly higher than the application rate. The response rate automatically adjusts the filters that affect the output response rate.

There are three preset options: slow, medium, and fast.

2.2.7.2. Fill Rate (FILL RATE/MIN)	2.2.7.2. Fill Rate (FILL RATE/MIN) 2.2.7.3. Empty rate (EMPTY RATE/MIN)	2.2.4.2.1. Echo Lock	2.4.1. Fail-safe Timer (time in min.)	2.2.4.3.2. Damping Filter
Slow	0.1 m/min	MAX. VERIFICATION	100	60
Medium	1 m/min	MAX. VERIFICATION	10	10
Fast	* 10 m/min	MAX. VERIFICATION	1	0

mA Output

The mA output is proportional to the level, in the range 4 to 20 mA. Generally, the output is set so that the output for 0% is 4 mA, and the output for 100% is 20 mA. 0 and 100% are percentages of the full-scale reading (m, cm, mm, ft, in).

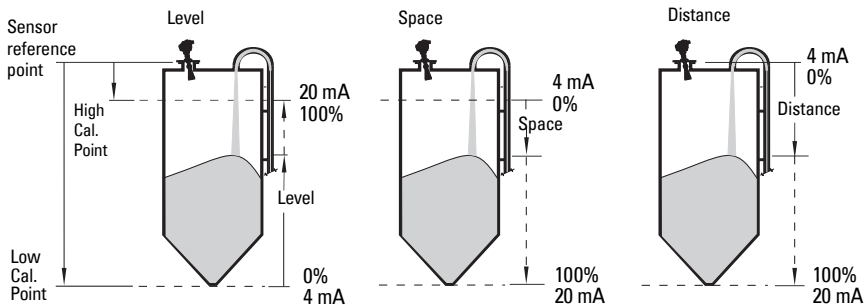

When SITRANS LR260 is put into **PROGRAM** mode it stops responding to the process. It stores the most recent measurement, and holds the associated readings and mA signal output. The instrument reverts to the parameter last addressed during the previous program session.

¹⁾ On 30 m vessel, range extension cannot exceed 31.5 m.

When the instrument is returned to **Measurement** mode, the transceiver resumes operation. The reading and mA output default to the last measurement taken. The reading and associated outputs migrate to the current process level at a rate controlled by the response rate (2.2.71).

If SITRANS LR260 is left in **PROGRAM** mode for 10 minutes without input, it automatically reverts to **Measurement** mode.

Damping

A damping filter smooths out the response to a sudden change in level. This is an exponential filter and the engineering unit is always in seconds. The setting can be modified in 2.2.4.3.2. *Damping Filter*.

Damping example

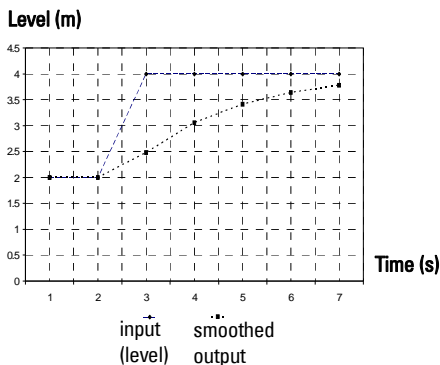

time constant = 2 seconds
input (level) change = 2 m

In 5 time constants the output rises exponentially:
from 63.2% of the change in the first time constant, to almost 100% of the change by the end of the 5th time constant.

Loss of Echo (LOE)

A loss of echo (LOE) occurs when the calculated measurement is judged to be unreliable because the echo confidence value has dropped below the echo confidence threshold.

If the LOE condition persists beyond the time limit set in 2.4.1. *Fail-safe Timer* the LCD displays the Maintenance Required icon, and the text region displays the fault code **S: 0** and the text LOE.

If two faults are present at the same time, the fault code, error text, and error icon for each fault are displayed alternately. For example, Loss of Echo and Fail-safe High.



S: 0 LOE



S: 52 FAIL-SAFE

Fail-safe Mode

The purpose of the Fail-safe setting is to put the process into a safe mode of operation in the event of a fault or failure. The value to be reported in the event of a fault is selected so that a loss of power or loss of signal triggers the same response as an unsafe level.

Fail-safe Timer

Fail-safe Timer determines the time to elapse after the last valid reading before a Fail-safe state is activated. Fail-safe Material Level determines the level to be reported when the Fail-safe timer expires. Upon receiving a reliable echo, the loss of echo condition is aborted, the Service Required icon and error message are cleared, and the reading and mA output return to the current level.

Fail-safe Material Level

When the *2.4.1. Fail-safe Timer* expires, the material level to be reported is determined by *2.4.2. Fail-safe Material Level (FAILSAFE MAT. LE)*.

Fail-safe Material Level	
HI	Use Maximum mA Limit as material level
LO	Use Minimum mA Limit as material level
HOLD	Level remains at last reading
VALUE	User-selected value as defined in Fail-safe Level

Fail-safe Level

When Fail-safe Material level is set to Value, the Fail-safe Level defines a user-defined level to report when the Fail-safe timer expires..

Fail-safe Level	
Values	3.6 to 22.6 mA

Process Pressure/Temperature derating curves

Notes:

- The Process Device Tag shall remain with the process pressure boundary assembly¹. In the event the instrument package is replaced, the Process Device Tag shall be transferred to the replacement unit.
- SITRANS LR260 units are hydrostatically tested, meeting or exceeding the requirements of the ASME Boiler and Pressure Vessel Code and the European Pressure Equipment Directive.
- The serial numbers stamped in each process connection body, (flange, threaded, or sanitary), provide a unique identification number indicating date of manufacture. Example: MMDDYY – XXX (where MM = month, DD = day, YY = year, and XXX= sequential unit produced
Further markings (space permitting) indicate flange configuration, size, equivalent pressure class, material, and material heat code.



WARNINGS:

- **Never attempt to loosen, remove or disassemble process connection or instrument housing while vessel contents are under pressure.**
- **This product is designated as a Pressure Accessory per Directive 97/23/EC and is not intended for use as a safety device.**
- **Materials of construction are chosen based on their chemical compatibility (or inertness) for general purposes. For exposure to specific environments, check with chemical compatibility charts before installing.**
- **The user is responsible for the selection of bolting and gasket materials which will fall within the limits of the flange and its intended use and which are suitable for the service conditions.**
- **Improper installation may result in loss of process pressure and/or release of process fluids and/or gases.**

¹⁾ The process pressure boundary assembly comprises the components that act as a barrier against pressure loss from the process vessel: that is, the combination of process connection body and emitter, but normally excluding the electrical enclosure.

Horn Antenna

2" (50 mm), 3" (80 mm), 4" (100 mm), and 6" (150 mm)
Flanged Versions

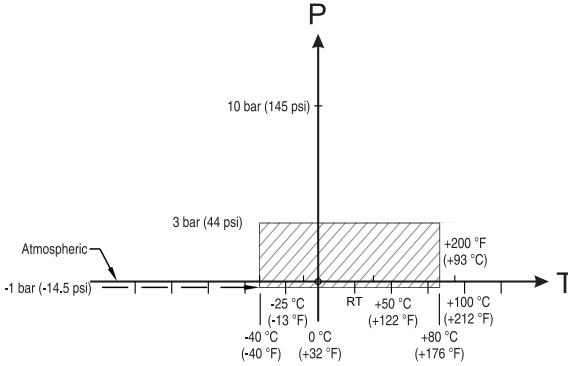

Process Connection Series:

- 51262 or 51263 series flange.
- Ensure your instrument has the process identification Tag showing one of this series, and 25589 stamped on flange.

Pressure/Temperature Curve SITRANS LR260 (7ML5427) Universal Flanged Process Connections

P = Permitted Operating Pressures

T = Permitted Operating Temperature

! WARNING: Never attempt to loosen, remove or disassemble process connection or instrument housing while vessel contents are under pressure.

Loop power

Typical Connection Drawing

Note: Loop voltage is the voltage at the terminals of the power supply (not the voltage at the terminals of the device).

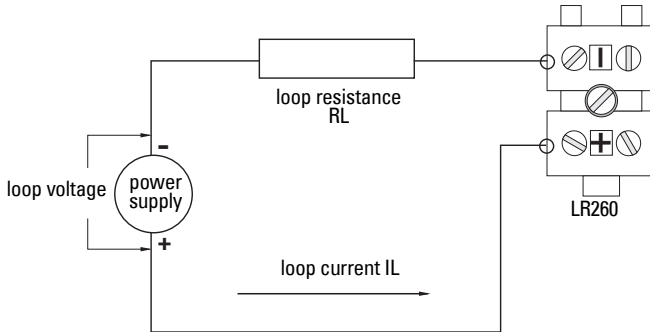

Allowable operating area of SITRANS LR260

Loop Voltage versus Loop Resistance

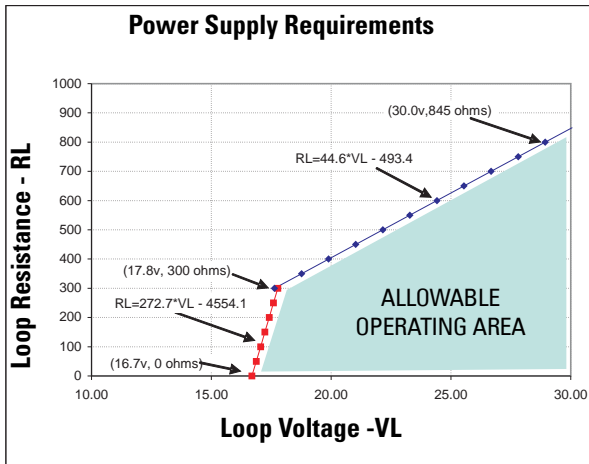

Startup Behavior

Notes:

- SITRANS LR260 is designed to start reliably with a power supply capable of delivering at least 25 mA.
- When connected to a power supply with a current limit of < 25 mA, the LR260 may not start reliably.

Typical Startup Current

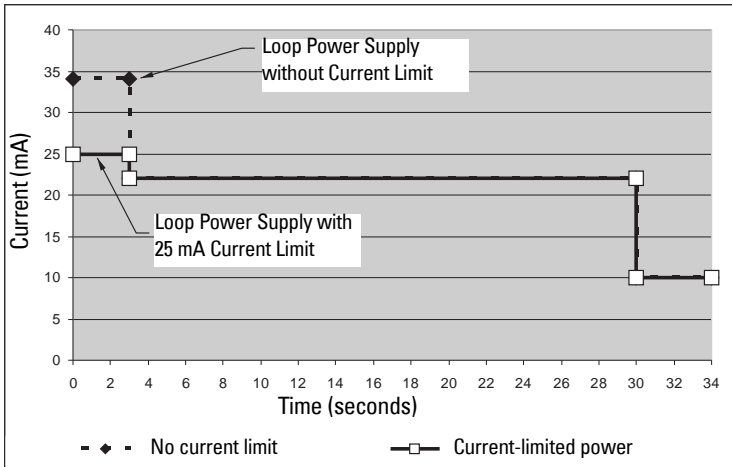

Appendix E: Application Example

Note: In the applications illustrated below, values are for example purposes only.

You can use this example as setup references. Enter the values in the parameter tables to select the corresponding functions.

Configure the basic settings using the Quick Start wizard parameters. (These parameters are inter-related, and changes take effect only after you select **YES** in step 7 to apply changes.)

In each example, after performing a Quick Start, navigate to the other required parameters (either via the handheld programmer, or via SIMATIC PDM) and enter the appropriate values.

Flour in steel storage vessel, level measurement

Note: Minimum distance from flange face to target is limited by 2.2.1.12. *Near Range*.

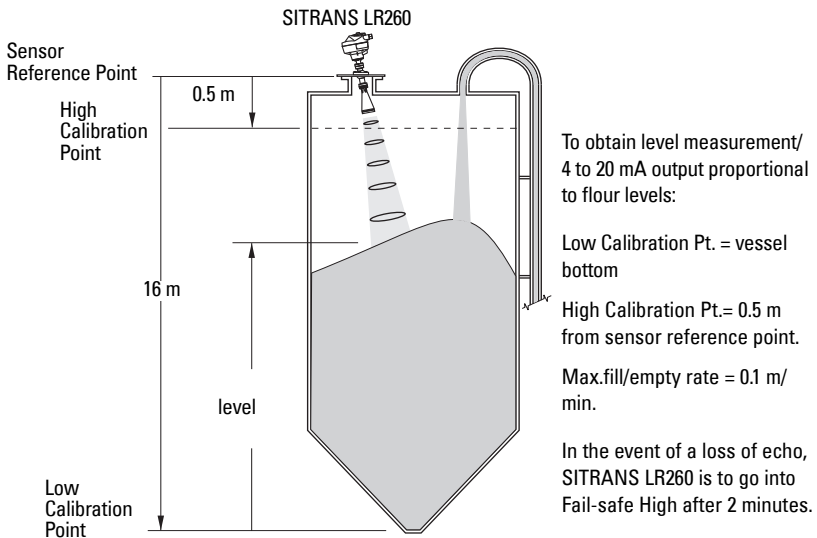

Parameter type	Parameter No. and Name	Options/ Values	Function
Quick Start Wizard parameters	1.1. <i>Application Type</i>	STEEL	
	1.2. <i>Response Rate</i>	SLOW	Slow =0.1 m/minute
	1.3. <i>Units</i>	M	meters
	1.4. <i>Operation</i>	LEVEL	Level
	1.5. <i>Low Calibration Point (LOW CALIB. PT.)</i>	16	16 m
	1.6. <i>High Calibration Point (HIGH CALIB. PT.)</i>	0.5	0.5 m
	1.7. <i>Apply? (Apply changes)</i>	YES	Transfers Quick Start settings to device.
Independent parameters	2.4.1. <i>Fail-safe Timer</i>	2	2 minutes
	2.4.2. <i>Fail-safe Material Level (FAILSAFE MAT. LE)</i>	HI	Failsafe level set to High

Return to **Measurement**: press **Mode**  to start normal operation.

Appendix F: HART Communications

Highway Addressable Remote Transducer, HART, is an industrial protocol that is superimposed on the 4-20 mA signal. It is an open standard, and full details about HART can be obtained from the HART Communication Foundation at www.hartcomm.org

SITRANS LR260 can be configured over the HART network using either the HART Communicator 375 by Fisher-Rosemount, or a software package. The recommended software package is the SIMATIC Process Device Manager (PDM) by Siemens.

SIMATIC PDM

This software package is designed to permit easy configuration, monitoring, and troubleshooting of HART devices. The HART EDD for SITRANS LR260 was written with SIMATIC PDM in mind and has been extensively tested with this software.

For more information, see *Operating via SIMATIC PDM* on page 36.

HART Electronic Device Description (EDD)

In order to configure a HART device, the configurator must have the HART Electronic Device Description for the instrument in question. HART DDs are controlled by the HART Communication Foundation. Please check with the HART Communication Foundation for the availability of the HART EDD for SITRANS LR260. Older versions of the library will have to be updated in order to use all the features of SITRANS LR260.

HART Version

SITRANS LR260 conforms to HART rev. 5.

HART Burst Mode

SITRANS LR260 does not support burst mode.

HART Multidrop

We do not recommend the use of HART multidrop.

HART Communicator 375 Menu Structure

Note: HART Communicator 375 is supported by SITRANS LR260 HART. The menu structure is aligned with the menu structure of SIMATIC PDM.

SITRANS LR260

Identification

- Tag
- Description
- Message
- Installation Date
- Device order number

Setup

- Device
 - Firmware Revision
 - Loader Revision
 - Hardware Revision
- Input
 - Sensor Calibration
 - Antenna
 - Sensor Units
 - Operation
 - Low Calibration Pt.
 - High Calibration Pt.
 - Limit Sensor Value
 - Near Range
 - Far Range
 - Sensor Offset
 - Echo Processing
 - Echo Select
 - Algorithm
 - Position Detect
 - Echo Threshold
 - Echo Marker
 - Sampling
 - Echo Lock
 - Sampling up
 - Sampling down
 - Window
 - Filtering
 - Damping filter
 - Narrow Echo Filter
 - Reform Echo
 - Noise
 - Echo confidence
 - Echo strength
 - Noise Average
 - TVT Setup
 - TVT Hover Level
 - Auto False Echo Suppression
 - Auto Suppression Range
 - Shaper Mode
 - TVT type

TVT Shaper

- Shaper 1-9 (Shaper Points 1-9)
- Shaper 10-18 (Shaper Points 10-18)
- Shaper 19-27 (Shaper Points 19-27)
- Shaper 28-36 (Shaper Points 28-36)
- Shaper 37-40 (Shaper Points 37-40)

Rate

- Response Rate
- Fill Rate per minute
- Empty Rate per minute

Output

mA Output

- mA output function
- 4 mA setpoint
- 20 mA setpoint
- Minimum mA limit
- Maximum mA limit

Fail-Safe

- Failsafe timer
- Failsafe Material level
- Failsafe Level

Diagnostics

Measured Values

- Current Internal Temp
- Max Internal Temp
- Min Internal Temp

Remaining Device Lifetime

- Total Device Operating Time
- Remaining Device Lifetime
- Maintenance Required Limit
- Maintenance Demanded Limit
- Maintenance Alert Activation
- Device Lifetime Maintenance Acknowledge
- Total Expected Device Life

Remaining Sensor Lifetime

- Total Sensor Operating Time
- Remaining Sensor Lifetime
- Maintenance Required Limit
- Maintenance Demanded Limit
- Maintenance Alert Activation
- Sensor Lifetime Maintenance Acknowledge
- Total Expected Sensor Life

Service

LCD Fast Mode

LCD Contrast

Service Interval

- Time Elapsed Since Last Service
- Remaining Lifetime
- Maintenance Required Limit
- Maintenance Demanded Limit
- Maintenance Alert Activation
- Service Acknowledge
- Total Service Interval

Calibration Interval

Time Elapsed Since Last Calibration
Remaining Lifetime
Maintenance Required Limit
Maintenance Demanded Limit
Maintenance Alert Activation
Calibration Acknowledge
Total Calibration Interval

Communication

Communication control

Security

Lock
Unlock value

Language

Language

Supported HART Commands

SITRANS LR260 conforms to HART rev. 5 and supports the following:

Universal Commands

0, 1, 2, 3, 6, 7, 8, 11, 12, 13, 14, 15, 16, 17, 18, 19, 20, 21, 22

Common Practice Commands

33, 34, 35, 36, 37, 38, 40, 41, 42, 44, 45, 46, 48, 50, 51, 53, 54, 59

Device Specific Commands

Command 150	Read Echo Summary
Command 151	Read Echo Data Profile
Command 160	Updated Read Echo Summary
Command 166	Read Failsafe
Command 167	Write Failsafe
Command 170	Read Echo Lock
Command 171	Write Echo Lock
Command 172	Read TVT
Command 173	Write TVT
Command 174	Read TVT Shaper
Command 175	Write TVT Shaper
Command 178	Read Analog Special
Command 179	Write Analog Special
Command 182	Read Range Calibration
Command 183	Write Range Calibration
Command 186	Read Wear
Command 206	Read Confidence
Command 207	Write Confidence Threshold
Command 208	Read Local Display Commands
Command 209	Write Local Display Commands

Universal and Common Practice Commands

For details on the Universal and Common Practice Commands, please contact the HART Communication Foundation.

Device Specific Commands

For a document containing the Device Specific Commands, please contact Siemens Milltronics at techpubs.smpi@siemens.com.

Appendix G: Firmware Revision History

Firmware Rev.	EDD Rev.	Date	Changes
1.00.01	1.00.04	Dec. 5, 2007	<ul style="list-style-type: none">Initial release

G: Firmware Revision

Glossary

- accuracy:** degree of conformity of a measure to a standard or a true value.
- algorithm:** a prescribed set of well-defined rules or processes for the solution of a problem in a finite number of steps.
- ambient temperature:** the temperature of the surrounding air that comes in contact with the enclosure of the device.
- antenna:** an aerial which sends out and receives a signal in a specific direction. There are four basic types of antenna in radar level measurement, horn, parabolic, rod, and waveguide.
- attenuation:** a term used to denote a decrease in signal magnitude in transmission from one point to another. Attenuation may be expressed as a scalar ratio of the input magnitude to the output magnitude or in decibels.
- Auto False-Echo Suppression:** a technique used to adjust the level of a TVT curve to avoid the reading of false echoes. (See TVT.)
- Auto False-Echo Suppression Distance:** defines the endpoint of the TVT distance. (See TVT.) This is used in conjunction with auto false echo suppression.
- beam width:** the angle diametrically subtended by the one-half power limits (-3 dB) of the microwave beam.
- beam spreading:** the divergence of a beam as it travels through a medium.
- blanking:** a blind zone extending away from the reference point plus any additional shield length. The instrument is programmed to ignore this zone.
- capacitance:** the property of a system of conductors and dielectrics that permits the storage of electricity when potential differences exist between the conductors. Its value is expressed as the ratio of a quantity of electricity to a potential difference, and the unit is a Farad.
- confidence:** see **Echo Confidence:** describes the quality of an echo. Higher values represent higher quality. Confidence threshold defines the minimum value.
- damping:** term applied to the performance of an instrument to denote the manner in which the measurement settles to its steady indication after a change in the value of the level.
- dB (decibel):** a unit used to measure the amplitude of signals.

derating: to decrease a rating suitable for normal conditions according to guidelines specified for different conditions.

dielectric: a nonconductor of direct electric current.¹⁾

dielectric constant (dK): the ability of a dielectric to store electrical potential energy under the influence of an electric field. Also known as Relative Permittivity. An increase in the dielectric constant is directly proportional to an increase in signal amplitude. The value is usually given relative to a vacuum /dry air: the dielectric constant of air is 1¹.

echo: a signal that has been reflected with sufficient magnitude and delay to be perceived in some manner as a signal distinct from that directly transmitted. Echoes are frequently measured in decibels relative to the directly transmitted signal.

Echo confidence: describes the quality of an echo. Higher values represent higher quality. Echo threshold defines the minimum value required for an echo to be accepted as valid and evaluated.

Echo Lock Window: a window centered on an echo in order to locate and display the echo's position and true reading. Echoes outside the window are not immediately processed.

Echo Marker: a marker that points to the processed echo.

Echo Processing: the process by which the radar unit determines echoes.

Echo Strength: describes the strength of the selected echo in dB referred to 1 μ V rms.

Echo Profile: a graphical display of a processed echo.

false echo: any echo which is not the echo from the desired target. Generally, false echoes are created by vessel obstructions.

frequency: the number of periods occurring per unit time. Frequency may be stated in cycles per second.

Hertz (Hz): unit of frequency, one cycle per second. 1 Gigahertz (GHz) is equal to 10⁹ Hz.

HART: Highway Addressable Remote Transducer. An open communication protocol used to address field instruments.

horn antenna: a conical, horn-shaped antenna which focuses microwave signals. The larger the horn diameter, the more focused the radar beam.

inductance: the property of an electric circuit by virtue of which a varying current induces an electromotive force in that circuit or in a neighboring circuit. The unit is a Henry.

microwaves: the term for the electromagnetic frequencies occupying the portion of the radio frequency spectrum from 1 GHz to 300 GHz.

¹⁾ Many conductive liquids/electrolytes exhibit dielectric properties; the relative dielectric constant of water is 80.

multiple echoes: secondary echoes that appear as double, triple, or quadruple echoes in the distance from the target echo.

Near Blanking: see Blanking

nozzle: a length of pipe mounted onto a vessel that supports the flange.

parameters: in programming, variables that are given constant values for specific purposes or processes.

polarization: the property of a radiated electromagnetic wave describing the time-varying direction and amplitude of the electric field vector.

polarization error: the error arising from the transmission or reception of an electromagnetic wave having a polarization other than that intended for the system.

propagation factor (pf): where the maximum velocity is 1.0, pf is a value that represents a reduction in propagation velocity as a result of the wave travelling through a pipe or medium.

pulse radar: a radar type that directly measures distance using short microwave pulses. Distance is determined by the return transit time.

radar: radar is an acronym for **RA**dio **D**etection **A**nd **R**anging. A device that radiates electromagnetic waves and utilizes the reflection of such waves from distant objects to determine their existence or position.

range: distance between a transmitter and a target.

range extension: the distance below the zero percent or empty point in a vessel.

relative humidity: the ratio of the actual amount of moisture in the atmosphere to the maximum amount of moisture the atmosphere could hold (which varies depending on the air temperature).

relative permittivity: see dielectric constant.

repeatability: the closeness of agreement among repeated measurements of the same variable under the same conditions.

shot: one transmit pulse or measurement.

speed of light: the speed of electromagnetic waves (including microwave and light) in free space. Light speed is a constant 299, 792, 458 meters per second.

stillpipe: a pipe that is mounted inside a vessel parallel to the vessel wall, and is open to the vessel at the bottom.

stilling-well: see **stillpipe**.

two wire radar: a low-energy radar. Can be loop powered, analog, intrinsically safe 4 to 20 mA, or a digital (BUS) transmitter.

TVT (time varying threshold): a time-varying curve that determines the threshold level above which echoes are determined to be valid.

waveguide antenna: a hollow, metallic tube that transmits a microwave signal to the product target.

Index

A

Abbreviations and Identifications

list 4

activating LR260 26

analog output

fail signal 7

in Measure mode 99

load 7

signal range 7

approvals 8

Auto False Echo Suppression

explanation 98

setup 59

via PDM 43

B

beam angle

values 12

blanking (see Near Range) 98

C

cables

requirements 20

cleaning

instructions 95

communication

load 7

max. line length 7

conduits

requirements 20

D

device description

HART 109

dimensions table

threaded horn 12

E

echo confidence

parameter setup 58

echo profile viewing

via LUI 32

via PDM 42

edit mode

handheld programmer 30

key functions 31

enclosure

opening 20

F

factory defaults

device reset via LUI 73

device reset via PDM 47

Fail-safe

settings 66

Fail-safe Timer

explanation 101

Far Range

explanation 99

setup 54

function keys

measurement mode 28

navigation mode 30

H

handheld programmer

edit mode 30

measurement mode 28

navigation 30

HART

device description 109

HART Communications

details 109

HART version 7

I

Identifications and Abbreviations

list 4

K

key functions

edit mode 31

L

LCD display

contrast adjustment 74

echo profile viewing 32

fast mode 74

measurement mode 26

PROGRAM mode 27

level application example

via LUI 35

level trend viewing

via PDM 45

lid-lock set screw 20

loop voltage vs. loop resistance

power supply requirements 22

Loss of Echo (LOE)

explanation 100

M

mA output in Measure mode 99

- maintenance 46
 - cleaning 95
- maintenance settings 67
- Measurement Response
 - explanation 99
- mounting
 - handheld programmer access 15
 - housing construction 15
 - nozzle design 14
 - nozzle location 14
 - on vessel with obstructions 15
 - sunshield recommended 15
- N**
- Near Range
 - explanation 98
- O**
- operating principles 96
- P**
- parameter settings
 - adjust via PDM 36
- performance
 - specifications 6
- polarization reference point 15
- power 6
- power source
 - requirements 20
- power supply requirements
 - loop voltage vs. loop resistance 22
- programmer
 - handheld 28
- Q**
- Quick Start
 - launching via PDM 38
- Quick Start Wizard
 - via LUI 32
 - via SIMATIC PDM 37
- R**
- range extension
 - see Far Range 99
- reset
 - factory defaults via LUI 73
 - factory defaults via PDM 47
- S**
- settings
 - adjust parameters via LUI 30
 - adjust parameters via PDM 36
- SIMATIC PDM 36
 - features of rev. 6.0 36
 - Quick Start 38
- simulate analog output 48

- SITRANS LR260
 - operating principles 96
 - overview 5
- specifications 6
 - ambient temperature 8
 - antenna 7
 - enclosure 7
 - environmental 8
 - performance 6
 - power 6
 - pressure 8
 - process connections 7
 - process temperature 8
 - weight 7

- T**
- technical support
 - contact information 3
- temperature de-Rating
 - curves 102
- terminals
 - accessing 20
- trend diagram
 - level trend viewing 45
- troubleshooting
 - communications 87
 - operation 93
- TVT curve 98
- TVT Shaper
 - manual adjustment via PDM 45
- W**
- wiring
 - cables 20
 - connecting HART 21

LCD menu structure

LCD menu structure

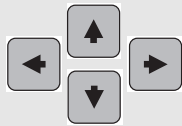

Notes:

- In Navigation mode **ARROW keys** navigate the menu in the direction of the arrow..
- See *See Parameter Reference* on page 43. for detailed information and instructions.

1. QUICK START

- 1.1 APPLICATION TYPE
- 1.2 RESPONSE RATE
- 1.3 UNITS
- 1.4 OPERATION
- 1.5 LOW CALIB. PT.
- 1.6 HIGH CALIB. PT.
- 1.7 APPLY?

2. SETUP

- 2.1 DEVICE
 - 2.1.1 FIRMWARE REV
 - 2.1.2 LOADER REV
 - 2.1.3 HARDWARE REV
- 2.2 INPUT
 - 2.2.1 SENSOR CALIB.
 - 2.2.1.1 ANTENNA
 - 2.2.1.4 SENSOR UNITS
 - 2.2.1.5 OPERATION
 - 2.2.1.6 LOW CALIB. PT.
 - 2.2.1.7 HIGH CALIB. PT.
 - 2.2.1.8 LIMIT SENS VALUE
 - 2.2.1.12 NEAR RANGE
 - 2.2.1.13 FAR RANGE
 - 2.2.1.25 SENSOR OFFSET
 - 2.2.4 ECHO PROC.
 - 2.2.4.1 ECHO SELECT
 - 2.2.4.1.1 ALGORITHM
 - 2.2.4.1.2 POSITION
 - 2.2.4.1.3 ECHO THRESHOLD
 - 2.2.4.1.5 ECHO MARKER
 - 2.2.4.2 SAMPLING
 - 2.2.4.2.1 ECHO LOCK
 - 2.2.4.2.4 UP SAMP.
 - 2.2.4.2.5 DOWN SAMP.
 - 2.2.4.2.6 WINDOW
 - 2.2.4.3 FILTERING
 - 2.2.4.3.2 DAMPING FILTER
 - 2.2.4.3.6 NARROW ECHO FIL.
 - 2.2.4.3.7 REFORM ECHO
 - 2.2.4.5 NOISE
 - 2.2.4.5.1 CONFIDENCE
 - 2.2.4.5.2 STRENGTH
 - 2.2.4.5.3 NOISE AVERAGE
- 2.2.5 TVT SETUP

- 2.2.5.1 TVT HOVER LEVEL
- 2.2.5.2 AUTO ECHO SUPP
- 2.2.5.3 AUTO SUPP RANGE
- 2.2.5.4 SHAPER MODE
- 2.2.5.6 TVT TYPE

2.2.6 TVT SHAPER

- 2.2.6.1 SHAPER 1-9
- 2.2.6.2 SHAPER 10-18
- 2.2.6.3 SHAPER 19-27
- 2.2.6.4 SHAPER 28-36
- 2.2.6.5 SHAPER 37-40

2.2.7 RATE

- 2.2.7.1 RESPONSE RATE
- 2.2.7.2 FILL RATE /MIN
- 2.2.7.3 EMPTY RATE /MIN

2.2.8 TB VALUES

- 2.2.8.2 LEVEL MEAS.
- 2.2.8.3 SPACE MEAS.
- 2.2.8.4 DISTANCE MEAS.

2.3 OUTPUT

2.3.1 MA OUTPUT

- 2.3.1.1 MA OUTPUT VALUE
- 2.3.1.2 MA OUTPUT FUNC.
- 2.3.1.3 4 MA SETPOINT
- 2.3.1.4 20 MA SETPOINT
- 2.3.1.5 MIN. MA LIMIT
- 2.3.1.6 MAX. MA LIMIT
- 2.3.1.7 4 MA OUTPUT TRIM
- 2.3.1.8 20 MA OUTPUT TRIM

2.4 FAILSAFE

- 2.4.1 FAILSAFE TIMER
- 2.4.2 FAILSAFE MAT. LE
- 2.4.4 FAILSAFE LEVEL

3. DIAGNOSTICS

- 3.1 ECHO PROFILE
- 3.14 MEAS. VALUES
 - 3.14.1 CURR. INTERN. TEMP.
 - 3.14.2 MAX. INTERN. TEMP.
 - 3.14.3 MIN. INTERN. TEMP.
- 3.15 REMAIN. DEV. LIFE
 - 3.15.1 TOTAL OP-TIME
 - 3.15.2 REMAIN. LIFETIME

- 3. **DIAGNOSTICS**
 - (cont'd)
 - 3.15.3 MAINT REQ LIMIT
 - 3.15.4 MAINT DEM LIMIT
 - 3.15.5 ALERT ACTIVATION
 - 3.15.6 TOTAL EXP. LIFE
 - 3.15.7 MAINT STAT
 - 3.15.8 ACK STATUS
 - 3.15.9 ACK
 - 3.16 REMAIN. SENS. LIFE
 - 3.16.1 SENSOR OP-TIME
 - 3.16.2 REMAIN. LIFETIME
 - 3.16.3 MAINT REQ LIMIT
 - 3.16.4 MAINT DEM LIMIT
 - 3.16.5 ALERT ACTIVATION
 - 3.16.6 TOTAL EXP. LIFE
 - 3.16.7 MAINT STAT
 - 3.16.8 ACK STATUS
 - 3.16.9 ACK

- 4. **SERVICE**
 - 4.1 DEVICE RESET
 - 4.2 MANUF. DATE
 - 4.3 LCD FAST MODE
 - 4.4 LCD CONTRAST
 - 4.6 POWERED HOURS
 - 4.9 POWERON RESETS
 - 4.11 MEM. TEST
 - 4.16 SERVICE INTERVAL
 - 4.16.1 TIME LAST SERV
 - 4.16.2 REMAIN LIFETIME
 - 4.16.3 MAINT REQ LIMIT
 - 4.16.4 MAINT DEM LIMIT
 - 4.16.5 ALERT ACTIVATION
 - 4.16.6 SERVICE INTERVAL
 - 4.16.7 MAINT STAT
 - 4.16.8 ACK STATUS
 - 4.16.9 ACK
 - 4.17 CALIB. INTERVAL
 - 4.17.1 TIME LAST CAL.
 - 4.17.2 REMAIN LIFETIME
 - 4.17.3 MAINT REQ LIMIT
 - 4.17.4 MAINT DEM LIMIT
 - 4.17.5 ALERT ACTIVATION
 - 4.17.6 TOTAL CALIB.INTRV
 - 4.17.7 MAINT STAT
 - 4.17.8 ACK STATUS
 - 4.17.9 ACK

- 5. **COMMUNICATION**
 - 5.1 DEVICE ADDRESS
 - 5.2 COMM. CONTROL

- 6. **SECURITY**
 - 6.1 LOCK
 - 6.2 UNLOCK VALUE

- 7. **LANGUAGE**

For more information

www.siemens.com/level

www.siemens.com/continuous-weighing

Siemens AG
Industry Sector
1954 Technology Drive
P.O. Box 4225
Peterborough, ON
Canada K9J 7B1

email: techpubs.smpi@siemens.com

www.siemens.com/processautomation

Subject to change without prior notice
A5E32337683 Rev. AA

© Siemens AG 2013



A 5 E 3 2 3 3 7 6 8 3
Printed in Canada